



**Waterloo Region  
District School Board**

## **REQUEST FOR TENDER**

**24-7556-RFT**

**Waterloo-Oxford District Secondary School  
Family Studies Renovation & HVAC Upgrades**

**ISSUE DATE: MARCH 28, 2024**

**ELECTRONIC SUBMISSIONS will be received by the Bidding System no later than  
2:00 p.m. local time, on APRIL 18, 2024.**

---

**DIVISION 00 – BIDDING AND CONTRACT DOCUMENTS**

00 01 00 – Consultant/Professional Seals..... 1  
00 21 13 – Instructions to Bidders ..... 12  
00 21 14 – General Contractors and Subcontractors..... 2  
00 21 15 – Scope of Work ..... 1  
00 31 34 – Subsurface Investigation Report – Not Applicable ..... 1  
**Appendix 00 31 34A – Soil Report – Not Applicable ..... 1**  
00 41 13A – Asset and Warranty Card ..... 1  
00 41 73 – Supplementary Bid Information..... 1  
00 56 13 – Definitions Stipulated Price..... 2  
00 72 13 – Standard Terms and Conditions..... 34  
00 73 00 – The Supplementary Conditions..... 59

**DIVISION 01 - GENERAL REQUIREMENTS**

01 14 00 – Work Restrictions ..... 2  
01 19 00 - Specifications and Documents..... 2  
01 21 00 – Allowances ..... 2  
01 31 00 – Project Managing And Coordination..... 6  
01 32 00 – Construction Progress Documentation ..... 3  
01 33 00 – Submittal Procedures ..... 5  
01 35 17 – Fire Safety Procedures ..... 7  
Appendix 013517-A Contractor Hot Work Permit ..... 1  
01 35 23 – Health And Safety..... 5  
01 35 43 – Hazardous Materials ..... 4  
Appendix 01 35 43A Asbestos Audit Update Report ..... 69  
01 42 00 – References..... 5  
01 45 00 – Quality Control ..... 7  
01 51 00 – Temporary Utilities..... 5  
01 53 00 – Temporary Construction Facilities ..... 6  
01 54 00 – Materials and Equipment..... 3  
01 61 00 – Product Requirements ..... 5  
01 70 00 - Examination and Preparation..... 3  
01 73 30 - Execution and Cutting and Patching..... 4  
01 74 00 – Cleaning and Waste Management ..... 4  
01 78 10 – Closeout Submittals and Requirements..... 6  
01 78 40 – Maintenance Requirements..... 3  
01 79 00 – Demonstration and Training ..... 3

**DIVISION 02 – EXISTING CONDITIONS**

02 41 19 – SELECTIVE DEMOLITION ..... 3

**DIVISION 03 – CONCRETE**

NOT APPLICABLE

---

**DIVISION 04 – MASONRY**

04 05 10 – COMMON WORK RESULTS FOR MASONRY	4
04 05 12 – MASONRY MORTAR AND GROUT	1
04 22 00 – CONCRETE UNIT MASONRY	1

**DIVISION 05 – METALS**

REFER TO STRUCTURAL DRAWINGS

**DIVISION 06 – WOOD, PLASTICS, AND COMPOSITES**

06 10 10 – ROUGH CARPENTRY	3
06 40 00 – ARCHITECTURAL WOODWORK	10
MILLWORK DETAILS	14

**DIVISION 07 – THERMAL AND MOISTURE PROTECTION**

07 21 16 – BLANKET INSULATION	2
07 81 00 – APPLIED FIREPROOFING	2
07 84 00 – FIRESTOPPING	3
07 92 10 – JOINT SEALING	4

**DIVISION 08 – DOORS AND OPENINGS**

08 44 13 – GLAZED ALUMINUM CURTAIN WALLS	6
08 50 50 – ALUMINUM WINDOWS	5
08 80 50 – GLAZING	4

**DIVISION 09 – FINISHES**

09 21 16 – GYPSUM BOARD ASSEMBLIES	4
09 22 14 – METAL FURRING AND LATHING	2
09 22 16 – NON-STRUCTURAL METAL FRAMING	2
09 22 27 – ACOUSTICAL SUSPENSION	3
09 51 13 – ACOUSTICAL PANEL CEILINGS	2
09 65 16 – RESILIENT FLOORING AND BASE	3
09 91 10 – PAINTING	8

**DIVISION 10 – SPECIALTIES**

10 10 13 – WHITEBOARDS/ TACKBOARDS	2
10 26 10 – WALL PROTECTION AND CORNER GUARDS	1

**DIVISION 20 – MECHANICAL**

REFER TO SPECIFICATIONS BY MNE ENGINEERING INC.	27
---	----

<b>DIVISION 22 – PLUMBING</b> REFER TO SPECIFICATIONS BY MNE ENGINEERING INC.	8
<b>DIVISION 23 – HEATING, VENTILATING AND AIR CONDITIONING</b> REFER TO SPECIFICATIONS BY MNE ENGINEERING INC.	27
<b>DIVISION 25 – INTEGRATED AUTOMATION</b> REFER TO SPECIFICATIONS BY MNE ENGINEERING INC.	10
<b>DIVISION 26 – ELECTRICAL</b> REFER TO SPECIFICATIONS BY MNE ENGINEERING INC.	32
<b>DIVISION 27 – COMMUNICATIONS</b> REFER TO SPECIFICATIONS BY MNE ENGINEERING INC.	6
<b>DIVISION 28 – ELECTRONIC SAFETY AND SECURITY</b> REFER TO SPECIFICATIONS BY MNE ENGINEERING INC.	9

**END OF SECTION**

**00 01 00 Consultant/Professional Seals**

1.1 The following professional seals and signatures are provided as required by Paragraph 1.21.1 (4) Division C of the Ontario Building Code and apply to the areas of expertise for which each consultant was commissioned.

1.1.1 Architect

**CORNERSTONE ARCHITECTURE INCORPORATED**  
110-700 Richmond Street  
London Ontario N6A 5C7  
Phone: 519 432 6644 Fax: 519 432 6737

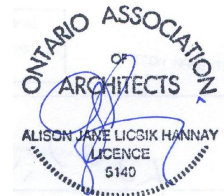

1.1.2 Structural Engineer

**MTE CONSULTANTS INC.**  
123 St. George Street  
London Ontario N6A 3A1  
Phone: 519 204 6510 Fax: 519 204 6511



1.1.3 Mechanical Engineer

**MNE ENGINEERING LTD.**  
22 Kevco Place  
Kitchener Ontario N2C 2G5  
Phone: 519 894 9408 Fax: N/A



1.1.4 Electrical Engineer

**MNE ENGINEERING LTD.**  
22 Kevco Place  
Kitchener Ontario N2C 2G5  
Phone: 519 894 9408 Fax: N/A



**END OF SECTION**

## **00 21 13 Instructions to Bidders**

### **1. Designated Contact**

To contact the Board or ask questions in relation to this Procurement, bidders must initiate the communication electronically through the Bidding System. The Board will not accept any respondent's communications by any other means, except as specifically stated in the Procurement. Bidder's must not communicate in any manner with anyone other than the Designated Contact.

For the purposes of this procurement process, the Designated Contact will be:

Procurement Lead: Ardith Inapan  
Title: Junior Buyer  
Waterloo Region District School Board  
Email: ardith\_inapan@wrdsb.ca

### **2. Consultant**

The Board has hired the following architect/consultant to assist in the preparation of this Tender: **Cornerstone Architecture Incorporated.**

The architect/consultant and any sub consultants are not to be contacted by any interested parties from the bid issue date to the bid award notification. The architect/consultant or any sub consultants will not respond to any direct communication.

The Board will be responsible for the contract administration of the project after the purchase order has been issued or the contract has been signed by the Board

### **3. Blackout Period**

A black out period shall exist between the deadline for questions and the date of award. During this period, there shall be no communication between the Bidders, the Board, or any Board consultants or employees, unless initiated by the Board's Designated Representative, noted above.

### **4. Communication and Question Protocol**

Bidders and their representatives are NOT permitted to contact WRDSB Project Managers/Leads, or agents of the Board; any member of the Board's governing body (such as Board of Trustees, or advisors); any employee, consultant, or agent of the Board's Clients, other than the Designated Contact listed above. Any attempt by a Bidder to bypass or influence the procurement process may result in disqualification of the Bidder and the rejection of the Bidder's submission.

The Board will not be responsible for any verbal statement, instruction, or representations. In case of difference between any verbal information and written

document, the written document shall govern. Information obtained from any source, other than the Designated Representative, noted above in writing, shall not be relied upon.

The Board shall not be bound by any verbal instruction or information provided by any Board employee or consultant of the Board. Only responses provided in an Addendum shall form part of this Procurement Document.

**All requests for information, instructions, or clarifications shall be through the Bidding System by clicking on the “Submit a Question” button found within the bid detail of the specified Procurement. Addenda will be issued accordingly.**

It is the responsibility of the Bidder to seek clarification of any matter that they consider unclear before submitting their application. The Board is not responsible for any misunderstanding of the Procurement documents on the part of the Bidder.

All requests for information, instructions, or clarifications shall be through the Bidding System by clicking on the “Submit a Question” button found within the bid detail of the specified Procurement. Addenda will be issued accordingly.

**5. Doing Business with the Waterloo Region District School Board**

The Waterloo Region District School Board is a provincially funded institution reporting to the Ministry of Education of Ontario and is one of the larger school boards in Ontario, operating 121 school locations and serving approximately 64,000 students in the Region of Waterloo.

The Waterloo Region District School Board’s Vendor Registration program is transitioning to a fully integrated online eProcurement tool for bid opportunities through the electronic bidding system: [bids&tenders](#).

Bid opportunities may be posted as Public or by Invitation only and are based on dollar thresholds outlined in WRDSB Administrative [Procedure 4570 Procurement](#).

The Board utilizes prequalified Roster Lists for specific categories/commodities awarded through a competitive process.

Competitive opportunities including Requests of Prequalification (RFPQ) are posted on the Electronic Bidding System, [bids&tenders/wrdsb](#).

**6. Anticipated Project Schedule**

The following table represents the anticipated project timelines. This timeline is an estimate only and may be subject to change by the Board at any time.

DESCRIPTION	DATE
Issue Date of Tender	March 28, 2024
Non-Mandatory Pre-Bid Site Examination	Date: Tuesday, April 9, 2024 Time: 3:00 PM Waterloo-Oxford District Secondary School 1206 Snyder's Road West Baden ON Designated Meeting Area: Main Entrance
Deadline for Questions	April 15, 2024
Closing Date and Time	April 18, 2024, 2:00 pm local time
Anticipated Contract Start / Work begins	June 22, 2024
Substantial Completion Date	September 27, 2024
Ready for Takeover	September 27, 2024
Deemed Complete Date	October 25, 2024

**7. Pre-Bid Site Examination**

Bidders are strongly encouraged to attend the non-mandatory pre-bid site examination and sign the attendance sheet. Date, time and location are provided above in the Anticipated Project Schedule. The Board may not provide another opportunity to visit the site. However, absence from this site meeting will not disqualify any Bidder.

Bidders shall attend the site meeting at their own risk and hold the Board harmless for any issues or damages arising out of their attendance of the site meeting.

The Owner will not consider any claims for additional payments during the execution of the Work for extra work or difficulties encountered resulting from conditions which were either visible or could be reasonably inferred from an examination of the Place of the Work and the available project information prior to the submission of Bids

Bidders are encouraged to bring their own measuring tape, camera, or other portable tools as required to the site meeting. Bidders are solely responsible for making their own assessment of the site.



**8. Secondary Site Examinations**

Bidder may request a secondary site examination visit through the Bidding System by clicking on the “Submit a Question” button found within the bid details page of that Procurement. Include the contact’s name and email of the person who will visit the site.

Bidders shall attend the secondary site examination visit at their own risk and hold the Board harmless for any issues or damages arising out of their attendance of the site meeting.

Bidders not in attendance of a Mandatory Pre-Bid Site Examination meeting will not be provided an opportunity to a secondary site examination visit.

Bidders must adhere to all communication protocols, as describe in Section 1.0, Sub Section 4. Communication Protocol.

The Owner will not consider any claims for additional payments during the execution of the Work for extra work or difficulties encountered resulting from conditions which were either visible or could be reasonably inferred from an examination of the Place of the Work and the available project information prior to the submission of Bids.

Bidders are encouraged to bring their own measuring tape, camera, or other portable tools as required to the site meeting. Bidders are solely responsible for making their own assessment of the site.

**9. Examination of Bid Documents and Work and Submitting Questions**

- i. Bidders are required to fully acquaint themselves with the Procurement documents; fully inform themselves of all conditions, limitations and requirements involved in the Procurement; and obtain all information that may be necessary to complete those requirements before submitting a Bid.
- ii. Submission of a Bid shall be considered conclusive evidence that the Bidder has satisfied itself as to the requirements of this Procurement.
- iii. In the event a Bidder discovers any errors, discrepancies, inconsistencies, or omissions or requires clarification within this Procurement, they are to submit their observations and/or questions through bids&tenders by clicking on the “Submit a Question” button found within the bid detail of the specified Procurement by the Deadline for Questions specified in this paragraph.
- iv. Bidders are strongly encouraged to ask clear and concise question(s) or statements citing the relevant section of the Bid Solicitation Document. The Board cannot guarantee a response to questions received by the Board after the Deadline for Questions.
- v. The Board has endeavored to provide complete, correct information and estimates to enable Bidders to properly assess and determine the scope and complexity of the Work prior to submitting a Bid.

- vi. Bidders are solely responsible for determining if they require additional information or if anything appears incorrect or incomplete. The onus is on the Bidder to contact the Designated Representative prior to the Deadline for Responses indicated in this document, if they have any questions or queries whatsoever or find omissions from or discrepancies in this Bid Solicitation document, unnecessary restrictions in the terms of reference, or should they be in doubt as to the meaning of any part of this document.
- vii. Written responses or clarifications to issues of substance will be shared with all Bidders in the form of an Addendum.

**10. Electronic Bid Submission Only / Electronic Bidding System**

Competitive opportunities including Requests of Prequalification (RFPQ) are posted on the Electronic Bidding System, [bids&tenders/wrdsb](https://bids&tenders/wrdsb).

The Bidder must submit their bid through the Bidding System only. Any other form of submittal will not be considered. It is the Bidder's responsibility to read the Procurement documents thoroughly including all attachments and addenda, if any, as these contain information that is highly pertinent to this Procurement and to clarify any details with the Designated Representative prior to their submission. To be considered, Bidders must respond to this Procurement.

- i. In order to submit a bid, bidders must be registered with [bids&tenders](https://bids&tenders). The sole onus is on the bidder to have the most current correct information set-up in Bids and Tenders including but not limited to plan taker contact information, categories, and agency.
- ii. All Bids shall be submitted through [bids&tenders](https://bids&tenders) only. The onus is on the Bidder to ensure all requirements of the Bid Solicitations are submitted.
- iii. If the bidder encounters technical issues, the onus is on the bidder to have this resolved prior to the closing date and time by contacting [support@bidsandtenders.ca](mailto:support@bidsandtenders.ca)
- iv. Bidder shall have a "Vendor account" in the Bidding System and shall ensure the account is created with the Bidders full legal company name and be registered as a "plan taker" for this bid solicitation. Only the plan takers will have access to download bid documents, receive addenda email notifications, download addenda and to submit their bid electronically through the Bidding System.
- v. The onus is on the Bidder to ensure that the Bid is received in the Bidding System on or before the Closing Time. The Closing Time shall be determined by the Bidding System's web clock. The timing of the Bid submission shall be based on when the Bid is received by the Bidding System, not when a Bid is submitted by a Bidder.

- vi. Bidders shall allow sufficient time to upload their Bid submission including all requirements as stated in this Procurement and to resolve any issues that may arise as Bid transmission can be delayed in an “internet traffic jam” due to file transfer size, transmission speed, and other electronic considerations.
- vii. All prices including provisional/supplementary pricing, if requested, shall be submitted in the Schedule of Prices forms available through the Bidding System.
- viii. The Owner reserves the right to accept or reject any or all provisional bid prices submitted, and such prices shall remain in effect for the duration of the Contract. Failure to submit provisional prices where required may result in the Bid being declared non-compliant.
- ix. Bids submitted by fax or paper copy, or any other format will not be accepted.
- x. The Bidding System will not accept Bids after the Closing Time as determined by the Bidding System’s web clock.
- xi. The Board hereby consent to the use of an Electronic Signature for the signing of all documents requested hereunder. Acceptable forms of signatures include, but are not limited to, the typing of the Bidder’s authorized signing officer’s name or the inclusion of an image of the Bidder’s authorized signing officer’s signature, so long as the electronic signature is sufficient to identify the Bidder’s authorized signing officer. The Bidder’s authorized signing officer agrees that whatever form of electronic signature is provided constitutes a signature for the purpose of executing all documents requested hereunder.
- xii. Upon submitting a Bid, the Bidding System will send a confirmation email to the Bidder advising that the Bid was submitted successfully. If a Bidder does not receive a confirmation email despite submitting a Bid, the Bidder should contact technical support of the service provider hosting the Bidding System via email: [support@bidsandtenders.ca](mailto:support@bidsandtenders.ca)
- xiii. There will be no public opening for this Bid.
- xiv. If a Bid is a joint submission of two (2) or more firms, a single Bid is to be coordinated and submitted by the lead Bidder with the required information. If two or more parties submitted a joint response to this Bid Solicitation, they shall decide between them who is to be the Bidder, without any involvement of the Board.
- xv. Your online Bid submission shall be taken as your statement that you understand the requirements and agree to comply with the requirements as well as terms and conditions stated in this Bid Solicitation document, including Board’s Standard Terms and Conditions. Your Bid submission through the Bidding System confirms that you have checked and confirmed your pricing and by submitting the Bid online, you agree that you have not omitted any items from your Bid.

- xvi. For construction projects with Bids above \$200,000 the Successful Bidder will be required to execute a “Canadian Standard Form of Construction Contract to a Stipulated Sum” (CCDC 2 - 2020 including amendments thereto as set out in this Procurement.

## **11. Bid Prices**

- i. The amounts stipulated on the Schedule of Prices are intended to cover the cost of the complete Work as described in this Bid Solicitation Document.
- ii. All prices shall be in Canadian Funds, Free On Board (FOB) Destination, Freight Prepaid (Board locations).
- iii. HST is extra and shall not be included in Bid prices.
- iv. The person submitting the Bid on behalf of the Bidder must have authority to bind the Bidder.
- v. Quantities may be estimated, and therefore the Board, at its discretion, may purchase more or less of the commodity based on the unit price bid.
- vi. All information required on the forms shall be completed in full including references and subcontractors that it proposes to use for Work described. Changes made to the list of nominated subcontractors after the closing of the Bid, must have prior written approval of the Board’s Single Point of Contact.
- vii. All price(s) submitted shall be a reasonable price for each particular item as determined by the Board and under no condition will an unbalanced Bid be considered. Submissions containing prices which appear to be so unbalanced as to likely affect the interests of the Board adversely will be clarified and may be rejected.
- viii. Unit prices and/or provisional/supplementary pricing, if any will set the foundation for any approved increases or decreases in Work. The unit prices must remain fixed and firm for the term of the Contract, unless otherwise specified in this Bid Solicitation document.
- ix. Provisional or Supplementary Pricing may or may not be required for completion of the Work called for under the Contract. The Board will decide necessity of these items and quantities thereon based on the unit prices(s) included in their Bid. If Provisional or Supplementary items are not purchased, or quantities are less than estimated, no adjustment or compensation will be awarded to the Bidder by the Board. Provisional or Supplementary pricing is not used for comparison of Bids for award purpose.

## **12. References – Not Applicable**

Bidders must provide a minimum of three (3) references for work of comparable size and scope that has been successfully completed within the last five (5) years. One (1) reference must be from the WRDSB, if you’ve done previous work, otherwise one (1) reference must be of a government entity of similar size, scope, and complexity.

---

References must contain information about your clients including a complete organization name, contact person's names, title, telephone number and/or email address, details of the work provided, start and end dates of the work, and total cost of the work. Bidders cannot use references that pertain to another Vendor/Contractors' work.

The Board reserves the right to contact the clients noted to verify information provided and assess overall client experience. Bidders should ensure that their references are prepared to provide a response if contacted by the Board. If the Board is unable to obtain a satisfactory reference, or if the reference does not respond to the reference call (after Board's best efforts), or if the reference chooses not to comment, the reference will be deemed unsatisfactory, and the Board may ask the Bidder for additional references. Unsatisfactory references may result in the Bidder's submission being rejected.

### **13. Addenda**

All Addenda issued through the Bidding System shall form part of the Bid Solicitation Document.

The Board shall not be bound by any verbal instruction or information provided by any Board employee or consultant of the Board. Only responses provided in an Addendum shall form part of this Bid Solicitation Document.

Prior to bid closing any discrepancies, omissions, questions, or clarifications regarding the procurement documents must be sent immediately through the Bidding System by clicking on the "Submit a Question" button found within the bid details page of that opportunity. no later than the deadline noted in the Anticipated Project Schedule. Those that are deemed pertinent to the Bid Solicitation Document will be addressed in the form of an Addendum.

It is understood and acknowledged that while the Bid Solicitation document includes specific requirements, a complete review and recommendation is required. Minor items or details not herein specified, but obviously required for the Work shall be provided as if specified in conformance with modern practices. Any omissions or errors or misrepresentation of these requirements and specifications within the Bid Solicitation document shall not relieve the Bidder of the responsibility of providing the services or products as aforesaid

Bidders shall acknowledge the receipt of all Addenda in the Bidding System prior to the submission of a Bid. Where Addenda has been issued, the system will not allow the Bidder to submit a Bid prior to acknowledging said Addenda.

Where an Addendum is issued after a Bid has been submitted, the Bidding System will automatically withdraw the submitted Bid. The Bid status will change to incomplete and will not be accepted by the Board as a submitted Bid. It is the responsibility of the Bidder to make any required adjustments to their submission, acknowledge all Addenda and ensure the Bid has been received by the Bidding System. Bidders should check the Bidding System for Addenda up until the Bid Closing Date and Time.

---

Addenda cannot be acknowledged after the Closing Date and Time.

**14. Edit and Withdrawal of Bid Submission**

- i. A Bidder who has submitted a bid may edit or withdraw its bid at any point up to the Closing Date and Time.
- ii. Any edits to a bid submission will cause the submission to automatically be withdrawn. The bid submission must be re-submitted to be accepted.
- iii. The Bidder is solely responsible for ensuring that its re-submission is received prior to Closing Date and Time. The closing time shall be determined by the web clock within the Bidding System. After such time, requests to withdraw Bid will not be considered.

**15. Irrevocable Period**

Bids will be irrevocable by the Bidder, and open for acceptance by the Board, for **60 (sixty) days** following the Closing Date.

**16. Tie Bids**

Where two (2) or more Bids have been received reflecting the same, lowest Bid price, the time stamp for date and time submission in the Bidding System will dictate the award (earliest submission shall prevail).

**17. Bid Irregularities**

Bids with one or more of the following may be declared informal and/or disqualified and/or non-compliant:

- i. Bids that do not comply strictly with all terms and conditions of the Bid Solicitation Document.
- ii. Bids that are incomplete, conditional, qualified, or obscure.
- iii. Bids that are based upon an unreasonable period of time for completion of the Work.
- iv. Bids received from Bidders involved in Claims with either of the Board or banned or on probation with the Board.
- v. Bids received from any Bidder deemed to be unskilled or experienced in the work contemplated, or those who have defaulted on, or failed to satisfactorily complete other similar work in the past.
- vi. Bids submitted by Bidders that are not prequalified, where applicable.

**18. Bid Review**

- i. All Bids received on or before the Closing Time will be reviewed for compliance based on this Bid Solicitation document. Non-compliant Bids will be rejected. Bids not meeting any of the mandatory requirements included in this Bid Solicitation document will be disqualified. Bidders may be contacted to clarify their submissions.

- 
- ii. Should there be any error in extensions, additions or computations, the Board shall be entitled to correct such errors based upon the unit prices supplied, and the corrected total shall be considered as representing the intention of the Bidder and shall be used as the basis for comparison of Bids.
  - iii. It is the Bidder's responsibility to satisfy the Board that they can comply with the requirements contained within this Bid Solicitation document and that they possess the necessary inventory, equipment, facilities, resources, and staff to perform the work specified in this Bid Solicitation document. Bidders may be required to submit evidence of above in a form acceptable to the Board. Substitution of materials, equipment, or methods different from that outlined in the terms of reference will not be accepted unless provided for within this Bid Solicitation document or with the written approval of the Board.
  - iv. The Board also reserves the right to examine Bidder's facilities, equipment and visit the subcontractors or sub-consultants proposed and/or Bidder's existing and past clients. The award decision may be revised based on the above.
  - v. The Board will not be responsible for travel costs if travel is required. No additional charges will be accepted by the Board for any cost incurred by the Bidder or any other party in participating in the Bid evaluations.
  - vi. The Board may, in its sole discretion, check references, conduct credit checks, review the litigation history and history of professional liability or other insurance claims, and obtain any other type of information that might aid the Board in its selection. The Board reserves the right to consider all, or any information received from all available sources, whether internally or externally obtained. The Board may disqualify any Bid from further consideration based on results of reference or credit checks or review of litigation or claim history. The foregoing may include the Board's own experiences with the respective Bidder(s) or any of the subcontractors and sub-consultants proposed in their Bid.

**19. Post-Award Meeting**

A post-award meeting may be held consisting of the successful Vendor/Contractor, and their key personnel assigned to the contract, the Board's Project Manager/Lead and if applicable the Architect/Consultant, to discuss the program and exchange information before the contract commences. This meeting will be at the sole expense of the Bidder and shall be considered part of the contract. If applicable, the meeting date will be scheduled after the Award.

**20. Intent to Award**

Bidders are advised to not make any business decisions, assignment or any sub-contract for the execution of the Work, before receiving a Purchase Order form the Board.

- i. Subject to the reserved rights of the Board and availability of funds, the lowest compliant Bid will be recommended for award.

- 
- ii. There shall be no obligation on the Board as a result of seeking Bids or conducting the procurement process and the Board reserves the right to pursue other Bidders, cancel the Bid Solicitation, issue a revised request, or to pursue any other course of action which would aid in meeting their needs.
  - iii. If Applicable, within **twenty-four (24) “workday” hours** of receiving a request or intent to award from the Board, the Bidder (the “Recommended Bidder”) shall provide a list of all Subcontractors/Subconsultants that it proposes to use for all Work described in this Procurement including the Company Name, Sub Trade Category and if applicable, related Divisions.
  - iv. Within **seven (7) calendar days** of receiving a request or intent to award from the Board, the Bidder (the “Recommended Bidder”) shall provide the following mandatory requirements:
    - a. Insurance certificate with coverage specified in the Bid Solicitation Document.
    - b. WSIB clearance certificate valid on date of award or an exemption letter (if applicable and requested).
    - c. Non-Disclosure Agreement (NDA) duly signed by the authorized signatory (to be renewed annually). The Board will provide this form.
    - d. Bonding Requirements, if applicable, as specified in the Bid Solicitation Document.
    - e. An executed Board issued Form of Agreement, if applicable, and duly signed by the authorized signatory.
    - f. Any other submittal specified in the Bid Solicitation Document or in the intent to award, as a requirement of award.
    - g. For construction projects above \$200,000 the Successful Bidder will be required to execute a “Canadian Standard Form of Construction Contract to a Stipulated Sum” (CCDC 2 – 2020) including amendments thereto as set out in this Procurement.
  - v. The documents listed below will be incorporated as deemed necessary by the Board, into the Contract with the Bidder. If there is a discrepancy between the wording of one document and the wording of any other document that appears on the list, the wording of the document that first appears on the list shall take precedence:
    - a. Board approved change order(s) or Contract/ Agreement/ CCDC 2 -2020 amendment(s)
    - b. Purchase Order(s), Contract(s) Agreement(s)/ CCDC 2 -2020 executed with the Bidder including exhibits
    - c. Bid Solicitation document issued by the Board, including addenda, if applicable



d. Bid submitted by the Bidder

**21. Post Award**

Ministry of Labour Notice of Project confirmation notice to be uploaded in Bids and Tender prior to mobilization and/or prior to first project draw

In addition to all of the Board's other remedies, if a recommended Bidder fails to satisfy the requirements and/or execute the Form of Agreement or any other applicable conditions within seven (7) calendar days of notice of selection, the Board may, in their sole and absolute discretion and without incurring any liability, rescind the selection of that Bidder.

The Bidder may protest within the five (5) day Notice of Intent to Award, after that, the protest will not be reviewed or accepted.

**22. Award Notification**

For procurements valued at \$100,000 or more, and in accordance with the Broader Public Sector Procurement Directive, once the Board is satisfied that all requirements are met, the project award notification will be posted in the same manner as the procurement documents were posted. The notification will be posted after the purchase order and/or agreement between the successful bidder and the Board has been issued/executed. The award notification will list the name of the successful bidder, agreement start and end dates, and any extension options.

**END OF SECTION**

## 00 21 14 – General Contractors and Subcontractors

### 1.0 General Contractor Roster List

- 1.1 Only invited prequalified General Contractors, as a result of the award of a competitive prequalification process, #23-7430-RFPQ, may submit a bid for this opportunity. Invitations are based on awarded Project Size Categories. Roster approved GCs can only bid on the projects size categories based on the award.

### 2.0 Subcontractors/Subconsultants

- 2.1. Refer to specification sections for products, suppliers and installers that will be required.
- 2.2. The Subcontractor/Subconsultant list is not required at time of bid submission.
- 2.3. The Subcontractor/Subconsultant list is mandatory after the bid closing date from the Recommended Bidder **within twenty-four (24) hours** of receiving a request or intent to award from the Board.
- 2.4. The Bidder (the “Recommended Bidder”) shall provide a listing in a Board approved formatted list of Subcontractor/Subconsultant that it proposes to use for all Work described in this Procurement including the specification sections, as per the following:
  - 2.5.1 Bidders shall select experienced and qualified Subcontractor/Subconsultant or Suppliers in their field to perform or supply an item of Work indicated in this Procurement.
  - 2.5.2 The Bidder shall be fully aware of the capability of each Subcontractor/Subconsultant and/or Supplier included in its bid, including but not limited to technical ability, financial stability and ability to maintain the proposed construction schedule.
  - 2.5.3 The Owner reserves the right to reject any nominated Subcontractor/Subconsultant or supplier, based on the following but not limited to unsatisfactory past performance, suspended/removed from doing business with the Board and/or outstanding/unresolved corrective action notice issued by the Owner to the Subcontractor/Subconsultant within the last three (3) years.
  - 2.5.4 The Owner reserves the right to obtain information from the Bidder and from third parties respecting the qualifications and experience of the Bidder’s nominated list of Subcontractor/Subconsultant for such item of the Work.
  - 2.5.5 The Board reserves the right to examine Bidder’s facilities, equipment and visit the Subcontractor/Subconsultant’s proposed.

**24-7556-RFT**

---

- 2.5.6 The substitution of any Subcontractor/Subconsultant and/or Suppliers after the list is submitted will not be accepted unless a valid reason is given in writing to and approved by the Owner, whose approval may be arbitrarily withheld.
- 2.5.7 Where a bidder lists “own forces” in place of a Subcontractor/Subconsultant, the bidder shall carry out such item of the Work with its own forces.
- 2.5.8 Where “own forces” have been listed by a bidder, the Owner reserves the right to obtain information from the bidder and from third parties respecting the qualifications and experience of the bidder’s “own forces” for such item of the Work.

**END OF SECTION**

### **00 21 15 – Scope of Work**

The scope of work for the Family Studies Renovation & HVAC Upgrades project at Waterloo-Oxford District Secondary School includes, but is not limited to the following:

1. Complete renovation of Family Studies Rooms 530/ 530A/ 531.
2. Complete HVAC Upgrade to Rooms 509 (and ancillary rooms), 511 (and ancillary rooms), 512, 513 (and ancillary rooms), 514, 515, 516 (and ancillary rooms), 517, 534 and 536.  
Work includes:
  - Removal of existing ceilings, lighting and mechanical systems
  - Fireproofing of steel structure
  - New lighting and devices
  - New ceiling finishes
3. Replacement of ceilings, lighting fixtures, diffusers in Corridors 813 and 824. Above ceiling work includes structural reinforcement for new HVAC rooftop equipment.
4. Electrical system upgrades.

Refer to Drawings and Specifications for full Scope of Work.

**END OF SECTION**

**00 31 34 – Subsurface Investigation Report**

.1 NOT APPLICABLE.

**END OF SECTION**

**Appendix 00 31 34A – Soil Report**

.1 NOT APPLICABLE.



**00 41 73 – Supplementary Bid Information**

**a) General Contractor**

A Site Supervisor and Project Manager, assigned to manage and supervise the Work, must be named in the Bidder's Contact Information Specification section through the electronic Bidding System only and include resumes. Personnel will be subject to approval by the Board and cannot be changed without prior written approval from the Board.

**b) Identified Price Form**

NOT APPLICABLE.

**END OF SECTION**



## **00 56 13 – Definitions Stipulated Price**

### **1.1. Definitions Declaration**

- .1 CCDC 2-2020 Edition, Stipulated Price Contract as may be amended, forms the basis of Definitions between the Owner and Contractor.
- .2 These Definitions are bound to the CCDC 2 Definitions and CCDC 2 General Conditions.

### **1.2. Supplementary Words and Terms to CCDC 2-2020**

- .1 The following words and terms are additional to the CCDC 2 Definitions.
- .2 Addendum: A document that amends the Bid Documents during the Bidding Period and becomes part of the Contract Documents when a Contract is executed. (Plural: Addenda).
- .3 Agreement: The signed and sealed legal instrument binding parties in a Contract, describing in strict terms their mutual arrangement, roles and responsibilities, commencement, and completion responsibilities.
- .4 Alternative Price: The amount stipulated by a Bidder for an Alternative and stated as an addition, a deduction, or no change to the Bid Price.
- .5 Authorities: Those having jurisdiction under law over Work or Parts thereof.
- .6 Bid: To offer as a Bid stating for what price a Contractor will assume a Contract.
- .7 Bid Documents: A set of documents consisting of the Instructions to Bidders, Bid Form, Contract Documents, and other information issued for the benefit of Bidders to prepare and submit a Bid.
- .8 Bid Form: The specific and detailed form used to collect information about a Bid.
- .9 Bidding: The process of preparing and submitting a Bid.
- .10 Construction Documents: The Drawings and Project Manual. When combined with a Contract and Contract conditions, these documents form the Contract Documents.
- .11 Contingency Allowance: An additional monetary amount added to a Project cost estimate and designated to cover unpredictable or unforeseen items of Work. The amount is usually based on some percentage of the estimated cost and expended and adjusted by Change Order. It is not intended to cover additions to the scope of Work.
- .12 General Conditions: That part of the Contract Documents which sets forth many of the rights, responsibilities and relationships of the parties involved in a Contract.
- .13 Exposed: Visible at completion of Work, in usable areas as well as interior of closets, cabinets, drawers, storage and service rooms, stairwells and exterior surfaces.

- 
- .14 Instructions To Bidders: Instructions contained in the Bid Documents to convey an Owner's expectations and criteria associated with submitting a Bid.
  - .15 Ready for Takeover: *Ready-for-Takeover* shall have been attained when the conditions set out in GC12.1, SC 55.1 , 12.1.1
  - .16 Section: A portion of a Project Specification covering one or more segments of the total Work or requirements. Sections are included in a Project manual as required to meet Project requirements.
  - .17 Standard: A document describing a grade or a level of quality, which has been established by a recognized agency or organization, utilizing an internal voting process.
  - .18 Separate Price: A separate price for work to be added to the base price if selected by the Owner. This price type is not a part of the base bid price.
  - .19 Stipulated Price: An amount set forth in a Stipulated Price Contract as the total payment for the performance of the Work. Sometimes referred to as a stipulated sum or a lump sum stipulated price.
  - .20 Tender: Refer to definition of Bid.
  - .21 Unit Price: The amount payable for a single unit of Work as stated in a Schedule of Prices.
  - .22 Install: To remove from site storage, move or transport to intended location, install in position, connect to utilities, repair site caused damage, and make ready for use.
  - .23 Supply: To acquire or purchase, ship or transport to the site, unload, remove packaging to permit inspection for damage, re-package, replace damaged items, and safely store on-site.
  - .24 Provide: To Supply and Install
  - .25 Wherever words 'approved', 'selected', 'satisfactory', 'directed', 'permitted', 'inspected', 'instructed', 'required', 'submit', 'ordered', 'reviewed', 'reported to', or similar words or phrases are used in Contract Documents, it shall be understood, unless context provides otherwise, that words 'by Consultant' or 'to Consultants' follow.
  - .26 Words 'by others' when used in Specifications or on Drawings shall not mean by someone other than Contractor. Only means by which something shown or specified shall be indicated as not being in Contract is by initials 'NIC' or words 'not in Contract', 'by Owner', or 'by Other Contractor'.

**END OF SECTION**

## **00 72 13 – Standard Terms and Conditions**

### **1. Applicable Terms and Conditions**

None of the standard or other terms, conditions, or policies of the Bidder, whether published or otherwise shall be of any effect unless accepted by the Board in writing. This includes, without limitations, terms in publications, web-site, sales invoice, delivery document as well as those commonly applied by the Bidder. Board's acceptance of goods, equipment or service, acknowledgement thereon or paying invoices shall not imply acceptance of such terms, conditions, or provisions.

### **2. Bankruptcy**

If, during the term of the Contract, the Vendor/Contractor makes an assignment for the benefit of creditors, or becomes bankrupt or insolvent, or makes a proposal to its creditors, the Contract with the Vendor/Contractor shall immediately be terminated, and the Board shall be entitled to enter into an agreement with another party without the consent of the Vendor/Contractor.

### **3. Basis of Award (Price factor)**

Bidders shall be deemed to have included all costs related to the Work in the Total Price as provided in their Bid, except for items clearly identified as provisional in the Bid Solicitation document. In no case shall the invoicing for the entire Work performed exceed the Total Price, unless additional Work is ordered by the Board in writing. The unit prices as well as provisional pricing shall be used to invoice the additional or provisional work, as required by the Board. For the purpose of award, the Total Price will be considered as representing the intention of the Bidders and will be used as the basis for comparison of Bids for the price factor.

### **4. Bonding Requirements**

Bonding is required if the project is equal to or greater than \$200,000.00.

Note: The Bidding System has flagged these fields as mandatory. If your bid is less than \$200,000.00, you may upload a pdf document stating: Not Applicable.

#### **i. Bid Amount**

Bonding requirements are based on the total base bid amount INCLUSIVE of ALL applicable taxes.

#### **ii. Bid Deposit Bond & Agreement to Bond**

Bid submissions must be accompanied by a bid deposit in the form of a digital Bid Bond in an electronically verifiable and enforceable (e-Bond) format in the amount of 10% of the total base bid (inclusive of HST) made payable to the Waterloo Region District School Board (the 'Board') as surety that, if the Bid is accepted, a Contract will be entered into for the proper performance of the work. For more information, contact your surety company or visit the Surety Association of Canada website.

Bid Submissions must be accompanied by an Agreement to Bond in the form of a digital Bond in an electronically verifiable and enforceable (e-Bond), completed and executed by the Bidder's Surety, assuring the successful Vendor/Contractor shall provide for a Performance Bond for 50% of the total Contract Price, and a Labour and Material Payment Bond for 50% of the total Contract Price.

Bidders shall upload their digital Bid Deposit Bond and Agreement to Bond separately to the Bidding System, in the bid submission files labeled "Bid Deposit Bond" & "Agreement to Bond". If both Bonds are within one (1) document, upload it in both files. All instructions and details for accessing authentication shall be included with the digital Bonds uploaded in the Bidding System. Do not include and/or upload Performance Bond and Labour and Materials Bond in this section.

Bids that do not contain the bid deposit(s) in the required amount will be declared non-compliant and will be rejected. A scanned PDF copy of bonds or original certified cheque, bank draft, money order, etc. are not acceptable as Bid deposit and will result in your Bid being rejected.

The bid deposit of the Bidder whose submission is accepted shall be forfeited by the Bidder should the Bidder fail to execute a Contract or provide the necessary documents as required within this Bid Solicitation document (including but not necessarily limited to: signed agreement, satisfactory security, insurance certificate, appropriate Workplace Safety and Insurance Board letter of clearance certificate) within the time stipulated as a written notice from the Board.

For bid amounts where Bonding is not requested, the Awarded Bidder agrees to pay to the Board the difference in costs between the bid submitted and the final contract should the Awarded Bidder fail to either execute or deliver the contract documents in accordance with the Bid Solicitation within seven (7) calendar days of written notification of the award of the contract.

**iii. Performance and Labour & Materials Bonds**

For bid amounts where bonding is required, inclusive of all taxes, the successful Bidder shall provide a digital Bid Performance and Labour and Materials Bond in an electronically verifiable and enforceable (e-Bond) format in the amount(s) of not less than 50% Performance Bond and a 50% Labour and Materials Bond of the total Contract Price made payable to the Waterloo Region District School Board (the 'Board') as surety that, if the Bid is accepted, a Contract will be entered into for the proper performance of the work and extends protection to Subcontractors, Suppliers, and any other persons supplying labour or materials to the Project. For more information, contact your surety company or visit the Surety Association of Canada website.

If the successful Bidder fails to provide a performance bond and/or labour and materials bond when requested, the Board may declare the bid deposit forfeited and the Bidder will be held responsible for any increased costs or damages incurred by the Board. Any Bidder who fails to provide all required documents within the timelines provided, or otherwise fails to enter into an agreement with the Board upon notice of being the successful Bidder may be subject to future bidding constraints by the Board.

Performance bond shall guarantee all conditions as set out in the contract, including proper execution of the work and for all matters for which the successful Bidder is responsible for throughout the two (2) year period of maintenance and warranty.

Any costs associated with performance bond are the responsibility and cost of the Bidder.

Bonds must be submitted through the Bidding System within seven (7) calendar days of receiving the Intent to Award.

**5. Business Code of Conduct for Board Employees**

The Board will not knowingly purchase goods and/or services from Vendor/Contractors who operate in contravention of local and international laws. If a product and/or service supplied to the Board is discovered to be in contravention, the Board reserves the right to rectify the issue with the Vendor/Contractor, including the cancellation of the contract.

The Board expects that all employees and Vendor/Contractors act within the parameters of the [Administrative Procedure 4360 Principles of Business Conduct for Board Employees](#)

**6. Code of Conduct for Vendors/Contractors**

These Guidelines cover any vendor, contractor, supplier, business, firm, company or individual doing work, providing a service or delivering goods on any Waterloo Region District School Board property, as well as the contractor's employees, sub-contractors, agents, consultants, and others on site in connection with the contractor's work or at the vendor/contractor's express or implied invitation.

- i. **Courtesy and Respect:** all vendor/contractors and their employees must conduct themselves in a manner that is lawful, courteous, businesslike, and respectful of all students, staff, faculty, guests, or visitors.
- ii. **Language and Behavior:** vendors/contractors and their employees cannot engage in behavior that is rude, threatening, or offensive. Use of profane or insulting language is prohibited. Harassment of any type, including sexual harassment is strictly prohibited. Abusive, derogatory, obscene or improper language, gestures, remarks, whistling, cat calls or other disrespectful behavior

- cannot be tolerated. Rough housing, fighting, fisticuffs, physical threats, destruction of property, vandalism, littering, or physical abuse of anyone on WRDSB property are not permitted under any circumstance.
- iii. **No Weapons, Alcohol, or Drugs:** The use, possession, distribution, or sale of any weapon, alcohol, illegal drug, or controlled dangerous substance by any contractor or contractor's employee is prohibited. Offenders will be removed from WRDSB property and/or reported to the local Police Department.
  - iv. **Smoking:** Contractors and their employees are not permitted to smoke on WRDSB property, in or near any buildings.
  - v. **Fraternization:** Vendor/Contractors and their employees may not fraternize or socialize with WRDSB students or employees.
  - vi. **Appearance:** Vendor/Contractors and their employees are required to wear appropriate work wear, hard hats and safety footwear, as the case may be, while on WRDSB property. Articles of clothing must be neat and tidy in appearance, and cannot display offensive or inappropriate language, symbols or graphics. WRDSB has the right to decide if such clothing is inappropriate.
  - vii. **Reporting:** The Vendor/Contractor is required to report any matter involving a violation of these rules of conduct, any matter involving health or safety, including any altercations, to WRDSB Facilities staff.

The Vendor/Contractor is responsible for its employees, agents, consultants and guests. If prohibited conduct does occur, the vendor/contractor will take all necessary steps to stop and prevent any future occurrence. Any breach of these conditions will result in the removal of the person responsible from the school premises and prohibited actions could result in the termination of any contract or agreement with WRDSB.

## **7. Compliance with Laws, Acts and Regulations**

Vendor/Contractors shall abide by all applicable provincial and federal laws, as well as Board Policies. Some of the applicable laws are highlighted below for information purposes only. In case of any discrepancy between this Bid Solicitation Document and the provision of applicable laws, the latter shall prevail. This list is not intended to be a comprehensive summary of relevant laws or be a complete list of applicable regulations or interpretation of the provisions of any laws

- i. Broader Public Sector Accountability Act, 2010
- ii. Construction Act
- iii. Architect Act
- iv. Canada Revenue Agency (CRA) regulations
- v. Accessibility for Ontarians with Disabilities Act (AODA)
- vi. Workplace Safety and Insurance Act (WSIB)
- vii. Occupational Health and Safety Act

- viii. Trade Agreements (CETA/CFTA)
- ix. Education Act
- x. [Fighting Against Forced Labour and Child Labour in Supply Chains Act](#)
- xi. [WRDBS Procurement Services Policies website](#)
- xii. [WRDSB Policies and Procedures](#)

Non-compliance to provincial and/or federal laws, or Board Policies may result in rejection of the Bidder's Bid submission and/or termination of Contract.

Bidders shall make themselves aware of provisions in all applicable provincial and federal laws as well as Board policies and ensure full compliance. Non-compliance may result in rejection of Bid and/or termination of Contract.

The successful Bidder(s) will be required to comply with all applicable federal, provincial laws as well as Board policies in performing its obligations under the Contract including, without limitation, the Occupational Health and Safety Act, as amended, and the Workplace Safety and Insurance Act, 1997, as amended, and Accessibility for Ontarians With Disabilities Act, 2005, S.O. 2005, c.11, Accessibility Standards for Customer Services O. Reg. 429/07 requirements, under the Accessibility for Ontarians With Disabilities Act, 2005, as amended, or any successor legislation applicable, and to provide to the Board, upon request, periodic reports and evidences confirming such compliance.

By supplying the goods or equipment and/or providing services, the Vendor warrants that the goods or equipment supplied, and services provided to the Board conforms in all respects to the standards and codes set forth by federal and provincial agencies. Failure to comply with this condition will be considered a breach of this Contract.

The obligations of the parties and resolutions of any disputes shall be governed by and construed in accordance with the laws of the Province of Ontario and the federal laws of Canada, including the Construction Act, as to interpretation and performance, and shall be treated, in all respects, as an Ontario contract. The parties shall attorn to the exclusive jurisdiction of the courts of the Province of Ontario.

## **8. Confidential Information and Municipal Freedom of Information and Protection of Privacy Act**

All information and documentation provided by the Board or to the Board in connection with this Procurement, before or after the issuance of this Procurement is the sole property of the Board and shall be treated as confidential, subject to the provisions of the Municipal Freedom of Information and Protection of Privacy Act (MFIPPA).

Bidders shall identify any confidential information in their Bid Submission. The Board will make reasonable efforts to safeguard confidential information, subject to its disclosure requirements under MFIPPA or any other disclosure requirements imposed by law or by order of a court or competent tribunal. Bidders are advised that their Bid submissions

may be disclosed, on a confidential basis, to advisers retained by the Board to advise or assist with the Bid process, including the evaluation of Bid submissions.

Bidders should be advised that when submitting a Bid, the name, title, and contact information will be made public upon request. Under MFIPPA, and as a record of the Board, the Bid prices submitted and agreed to under contract with the Board can also be made available through a Freedom of Information request. Bidders will be notified regarding requests for any other information submitted in a Bid; information may be disclosed to a requester in whole or part unless otherwise considered exempt from disclosure under MFIPPA.

**9. Confirmation to Proceed**

No work shall commence until the Board has issued a purchase order and/or contract, if applicable to the successful Bidder. Goods/Service or Work as described shall not commence until all the required documents have been submitted to Procurement Services and the Form of Agreement and/or the CCDC 2 - 2020 if applicable, are executed by the Successful Bidder and the Board. For payment purposes, a Purchase Order shall be generated and issued to the Successful Bidder. The Purchase Order number must appear on all invoices in order to ensure prompt payment.

**10. Conflict of Interest**

By submitting a Bid, the Bidder confirms that they have no conflict of interest with respect to other work and/or other clients. The Bidder shall ensure that all subcontractors, sub-consultants and suppliers also have no conflict with respect to other work and/or other clients.

The Vendor/Contractor, Subcontractors and Suppliers and any of their respective advisors, partners, directors, officers, employees, agents, and volunteers shall not engage in any activity or provide any services where such activity or the provision of such services creates a conflict of interest (actually or potentially, in the sole opinion of the Owner) with the provision of the Work pursuant to the Contract. The Vendor/Contractor acknowledges and agrees that a conflict of interest, as described in this section includes, but is not limited to, the use of Confidential Information where the Owner has not specifically authorized such use.

The Vendor/Contractor shall disclose to the Owner, in writing, without delay, any actual or potential situation that may be reasonably interpreted as either a conflict of interest or a potential conflict of interest, including the retention of any Subcontractor or Supplier that is directly or indirectly affiliated with or related to the Vendor/Contractor.

The Vendor/Contractor covenants and agrees that it will not hire or retain the services of any employee or previous employee of the Owner where to do so constitutes a breach by such employee or previous employee of the Owner's conflict of interest policy, as it may



be amended from time to time, until after completion of the Work/Services under the Contract.

It is of the essence of the Contract that the Owner shall not have direct or indirect liability to any Subcontractor or Supplier, and that the Owner relies on the maintenance of an arm's-length relationship between the Vendor/Contractor and its Subcontractors and Suppliers. Consistent with this fundamental term of the Contract, the Vendor/Contractor will not enter into any agreement or understanding with any Subcontractor or Supplier, whether as part of any contract or any written or oral collateral agreement, pursuant to which the parties thereto agree to cooperate in the presentation of a claim for payment against the Owner, directly or through the Vendor/Contractor, where such claim is, in whole or in part, in respect of a disputed claim by the Subcontractor or Supplier against the Vendor/Contractor, where the payment to the Subcontractor or Supplier by the Vendor/Contractor is agreed to be conditional or contingent on the ability to recover those amounts or a portion thereof from the Owner, failing which the Vendor/Contractor shall be saved harmless from all or a portion of those claims. The Vendor/Contractor acknowledges that any such agreement would undermine the required arm's-length relationship and constitute a conflict of interest. For greater certainty, the Vendor/Contractor shall only be entitled to advance claims against the Owner for amounts pertaining to Subcontractor or Supplier claims where the Vendor/Contractor has actually paid or unconditionally acknowledged liability for those claims or where those claims are the subject of litigation or binding arbitration between the Subcontractor or Supplier and the Vendor/Contractor has been found liable for those claims.

A breach by the Vendor/Contractor, any of the Subcontractors, Suppliers or any of their respective advisors, partners, directors, officers, employees, agents, and volunteers shall entitle the Owner to terminate the Contract, in addition to any other rights and remedies that the Owner has in the Contract, in law, or in equity.”

**11. Construction Act Guidelines**

For Work that is governed by the provisions of the Construction Act, the Construction Act shall apply where applicable including in respect to release of 10% holdback, 2% deficiency holdback, adjudication, and the provision of security.

**12. Criminal Background Checks and Collection of Personal Information**

The Board must comply with Ontario Regulation 521/01 (Collection of Personal Information) of the Education Act with respect to criminal background checks and offence declarations.

If required by the Board, the Vendor/Contractor will provide to the Board, or designate, a Criminal Background check for pertinent individuals covering offences under the Criminal Code, the Controlled Drugs and Substances Act, and any other offences which would be revealed by a search of the automated Criminal Records Retrieval System.

---

An Offence Declaration on a Board-approved form for every employee of the Vendor/Contractor who may come in direct contact with Board staff and/or students on a regular basis at any Board site prior to the occurrence and on or before September 1 each year thereafter may be required. Updated Offence Declarations may be required annually. The Board will determine in its sole discretion whether this is a requirement.

Termination of contracts may be the result of non-compliance to this requirement.

**13. Damage Responsibility of Contractor/Vendor**

The Vendor/Contractor, their agents and all workers and persons employed by them or under their control, shall use due care that no person or property is injured and that no rights are infringed in the prosecution of the work, and the Vendor/Contractor shall be solely responsible for all damages by whomsoever claimable in respect of any injury to persons or to lands, buildings, structures, utilities, survey markers, fences, livestock, trees, crops, roads, ways, ditches, drains and in watercourses, whether natural or artificial, or property or whatever description and in respect of any infringement of any right, privilege or easement whatever occasioned in the carrying on of the work or any part thereof, or by any neglect, misfeasance or nonfeasance on the Vendor/Contractor's part or on the part of any of his agents, workers and persons employed by them or under their control shall bear the full cost thereof and shall at his own expense make such temporary provisions as may be necessary to ensure the avoidance of any such damage, injury or infringement.

The Vendor/Contractor shall indemnify and save harmless the Board from and against all claims, demands, loss, costs, damages, actions suits or other proceedings by whomsoever made, brought, or prosecuted in any manner based upon, occasioned by, or attributed to any such damage, injury, or infringement.

Notwithstanding the indemnity provisions contained in this section, where in the opinion of the Board Representative the Vendor/Contractor has failed to rectify any damage, injury or infringement or has failed to adequately compensate any person for any damage, injury or infringement for which the Vendor/Contractor is responsible under the Contract, the Board, following notice in writing to the Vendor/Contractor of his intention so to do, may withhold payment of any monies due to the Vendor/Contractor under this or any other Contract until the Vendor/Contractor has rectified such damage, injury or infringement or has paid adequate compensation for such damage, injury or infringement.

**14. Damage Reporting**

If a utility structure or device, utility cable/conduit, or utility related infrastructure is damaged, the Vendor/Contractor shall notify the Board representative the same working day of any service disruption or damage and the Vendor/Contractor will immediately notify the utility company to initiate repair. The Vendor/Contractor will additionally make every reasonable effort to advise impacted resident(s) of a service disruption.

It is understood that all damage caused by workers engaged in the work under these specifications will be repaired by the Vendor/Contractor and at the Vendor/Contractor's sole expense. Damaged turf areas will be levelled and seeded, all horticultural planting damaged beyond repair will be replaced and any damage to structures, utilities, signs, light fixtures, landscape furniture, irrigation systems etc. will be repaired or replaced. Repair work will be carried out by skilled workers acceptable to the Board representative. All repairs and replacements will be approved by a Board representative prior to final payment.

**15. Debriefing Requests**

For procurements valued at \$100,000 or more, and in accordance with the Broader Public Sector Procurement Directive, unsuccessful Bidders are entitled to a debriefing to receive feedback with respect to their Bid submission. To obtain a debriefing, Bidders shall contact the Single Point of Contact listed in this Bid Solicitation Document in writing with their request within sixty (60) calendar days of the award notification.

**16. Default**

If the Vendor/Contractor fails to properly, promptly, and fully carry out the Work required by these documents, the Board reserves the right to notify the Vendor/Contractor to discontinue all Work under this Contract, to advertise for new Bids or carry out the Work in any way as the Board may, in their sole discretion, deem best.

The Vendor/Contractor further agrees to indemnify and save harmless the Indemnified Parties from all loss, damage, liability, cost, charge, or expense whatsoever which it, they or any of them may suffer, incur or be put to by reason of such default or failure.

**17. Delay Claims**

The Vendor/Contractor shall be responsible for all deliverables including lead times. The bidder shall include in their bid price any costs associated with an extended schedule beyond the stated substantial completion date due to delayed deliveries of items. Costing is to be inclusive of any afterhours work required due to the school being occupied by staff and students during the school year until completion.

The board will not accept or consider any "delay claim" requests for delayed deliverables outlined in the tender documents.

**18. Designated Substances**

The Occupational Health and Safety Act of Ontario (OHSa) allows for certain toxic substances to be especially designated. The OHSa defines a designated substance as "a biological, chemical, or physical agent or combination thereof prescribed as a designated substance to which the exposure of a worker is prohibited, regulated, restricted, limited, or controlled". Ontario Regulation 490/09 - Designated Substances (O.Reg. 490/09), made under the Occupational Health and Safety Act outlines required steps to control exposure of workers to designated substances. Under O. Reg. 490/09 there are eleven (11)

designated substances: acrylonitrile, arsenic, asbestos, benzene, coke oven emissions, ethylene oxide, isocyanates, lead, mercury, silica and vinyl chloride. This regulation applies to every employer and worker at a workplace where the designated substances are present, produced, processed, used, handled or stored and at which a worker is likely to be exposed to the designated substance.

I. Asbestos

Asbestos-containing material (ACMs) were identified during the completion of the Asbestos Audit Update Report (AAU), prepared by MTE Consultants Inc. Each facility was surveyed, and if applicable, an AAU Report is available, refer to attached, Appendix 01 35 34A. If these materials, including those deemed or suspected, will be disturbed, or will likely be disturbed, during building maintenance, renovations, construction, or demolition activities, they must be handled and disposed of in accordance with the procedures prescribed by O. Reg. 278/05.

Should the Vendor/Contractor encounter asbestos, not noted in the above AAU Report, which would be disturbed during the course of the Work they should stop the work in that immediate area and report the same to the Board Contact.

All asbestos work must be conducted by Vendor/Contractors approved by the Board, who are trained in the type of asbestos operations required and should be overseen by a qualified third-party Health, Safety and Environmental professional. To conduct Type 3 asbestos operations, Vendor/Contractors must be certified as Asbestos Abatement Workers AAW (Trade code 253W) and Asbestos Abatement Supervisors AAS (Trade code 253S) by The Ministry of Training, Colleges and Universities as prescribed by Section 20 of O. Reg. 278/05.

Unless otherwise specifically covered by Cash Allowance or Contingency Allowance for known asbestos materials, include in this contract for the removal under abatement, in compliance with O. Reg. 278/05, of all known asbestos containing materials, as identified in the audit, within 0.6 meter (2'-0") of all new services, materials, and equipment, and/or as required to complete the work. No claims for extra cost will be accepted for areas known to contain asbestos containing materials.

II. Lead

Lead was historically used in mortar pigments, ceramic glazing; plumbing solder, electrical equipment and electronics solder, in pipe gaskets as packing in cast iron bell and spigot joints of sanitary drains, flexible plumbing connections, flashing panels, acoustical dampeners, phone cable casing and some architectural applications. The assessment of lead for this assignment was limited to paint on interior and exterior surfaces which may be disturbed during the Work.

Preliminary paint, coatings or materials were collected within the work area to determine if lead-containing paints, including lead-based paints, are present. The analytical results, if applicable, including the location marked on the floor plans are available, refer to attached, Appendix 01 35 34B.

Should the Vendor/Contractor encounter paint and coatings, not sampled, that would be disturbed during the course of the Work, they should stop the work in that immediate area and report the same to the Board Contact.

Unless otherwise specifically covered by Cash Allowance or Contingency Allowance for known lead-containing paint and coatings, include in this contract for the removal or disturbance of lead-containing materials, must be completed in compliance with "Lead on Construction Projects" guideline (April 2011). No claims for extra cost will be accepted for lead-containing paint or coatings in identified areas.

The classification of typical lead-containing construction tasks is based on presumed airborne concentrations obtained from the U.S. Occupational Safety and Health Administration (OSHA), the Ontario Ministry of Labour, and published research studies. The classification of Type 1, Type 2, or Type 3 operations are grouped based on the following concentrations of airborne lead

Vendor/Contractor shall inform all workers of the presence of paint finishes that are lead containing. Disturbance of lead-containing materials, paints or surface coatings shall be conducted in accordance with the procedures outlined in the Environmental Abatement Council of Canada (EACC) "Lead Guideline" (October 2014) and/or the Ministry of Labour (MOL) "Lead on Construction Projects" guideline (April 2011). The extent of procedures required depends on the type of work to be conducted. Waste to be handled and disposed of in accordance with O.Reg. 347.

III. Mercury

Mercury is typically used in building service applications such as thermometers, barometers, thermostats, gauges, electrical switches, and lighting products including fluorescent light bulbs and a variety of High Intensity Discharge (HID) lamps as mercury vapour, metal halide and high pressure sodium lamps. Lamps and other devices that require demolition are to be handled with care and kept intact to avoid potential exposure. Any mercury-containing lamps or other equipment that are demolished are to be recycled. Waste to be handled and disposed of in accordance with O.Reg. 347.

IV. Silica

Silica is present in rock, stone, soil, and sand. Masonry products such as concrete block, brick, and mortar, as well as concrete and associated products contain silica.

Due to its ubiquitous nature, silica was historically used in a wide variety of building materials and is still used today in new construction.

All work involving the demolition silica-containing materials shall follow the procedures outlined in the MOL “Silica on Construction Projects” guideline. Type 1 operations may be necessary based on the type of work conducted and the Vendor/Contractor shall implement dust suppression methods and protect workers.

V. **Other Designated Substance**

In addition to asbestos and/or lead, silica, and mercury are present in all WRDSB facilities. New construction, renovation or alterations require compliance by the Vendor/Contractor with the applicable legislation. Other designated substances (i.e., acrylonitrile, arsenic, benzene, coke oven emissions, isocyanates, ethyl oxide, and vinyl chloride) are not encountered in WRDSB facilities as significant constituents or in a form that would represent an exposure concern. responsible for obtaining its own independent financial, legal, accounting, and technical advice with respect to any information included in the Bid Solicitation Document or in any data, materials, or documents provided or required by the Board.

**19. Dispute Resolution**

All disputes arising out of or in connection with this Contract, or in respect of any legal relationship associated with or derived from this Contract, other than with respect to the Board’s right to terminate this Contract, shall first be mediated pursuant to the [National Mediation Rules of the ADR Institute of Canada, Inc.](#) Despite this agreement to mediate, the Vendor/Contractor or the Board may apply to a court of competent jurisdiction or other competent authority for interim measures of protection at any time. All disputes remaining unsettled after mediation shall be arbitrated and finally resolved before a single arbitrator pursuant to the National Arbitration Rules of the ADR Institute of Canada, Inc. The place of mediation and arbitration shall be Toronto, Ontario, Canada. The language of the mediation shall be English.

**20. Electrical Safety Requirements**

All electrical equipment and components must bear a C.S.A. or Electrical Safety Association (E.S.A.) label.

**21. Emergency and Maintenance**

The care of the Works until completed, delivered to and accepted by the Board rests solely with the Vendor/Contractor who shall assume all risk of damage to the work.

For the purpose of emergency and maintenance measures, the name, address, and telephone number of a responsible official of the contracting firm shall be given to the Board’s contact person in charge of the project, if requested. This official shall always be available and have the necessary authority to mobilize workers and machinery and to take any action as directed by the Board in the event emergency or maintenance measures are

required, regardless of the fact that the emergency or requirement of maintenance may have been caused by the Vendor/Contractor's negligence, Act of God, or any cause whatsoever.

Should the Vendor/Contractor be unable to carry out the required immediate remedial measures, the Board may carry out the necessary repairs and the costs for this work shall be deducted from payments due to the Vendor/Contractor.

**22. Equivalent or Brand Name**

Any reference to a brand name or a particular manufacturer shall be understood to have been made solely for the purpose of establishing and describing required performance and quality levels of the product to be supplied, unless specified otherwise.

No reference to the brand name of a particular manufacturer shall be construed to restrict Bidders to that manufacturer. Bidders are invited to Bid equivalent and comparable equipment or items of any manufacturer, pending approval from the Board in the form of an Addendum. It is the Bidder's responsibility to demonstrate that the item meets the specifications.

Bidders shall request through the Bidding System by clicking on the "Submit a Question" button found within the bid details page of that Procurement that a proposed product be considered an approved equivalent prior to the Deadline for Questions in the Anticipated Project Schedule.

The request must include enough detail to determine equivalency by comparing the Board's specifications to the alternate product. It will not be the Board's responsibility to perform this comparison.

The Board/ Consultant may, depending on the nature of the product request site visits within a reasonable distance (preferable within 100 km of the Board) showing product and installation based on a certain age, minimum 18 months in use, room use, room size, etc. based on same or similar purpose as described in this Procurement.

The Board/Consultant will endeavor to complete a review and make a decision prior to the Closing Date, and, if required, the Board reserves the right to extend the Closing Date to complete its review. However, in the event additional time is required beyond a suitable extension to the Closing Date, the request will be pending until the product is thoroughly vetted, therefore, it may not be approved for this particular Procurement.

If the Board is willing to consider the product with its differences, it will be communicated in the form of an Addendum prior to the Closing Date.

The cost of any testing requirements to establish acceptable equivalent or comparable products will be borne by the Bidder, unless otherwise stated by the Board.

**23. Evidence of Quality**

It is the Bidder's responsibility to prove their product/service quality meets the Board's requirements and Bidders may be required to submit evidence in a form acceptable to the Board. Substitution of materials equipment or methods different from that outlined in the specifications / terms of reference will not be accepted unless provided for within the Bid Solicitation document or without the written approval of the Board.

**24. Force Majeure**

If either party is delayed in the performance of their obligations under this Contract by Force Majeure, then the Contract Time shall be extended for such reasonable time as the Owner and the Vendor/Contractor shall agree. The extension of time shall not be less than the time lost as a result of the event causing the delay, unless the parties agree to a shorter extension. Neither party shall be entitled to payment for costs incurred by such delays. Upon reaching agreement on the extension of the Contract Time attributable to the Force Majeure event, the Owner and the Vendor/Contractor shall execute a Change Order indicating the length of the extension to the Contract Time and confirming that there are no costs payable by the either party for the extension of Contract Time. However, if at the time an event of Force Majeure arises a party is in default of its obligations under the Contract and has received a notice of default shall not excuse a party from its obligation to cure the default(s). For greater certainty, the defaulting party, to the extent possible, must continue to address and cure the default notwithstanding an event of Force Majeure."

Any cause, unknown at the effective date of the Contract and beyond either party's control, other than financial difficulties, bankruptcy or insolvency, which prevents the performance by a party, or both, of any of their respective obligations under the Contract and the event of Force Majeure did not arise from a party's default and could not be avoided or mitigated by the exercise of reasonable effort or foresight. Force Majeure includes Labour Disputes; fire; unusual delay by common carriers or unavoidable casualties; delays in obtaining third-party licenses, permits, agreements, or approvals (excluding approvals of any Subcontractors or Suppliers of any tier); civil disturbance; emergency acts, orders, legislation, regulations or directives or revoking of funding from any government or other public authority; acts of a public enemy; war; riot; sabotage; blockage; embargo; lightning; earthquake; adverse weather conditions but only if substantially beyond the weather norms of the Place of the Work; acts of God; or declared epidemic or pandemic outbreak or other public health emergency (e.g. SARS, COVID-19)

If in the reasonable opinion of either party to this Contract that performance of the Contract is made impossible by force majeure, then either party shall notify the other in writing and the Board shall either terminate the Contract forthwith without any future payments being made or authorize the Bidder to continue performance of the Contract with such adjustments as may be required by the existence of the force majeure and agreed upon by both parties.



**25. Hot Work Procedure**

Take all precautions to Work safely and to provide the necessary protection to persons and property from Hot Work. This includes, but is not limited to Brazing, Cutting, Grinding, Soldering, Thawing Pipe, Torch Applied Roofing and Welding. With all such activity these steps are to be followed:

- i. Whenever possible, complete Hot Work in a welding shop or out of doors at the school.
- ii. Flammable liquids, dust lint and oily deposits to be removed from within 50-ft (15m) of Work. Remove other combustibles where possible. Otherwise protect with fire-resistive tarpaulins or metal shields.
- iii. Explosive atmosphere in area eliminated. Floors swept clean. Combustible floors wet down, covered with damp sand or fire-resistive tarpaulins.
- iv. All wall and floor openings covered. Fire-resistive tarpaulins suspended beneath Work.
- v. For on-site Work (indoor and out of doors), advise the Head Custodian, Principal, Consultant (if assigned) and Project Coordinator/Lead prior to Work being performed, and of related dangers.
- vi. Where the Fire Alarm system is required to be set to stand-by to discourage false alarms from smoke detectors provide a firewatch throughout the building or structure being worked on. NEVER put the fire alarm system in stand-by mode when the building is occupied by staff or students.
- vii. In the event of a fire as a result of the Hot Work, notify the fire department immediately. Report incident to the head custodian, the Consultant, if assigned, and Project Coordinator immediately, whether extinguished or not. Provide a fire incident report to the Board.
- viii. Barriers must be set up to protect staff and students (i.e. pylons, shields, and caution tape) from exposure to arc flash and smoke migration.
- ix. Have all necessary doors, windows and/or drapes closed. Confer with the Head Custodian to shut down all fan systems in the area to reduce or eliminate smoke distribution.
- x. Provide and keep fire extinguishers handy and in good Working condition. Temporarily cover all smoke detectors in the area during time of Work.
- xi. Provide a fire watch/spot check for several hours after Work is completed. Uncover smoke detectors.
- xii. On new construction, the requirements of the Hot Wok permit may be waived, until such time as either Substantial Completion or Occupancy is granted, whichever comes first.

- xiii. On additions to existing buildings, the requirements for Hot Work permits shall remain in place.

**25.1 Hot Work Permit**

- i. Each permit is valid for seven (7) days only and must be renewed prior to its expiration date
- ii. The contractor must obtain Hot Work Permits from the School Board's representative prior to the start of work.
- iii. The contractor must complete the form as required and must keep the form on site.
- iv. Return each completed form to the School Board's representative on the date of expiration.
- v. The most current version of the Permit and its requirements shall be used for the purposes of the Work.

**26. Incurred Costs**

The Board will not be liable, nor reimburse any Bidder for costs incurred in the preparation of the Bid, or any other services that may be requested as part of the procurement process.

**27. Indemnification**

The Bidder will indemnify and save harmless and defend the Board, and their respective elected officials, officers, employees, agents and their respective successors and assigns, from and against all actions claims and demands whatsoever which may be brought against or made upon any of the Indemnified Parties and against all losses, liability, judgments, claims, costs, demands or expenses which the Indemnified Parties may sustain, suffer, or be put to resulting from or arising out of the Bidder's failure to exercise reasonable care, skill or diligence in the performance or rendering of any Work or service required hereunder to be performed or rendered by the Bidder, its agents, servants, employees or subcontractors, or any of them as well as for the infringement of or use of any intellectual property rights including any copyright or patent arising out of the reproduction or use in any manner of any plans, designs, drawings, specifications, information, negatives, data, material, sketches, notes, documents, memoranda, or computer software furnished by the Bidder in the performance of this Contract.

**28. Insurance Provisions**

If selected, it is the responsibility of the Vendor/Contractor and its Insurance Broker to review all potential operations and exposures to determine if the coverage and limits noted below are sufficient to address all insurance related exposures presented by the specification of the Project, Work, or Supply. The Vendor/Contractor shall insure its

---

undertaking, business, and equipment under the following coverage to protect and indemnify and save harmless the Board:

- i. **General Liability Insurance:** The Vendor/Contractor shall maintain liability insurance acceptable to the Board throughout the term of this Agreement from the date of commencement of work until one (1) year from the date of substantial performance of work. Liability coverage shall be provided for completed operations hazards from the date of substantial performance of the work, as set out in the certificate of substantial performance of work, on an ongoing basis for a period of 6 years following substantial performance of work. Coverage shall consist of a comprehensive policy of public liability and property damage insurance, with all applicable coverage extensions/endorsements, in an amount of not less than \$10,000,000 per occurrence. Such insurance shall name the **Waterloo Region District School Board** and any other person or party identified in the contract documents, as an **additional insured** with a cross liability endorsement and severability of interests' provision. The policy SIR/deductible shall not exceed \$100,000 per claim and if the policy has an aggregate limit, the amount of the aggregate shall be double the required per occurrence limit. A combination of primary coverage plus umbrella or excess liability insurance may be used.
- ii. **Owned and Non-Owned Automobile Liability Insurance:** The Vendor/Contractor shall maintain liability insurance on all Owned, Non-Owned and Leased Automobiles used in the performance of this work to a limit of \$2,000,000 per occurrence throughout the term of this Agreement from the date of commencement of work and until one (1) year after the date of substantial performance of work.
- iii. **Broad Form Contractor's Equipment Insurance:** The General Contractor shall provide and maintain during the term of the Agreement, coverage for construction machinery and equipment used by the Contractor for the performance of the work. Such insurance shall be in a form acceptable to the Board and shall not allow subrogation claims by the Insurer against the Board.
- iv. **If applicable**, the General Contractor shall provide and maintain during the term of the Agreement an **All Risk Installation Floater Insurance** policy covering the installation of any machinery and equipment associated with the construction project. Coverage shall be in an amount equal to the value of the machinery and/or equipment and shall include coverage while it is in transit to, while stored at a temporary location, and awaiting installation at the work site.
- v. **If applicable**, the General Contractor shall **ensure** its professional consultants, architects, landscape architects, planners, and engineers providing a professional service in connection with the contract, maintain until three (3) years after the

---

Agreement, **Professional Liability Insurance** to a limit not less than \$1,000,000 per claim providing coverage for acts, errors and omissions arising from their professional services performed under this Agreement. The policy SIR/deductible shall not exceed \$100,000 per claim and if the policy has an aggregate limit, the amount of the aggregate shall be double the required per claim limit. Certificates evidencing such coverage shall be supplied to the Board prior to the completion of the project and in accordance with the provisions stated above.

- vi. **If applicable, (i.e., for projects with environmental liability concerns)** the General Contractor shall take out and keep in force **Contractor's Pollution Liability (CPL)** coverage to ensure that its work does not exacerbate any pre-existing environmental condition during construction. Coverage shall be in an amount of not less than \$2,000,000 per claim or per occurrence, or such greater amount as the Board may from time to time require, naming the Board as an additional insured, whose coverage shall be maintained in force for 1 year following the termination of the Contract. The policy SIR/deductible shall not exceed \$100,000 per claim and if the policy has an aggregate limit, the amount of the aggregate shall be double the required per occurrence limit.
- vii. **Provisions:** Prior to the commencement of work, the General Contractor shall forward a Certificate of Insurance evidencing this insurance with the executed Agreement. The Certificate shall state that coverage will not be suspended, voided, canceled, reduced in coverage or in limits except after thirty (30) days (ten (10) days if cancellation is due to non-payment of premium) prior written notice by certified mail to the Board.

It is also understood and agreed that in the event of a claim any deductible or self-insured retention under these policies of insurance shall be the sole responsibility of the General Contractor and that this coverage shall preclude subrogation claims against the Board and any other person insured under the policy and be primary insurance in response to claims. Any insurance or self-insurance maintained by the Board and any other person insured under the policy shall be considered excess of the Contractor's insurance and shall not contribute with it. The minimum amount of insurance required herein shall not modify, waive or otherwise alter the Contractor's obligation to fully indemnify the Board under this Agreement.

The Board reserves the right to modify the insurance requirements as deemed suitable.

- viii. **Third Party Claims Process:**
  - a. The Board's claims process for Third Party claims is to refer the claimant directly to the Vendor/Contractor and to leave the resolution of the claim

with the Vendor/Contractor. This applies regardless of whether or not it is an insured loss.

- b. As the Board has a responsibility to the taxpayers, we must ensure that claimants are dealt with in a fair and efficient manner. Claims reported to the Vendor/Contractor, either directly by a third party or through the Board shall be promptly investigated by the Vendor/Contractor. The Vendor/Contractor shall contact the third party claimant within 48 hours of receipt of notice of a claim. The Vendor/Contractor shall initiate an investigation of the claim immediately upon notice, and advise the third party claimant in writing, with a copy to the Board, of its position regarding the claim within 21 calendar days of the notice. The Vendor/Contractor shall include in its response the reasons for its position.
- c. Should this position not resolve the claim and be accepted by the third party claimant, the Vendor/Contractor shall immediately report the claim to its Insurer for further review. (Insurer for this purpose is defined as either the Claims Department of the Vendor/Contractor's Insurance Company or the Claims Administrator at the Vendor/Contractor's Insurance Broker.) The Vendor/Contractor's Insurer upon receipt of this claim shall advise the third party claimant by letter, with a copy to the Board, that it is now investigating the claim. When a final position on the claim has been determined, the Vendor/Contractor's Insurer shall advise the third party claimant by letter, with a copy to the Board. Failure to follow this procedure shall permit the Board to investigate and resolve any such claims.
- d. Nothing herein shall limit the right of the Board to investigate and resolve any such claims notwithstanding the response of the Vendor/Contractor and/or its Insurer and to seek indemnification from the Vendor/Contractor or to exercise any other rights under the Contract.
- e. The Board may, without breaching this contract, retain from the funds owing to the Vendor/Contractor an amount that, as between the Board and the Vendor/Contractor, is equal to the balance in the Board's favour of all outstanding debts, claims or damages, whether or not related to this contract.

## **29. Invoice Requirements, Proper Invoice and Payment Terms**

Except for Credit Card payments, all invoices shall be sent to [finance-ap@wrdsb.ca](mailto:finance-ap@wrdsb.ca) for payment at the completion of the Work or after receipt of goods, unless otherwise stated.

- 29.1** In advance of invoicing, upon request, contracted Vendors will provide:
- i. necessary company information to set up a WRDSB account and
  - ii. banking information if they wish to receive payment by Electronic Funds Transfer (EFT).

- 29.2** Requests to change company information, such as a name change due to a merger or acquisition, must be submitted in writing accompanied with a legal document/letter signed by a lawyer on the law firm's letterhead.
- 29.3** Invoices, not subject to the Construction Act, must contain the following information, where applicable, in order to be deemed complete:
- i. Purchase Order Number
  - ii. Work Order Number
  - iii. Invoice Date
  - iv. Unique Invoice Number
  - v. Vendor name and address
  - vi. Contract reference (RFT #, RFQ# etc.)
  - vii. A description, including quantity where appropriate, month of service for ongoing contracts, and location of work
  - viii. The amount payable for the services or materials that were supplied, including unit price (where applicable)
  - ix. HST amount shown as a separate line item
  - x. Payment Terms
  - xi. Board Project Lead/ Contact and
  - xii. Confirmation of completion of order and all Work as described in this Bid Solicitation Document.

**29.4 Construction Act – Proper Invoice**

The Board will pay such invoice within twenty-eight (28) calendar days of the Board's receipt of such proper invoice if the work has been performed to the satisfaction of the Board For Work that is governed by the provisions of the Construction Act and the Regulations thereto, the successful Bidder shall submit its invoices in the form of a Proper Invoice. For the purposes of this section, a "Proper Invoice" shall include the following:

- i. the Vendor/Contractor's name, address, telephone number and mailing address.
- ii. the date of the Proper Invoice and the period during which the services or materials for which payment is being applied for were supplied.
- iii. information identifying the authority, whether in the contract or otherwise, under which the services or materials were supplied.
- iv. a description, including quantity where appropriate, of the services or materials that were supplied during the payment period.
- v. the amount payable for the services or materials that were supplied during the payment period, with a clear identification of the portions of the amount that are holdbacks, and HST.
- vi. the name, title, telephone number and mailing address of the person to whom payment is to be sent.

- vii. the payment terms as specified by the Board in the Contract.
- viii. the invoice number and if applicable, the revision number.
- ix. the Vendor/Contractor's HST number.
- x. invoices and time sheets from all subtrades whose work is included in the Proper Invoice, if required in the Contract.
- xi. backup documentation to support any cash allowances and extra work claimed in the Proper Invoice.
- xii. a schedule of values indicating:
  - a. for lump sum contracts, the percentage of work completed per division with each division further subdivided to show the percentage of work completed for each subtrade,
  - b. for unit price contracts, the tender quantity, unit of measure, previous quantity, current quantity, to-date quantity,
  - c. an updated list of change orders, showing the percentage of work completed under each change order, and
  - d. an updated cash allowance list, showing the percentage of work completed in respect of each cash allowance, if required by the Contract.
- xiii. a Statutory Declaration where required by the Contract attesting to the truth of the statements made therein.

### **29.5 Payment Terms**

The payment terms shall be net twenty-eight days (28) days after receipt of proper invoice where the Construction Act is applicable, unless otherwise agreed by the Board in writing. All other payment terms will reflect Net 30. An early payment discount, if offered, may be considered on a mutual agreement basis. Payment may be delayed if the invoice is incorrect or the goods, equipment and/or services are not acceptable to the Board. The Board will not pay any interest, penalty, or late fee for delayed payments. The Board preferred payment method is Credit Card or EFT, however alternate payment methods may be approved. Vendors are required to invoice promptly, without delay.

### **30. Licenses and Permits**

The successful bidder will be responsible for applications and fees associated with any and all licenses and permits required by any and all governing bodies. The successful bidder will attach a copy of all permits, and any other required documentation to the applicable assigned work order for Board records.

### **31. Locates, if applicable**

All required utility locates must be obtained before any on-site work commences, be available for Vendor/Contractor operator/employee review, and are the sole responsibility of the successful bidder. Any damage to any utility installation arising from work performed by the Vendor/Contractor or their employees shall be the

Vendor/Contractor's responsibility.

The successful Bidder will obtain all utility locates in advance of work and all cost(s) associated with obtaining the utility locates will be the Vendor/Contractor's responsibility.

The successful Bidder shall possess the ability to supply and or share with the Board Representative utility locates for the sole purpose of Quality Control inspections. This is to be done at no additional cost to the Board.

**32. Materials - Specifications**

Only new materials in perfect condition will be accepted. Demonstrators, seconds or defective materials are unacceptable. Any materials found not to be in a new condition or as specified will be returned to the successful Bidder at the successful Bidder's expense.

**33. Material Safety Data Sheets (M.S.D.S.)**

Where applicable, a materials safety data sheet (M.S.D.S.), must accompany all purchased goods, that fall under the requirements of the Occupational Health and Safety Act. The Board will not accept any additional charges or surcharges related to the supplying of M.S.D.S.

**34. Mathematical Errors (Unit Prices Prevail)**

Should there be any error in extensions, additions or computations, the Board shall be entitled to correct such errors based upon the unit prices supplied, and the corrected total shall be considered as representing the intention of the Bidder and shall be used as the basis for comparison of bid submissions.

**35. No Branding**

The Vendor/Contractor shall not place any sign at the site, public meetings, any public or private property or along curbside prior, during or after the Work without prior written permission of the Board.

**36. No Collusion**

Bidders including any of their agents are prohibited from engaging in any comparison of figures or arrangement with any other individual, corporation or person submitting a Bid for the same Work and shall be fair in all respects and shall be without collusion or fraud.

**37. No Lobbying**

Any attempt by the Bidder or its agents to contact any of the following persons, directly or indirectly, with respect to this procurement may lead to disqualification:

- i. any elected or appointed officer.
- ii. any staff of the Board except the Single Point of Contact as identified in the Bid Solicitation Document; or
- iii. any other person connected in any way with the procurement.



**38. No Smoking and Scent-Free Environment**

The Province of Ontario has legislated under the Smoke Free Ontario Act that smoking is not permitted on any Board owned properties. Furthermore, most Board properties are “scent free”. Smoking will not be permitted on-site. Offenders will be asked to leave the site, and infractions could result in corrective action and or fine.

**39. Non-Assignment**

No assignment by the Vendor/Contractor shall relieve the Vendor/Contractor of any responsibility for the full performance of all its’ obligations under this contract.

The Vendor/Contractor shall not change its corporate name without the prior written approval of the Board.

**40. Non-Disclosure Agreement (NDA)**

The Board requires all service providers to sign off on a non-disclosure agreement and for the service provider to complete the Software Privacy and Security Standards Document (if necessary) in accordance with Board procedure AP4790. Prior to any sharing of Board personal, sensitive, or confidential information, the Vendor will be subject to further privacy and security reviews as required. This agreement will be renewed on an annual basis.

**41. Ownership of Work**

For the purposes of this paragraph:

**“Deliverables”** means all material prepared by the Bidder forming the Work under this Contract including, without limitation, all electronic media, reports, documents and instruments of service.

**“Intellectual Property Rights”** means any and all rights provided under: (a) patent law; (b) copyright law; (c) trade-mark law; (d) industrial design law; (e) any other statutory provision or common law principle applicable to this Contract, including trade secret law; and (f) any and all registrations and licenses in relation to the foregoing; and

**“Personnel”** means employees, representatives, agents and subcontractors.

The Bidder and the Board acknowledge and agree that the development of the Deliverables and the provision of the Work may result in the creation or development of new intellectual property and may contain or utilize the existing intellectual property of the Bidder or of third parties. Accordingly, the Bidder and the Board agree as follows.

- i. Except as set out in paragraph (b) below, the Bidder hereby assigns and agrees to assign to the Board all right, title and interest, including all Intellectual Property Rights, in and to each Deliverable from the moment of creation, and will cause its Personnel to assign the same. The Bidder will cause its Personnel to waive all moral rights they may have in each Deliverable.
- ii. To the extent that a Deliverable contains or utilizes the intellectual property of the

Bidder or a third party (“Retained Materials”), and the Bidder expressly identifies such Retained Materials, the Bidder and the applicable third party will, subject to the following sentence, retain all their respective right, title and interest, including all Intellectual Property Rights, which each may have in such Retained Materials. To the extent that a Deliverable contains or utilizes Retained Materials, the Bidder hereby grants to each of the Board a royalty-free, irrevocable, perpetual, world-wide, non-exclusive license to make, use, sell, modify, prepare derivative works, disclose, publish, sublicense, copy and communicate by electronic means such Retained Materials.

- iii. The Vendor/Contractor agrees to always cooperate fully, and will cause its Personnel to cooperate fully at all times, with respect to signing such documents and doing such acts and other things reasonably requested by the Board to confirm the transfer of ownership rights in the Deliverables.

**42. Patent, Copyright and Other Proprietary Rights**

The Bidder (by responding) agrees that the Bid on acceptance by the Designated Representative, become the property of the Board. The copyright for respective purchased concepts and/or materials will become the property of the Board unless otherwise mutually agreed upon by the Bidder and the Board.

All Bids, other documents as well as correspondence are subject to the provisions of the Municipal Freedom of Information and Protection of Privacy Act (MFIPPA).

**43. Performance**

- i. Where the Vendor/Contractor is in default in carrying out any of its obligations under the contract, the Board may issue a verbal warning outlining the deficiency in supply or other aspects of performance and requiring the Vendor/Contractor to correct those deficiencies within such period of time as stated.
- ii. If the deficiency is not corrected within the time specified, or there is a further instance of deficient performance, the Board may issue a written notice to the Vendor/Contractor, identifying the deficiency in performance and setting a final date or time period for its correction.
- iii. If corrective steps are not taken by the final date or within that time, the Board may terminate the Contract and take corrective action.
- iv. Termination of any Contract can be immediate depending on the severity of the default.
- v. The Vendor/Contractor shall have no right to perform the services contemplated under this agreement beyond the time when such services become unsatisfactory to the Board; and in the event that Vendor/Contractor shall be discharged before all the services contemplated hereunder have been completed, or the services are for any reason terminated, stopped or discontinued because of the inability of the

Vendor/Contractor to serve under this agreement they shall be paid only for that portion of the Work which shall have been satisfactorily completed at the time of termination.

- vi. Where deemed appropriate, a performance evaluation shall be completed by the Board. The evaluation report shall be reviewed with Procurement Services, and a copy of the completed evaluation forwarded to the Vendor for their records. Dependent on the evaluation scoring, the Board may request a corrective action plan and/or project size/value may be affected on future bid opportunities for your company.

**44. Permits and Licenses**

Unless stated otherwise, the Vendor/Contractor shall apply for all required permits and licenses, supply all necessary notices required for the Work and pay all required fees. These costs shall be included in the Total Price. A copy of all permits, and any other required documentation shall be provided the Board upon request.

**45. Proceedings Against the Board**

The Bidder represents and warrants that the Bidder is not a party to any legal suits, actions, litigation proceedings, arbitrations, alternative dispute resolutions, investigations, or claims (Hereinafter collectively referred to as "Claims") by or against or otherwise involving the Board and the Bidder. The Board may reject any Bid in the event of potential, current, pending, or threatened litigation, arbitration, alternative dispute resolution or disputes involving the Board and the Bidder.

**46. Protection of Board Assets**

The successful Bidder (the contractor / subcontractor) shall be informed of and protect all Board assets including existing structures and vehicles, to the satisfaction of the Board. Any damage shall be reported to the Board and subsequently repaired and/or replaced by the Vendor/Contractor, at their expense, to the satisfaction of the Board. The Vendor/Contractor shall not cause any inconvenience to Board operations, staff, public or users of the Board facilities, within reason. Communication between the successful Vendor/Contractor and the school (or Board representative if school contact is not available) must be timely and effective to ensure all stakeholders are considered / aware of work to be completed.

**47. Public Health Safety Protocol**

Best practices include but not limited to wearing a medical grade mask and maintaining physical distancing (2m/6.5ft).

Recommended practices are subject to change at any time For information and updates, refer to the following resources and website: [Waterloo Region District School Board](#) and [Regional of Waterloo Public Health Services](#)

**48. Records, Inspection, Audits**

The Board will have the right, upon reasonable notice, to full access to the accounts and records of the Vendor/Contractor in respect of the goods, services and equipment provided by it under the Contract, for the purposes of inspection and/or audit. The Vendor/Contractor shall make and retain such records during the term of the Contract and for a minimum of seven (7) years following its termination, cancellation, or expiry.

**49. Reserved Rights of the Board**

The Board reserve the right, in their respective sole and unfettered discretion, to:

- i. Reject any Bid received from a Bidder which is party to any potential, current, past or existing suits, actions, and litigation proceedings, arbitrations, alternative dispute resolutions, investigations, Bidder performance evaluations that are below expectations, or claims by or against or otherwise involving either of the Board and the Bidder.
- ii. waive formalities and accept Bids which substantially comply with the requirements of this tender.
- iii. accept any Bid in whole or in part.
- iv. accept, reject, or cancel any or all Supplementary pricing.
- v. discuss with any Bidders different or additional terms to those contemplated in this Bid Solicitation Document or in any Bid submission.
- vi. make public the names of any or all Bidders.
- vii. accept or reject equivalent or alternative brand names.
- viii. check references other than those provided by any Bidder.
- ix. reject any, or any part of, any or all Bids, or cancel the bidding process at any stage and/or issue a new Bid call for the same or similar deliverables.
- x. disqualify any Bidder:
  - a. whose Bid contains misrepresentations or any other, inaccurate, or misleading information, or any qualifications within its Bid,
  - b. who has engaged in conduct prohibited by the Bid Solicitation Document,
  - c. with inadequate credentials or due to unsatisfactory past performance,
- xi. reject Bid(s) from Bidder who has engaged in lobbying or has contravened any of the terms of the Bid Solicitation Document.
- xii. reject a Bid based on:
  - a. information provided by references or credit check or other due diligence efforts,
  - b. the information provided by a Bidder pursuant to the Board exercising its clarification rights under the procurement process, or
  - c. other relevant information that arises during the procurement process.
- xiii. choose to reject a Bid if only a single Bid is received and cancel the bidding process or enter into direct negotiations with the sole Bidder.
- xiv. accept a Bid other than the lowest or highest scoring and/or to not accept any Bid

- for any reason whatsoever.
- xv. award the contract as split-order, lump sum or individual-item basis, or such combination as shall best serve the interests of the Board
  - xvi. negotiate in circumstances permitted for in the Bid document or by relevant policies, or directives, and include additional terms and conditions during the process of negotiations.
  - xvii. no longer consider a Bidder if a satisfactory outcome is not reached as part of negotiation, as determined by the Board in their sole discretion and move to the next highest ranked Bid in such event.
  - xviii. select a Bidder other than the Bidder whose Bid reflects the lowest cost to the Board and/or award the Contract to any Bidder.
  - xix. award any business/Work described in this Bid Solicitation to more than one (1) Bidder.
  - xx. not award the Contract if the costs of completing the Work exceed budget funding; or
  - xxi. do not respond to all requirements or do not represent fair market value or where necessary internal approvals are not obtained.

These reserved rights are in addition to any other expressed rights or any other rights which may be implied in the circumstances. The Board shall not be liable for any expenses, costs or losses suffered by any Bidder or any third party resulting from the Board exercising any of its express or implied rights under this bidding process.

#### **50. Responsibilities of the Vendor**

Acceptance of a purchase order issued by the Board and/or a signed agreement shall constitute a contract (the "Contract") between the Board and the Vendor, which shall bind the Vendor on their part to furnish and deliver the goods, equipment and services at the prices given and in accordance with the conditions of the Bid solicitation document.

The Vendor shall:

- i. perform the Contract in accordance with the specifications, terms and conditions under which it is awarded.
- ii. act in a professional manner at all times when dealing with Board staff, with the public, and while working on site.
- iii. not, except with the consent of the Board in writing, release information relating to any subsequent order for advertising, promotional or technical purposes or otherwise give it publicly in any fashion, nor shall the name of either of the Board be used for, or in connection with, any advertising or promotional purpose of the Vendor.
- iv. treat information gained while working with the Board confidentially and not use it for any other project and return it to the Board if requested.

- v. submit to Finance – Accounts Payable, an invoice for payment at the completion of the Work, unless otherwise stated. All applicable taxes including HST are to be itemized separately on invoices. Include the purchase order number on each invoice; and
- vi. provide necessary information if they wish to receive payment by Electronic Funds Transfer (EFT).

**51. Site and Work Examination**

- i. Bidders will accept the site conditions, and the requirements of the Work, as is. No modifications to the Bid will be accepted after the Closing Time.
- ii. No claim for extras will be allowed for Work or difficulties encountered due to conditions of the site which were visible, knowable, or reasonably inferable, prior to the time of submission of Bid. Bidders shall accept sole responsibility for any error or neglect on their part in this regard.
- iii. Before submitting a Bid, each Bidder shall:
  - a. carefully examine this entire Bid Solicitation Document to determine the extent of the Work, and various provisions including the maps, drawings, reports and specifications.
  - b. immediately report all discrepancies between the various documents and site conditions.
  - c. provide subcontractors, sub-consultants, and suppliers to whom the Bidder intends to sublet a portion or portions of the Work with complete information as to the requirements of the Work. This is to include maps, drawings, reports, specifications, and all requirements of the Bid Solicitation Document including any addenda.
- iv. In the event of discrepancies between the maps, drawings, reports, and the specifications with regard to quantity or quantities of materials or items, and in the absence of Addenda in clarification of said discrepancies, the Bidder is to include for the larger quantity or quantities.
- v. No additional payments will be made for any costs incurred through failure of the Bidder to abide by provisions stipulated in all of the articles and sub-articles of this item.
- vi. Any soils investigation, environmental, geotechnical or other reports prepared or obtained with respect to the Place of the Work (collectively the “Reports”) are available from the Consultant. Where the Work involves existing buildings, structures, facilities, plant or equipment, any reports, data or as-built drawings concerning such buildings, structures, facilities, plant or equipment (collectively the “Data”) are available from the Consultant. The Reports should not be considered a representation of the site conditions of the entire Place of the Work, and the Reports and Data are provided for general information and guidance purposes only. Neither the Owner nor the Consultant guarantees the accuracy or

completeness of the Reports or the Data, nor does either assume any responsibility for any interpretations or conclusions that bidders may make or draw from the Reports or the Data.

- vii. Each Bidder is solely responsible, at its own cost and expense, to carry out its own independent research and due diligence, or to perform any other investigations considered necessary by the Bidder to satisfy itself as to all existing conditions. The Bidders' obligations set out in this paragraph apply irrespective of any Reports, Data or any information contained in the Bid Documents.
- viii. No allowances will be made for additional costs and no claims will be entertained in connection with conditions which could reasonably have been ascertained by investigation or other due diligence undertaken prior to the Submission Deadline, and/or in connection with Work which is required and which is reasonably inferable from the Bid Documents, the Reports and/or Data as being necessary.

**52. Site Existing Services, if applicable**

The position of utility pole lines, underground conduits and services, watermains, sewers and other underground and over ground utilities and structures are not necessarily known, and the accuracy of the position of such utilities and structures on any reference documents is not guaranteed. The Board will not be responsible for damages or extra work caused or occasioned by the Vendor/Contractor relying on this or any other information or records.

Before starting work, the Vendor/Contractor shall familiarize themselves of the exact location of all such utilities and structures and shall assume all liability for damage to them. Where extra measures are required to support utility poles during construction either by the utility involved or the Vendor/Contractor themselves, the costs involved shall be borne by the Vendor/Contractor. The Vendor/Contractor will be responsible for any fees that may be associated with these services.

**53. Site Inspection and Control**

A representative of the Board (appointed by the Board) reserves the right to enter the site at any time for the review & inspection. The presence of a said representative does not indicate satisfaction or compliance unless these comments are made by the representative and submitted to the Vendor/Contractor in written form

**54. Site Investigation**

Bidders shall not rely solely upon information furnished by the Board but shall do their own investigation of the locations, and quantity of the work to be completed under this contract.

The Bidder assumes all risk of conditions, existing or arising, in the course of the work, which might or could make the work or any items therefore more expensive in character, or more onerous to fulfill, than was contemplated or known when the Bid was made, or the Contract signed.

**55. Site Safety and Clean Up**

For safety of students, staff, and community members alike, it is expected that cleanup operations will progress with the job.

Repair work will be carried out by skilled workers acceptable to the Board Representative, under the liability of the Vendor/Contractor.

The Board Authorized Representative must approve all repairs and replacements prior to final payment.

**56. Site Traffic/Pedestrian Safety**

Vehicles, including Couriers and movable Equipment/Machinery must take all precautions to avoid entering or driving on Board premises during nutritional breaks, before and after school hours, or anytime there are students or staff outside of the building.

**57. Site Use and Traffic Control**

Vendor/Contractor's activities shall be limited to areas for work and storage as directed by the Board. Except where expressly permitted by the Board, materials and/or equipment must not be stored within four metres of the travelled portion of any roadway. Notwithstanding the foregoing, the Vendor/Contractor shall, at their own expense, remove any equipment or material, which, in the Board's opinion, constitutes a traffic hazard.

The Vendor/Contractor shall plan and schedule the routes of vehicles transporting all materials to, from or within the job, so that vehicular movements are accomplished with minimum interference and interruption to traffic. This will necessitate vehicles to "slip off" or "slip on" in the direction of traffic lanes.

The Vendor/Contractor shall maintain the adjacent side streets in a condition free from debris resulting from their operations, such as materials spilling from trucks. It is expected that the Vendor/Contractor shall regularly inspect the surface condition of these streets and promptly dispose of all the debris.

Should the Vendor/Contractor be unable to carry out the required remedial measures, the Board may carry out the necessary maintenance and the costs for the work shall be deducted from payments due to the Vendor/Contractor.

The Vendor/Contractor shall, at his own expense and to the satisfaction of the Board, provide all vehicular traffic control equipment, material, and labor required to perform the work in a safe manner in accordance with the "Occupational Health and Safety Act" and the "Ontario Traffic Manual" (Book 7). The Vendor/Contractor shall assure that all required forms are completed and on-site for inspection. In the event a traffic control company is contracted for the purpose of signage, information regarding the Vendor/Contractor must be included in the quotation and included with the bid price.



The Vendor/Contractor shall be responsible for the supply of traffic flag person(s) where required under the "Ontario Traffic Manual" (Book 7), with all costs included in the base unit price.

**58. Suspension of Bidders**

At the sole discretion of the Manager of Procurement Services, any Bidder may be suspended from consideration for default of delivery, unsatisfactory performance, safety concerns, lobbying or contravention of the Bid Solicitation Document.

**59. Sustainable Purchasing**

The procurement needs of the Board represent a significant level of responsibility to demonstrate leadership and support for greener business practices. Integrating environmental performance and impact into supply chain decisions is a commitment to improvement of the environment and the quality of life.

Green procurement shall be viewed in the context of achieving value for money for the total life-cycle costs. It requires the inclusion of environmental impact considerations into the procurement process, including planning, acquisition, use and disposal. Value for money shall include the consideration of many environmental tangible and intangible factors when determining the total life-cycle costs and environmental impact.

**60. Termination**

If the Vendor/Contractor fails to comply with any provision of this agreement or otherwise fails to perform its obligations hereunder in a competent manner satisfactory to the Board, the Board may give the Vendor/Contractor notice in writing of such failure. If the Vendor/Contractor has not remedied its failure within ten (10) working days of the said notice, the Board shall be entitled to exercise any one or more of the following remedies:

- i. The Board may terminate the contract without further notice, and exercise its rights to the Contract security provided by the Vendor/Contractor.
- ii. The Board may withhold any payment due to the Vendor/Contractor hereunder until the Vendor/Contractor has remedied its failure.
- iii. The Board may engage the services of another Bidder to remedy the Vendor/Contractor's failure, and obtain reimbursement therefore from the Vendor/Contractor. The said reimbursement may be obtained either through deduction from any amounts owing to the Vendor/Contractor hereunder, or through any other legal means available to the Board; or
- iv. The Board may assert any other remedy available to it in law or equity.

Unless the Board expressly agrees to the contrary, any failure of the Board to exercise any of the foregoing remedies, or the granting of any extension or indulgences, shall not be prejudicial to any right of the Board to subsequently obtain such remedies.

**61. Termination for Convenience**

The Board may terminate the Contract, in whole or in part, whenever the Board determine that such termination is in the best interests of the Board without showing cause, upon providing written notice to the Vendor/Contractor. The Board shall pay all reasonable costs incurred by the Vendor/Contract up to the date of termination considering the Work performed and/or services were provided in accordance with the Contract and to the complete satisfaction of the Board. Payment shall be in accordance with prices as per Contract. However, in no event shall the Vendor/Contractor be paid an amount, which exceeds the Total Bid Price. The Vendor/Contractor will not be reimbursed for any profits which may have been anticipated but which have not been earned up to the date of termination.

**62. Termination for Lack of Funding**

Should the Board fail to appropriate funds to enable payments including multi-year agreements, the Board may cancel the contract without termination charges, provided the Vendor/Contractor receives thirty (30) days written notice of such termination from the Board.

**63. Tools and Equipment**

All equipment and methods used to carry out this Contract shall be in accordance with best practices, guidelines, regulations, and standards with respect to safety and quality.

No equipment, tools or materials are to be stored or left overnight within Board property.

At the time of bid, if requested, the bidders will indicate the type of equipment that will be used to fulfill the terms and conditions of this contract. Prior to the Board entering into an agreement with the Vendor/Contractor, or at any time during the Contract, the Board may, at their discretion, request an inspection of the equipment proposed for use.

It is the responsibility of the Vendor/Contractor, in the event of a major mechanical equipment breakdown, to have available substitute equipment of similar capability. It shall be supplied and put into service to fulfill the timeline terms of this tender. Failure to provide alternative equipment within timeline expectations specified within this tender, may result in termination of the contract. It is the responsibility of the Vendor/Contractor to ensure work continues and deadlines are met, despite any unforeseen interruption as a result of equipment failure.

It is the Vendor/Contractor's responsibility to ensure that the equipment and the operator, are licensed in accordance with the Ministry of Transportation. The Board may, at their discretion, require the Vendor/Contractor to provide proof that the equipment has passed a recent (within the last 12 months) government safety inspection and that the operators are suitably licensed prior to commencement of the contract. All vehicles, tools, equipment, and voltage rated gloves requiring dielectric testing shall have current certification and all applicable documentation.

The equipment must be in good working order and the Vendor/Contractor is responsible for all general and preventative maintenance, fuel, and repair and those costs shall be included in the bid. All preventative maintenance and repairs are to be conducted off peak hours. No other charges to the Board shall apply.

**64. Usage Reports**

The Board, at no additional cost, may request usage reports to be provided annually or upon request.

**65. Variation of Bid Prices**

No variation in the Total Price, unit prices and/or provisional pricing will be permitted after Closing Time, except in the instance of variation solely due to an increase or decrease in the rate of eligible taxes, beyond the control of the Bidder, occurring after the time of submission of their Bid. An increase or a decrease in the rate of eligible taxes, under these circumstances, shall alter the price of the Bid, but only to the extent of the tax increase or decrease.

**66. Volume and Exclusivity**

The Board makes no guarantee of value or volume of work to be assigned to the Successful Bidder. Any agreement executed with the Successful Bidder may not be an exclusive contract for the provision of the described goods/services.

**67. Waiver**

No term or provision of the Bid Solicitation Document shall be deemed waived, and no breach consented to, unless such waiver or consent is in writing and signed by an authorized representative of the party claimed to have waived or consented to the breach. No consent by a party to, or waiver of, a breach under the procurement process shall constitute consent to, waiver of, or excuse for any other, different, or subsequent breach.

The Board does not accept responsibility for any information or any errors or omissions which may be contained in the Bid Solicitation Document, or the data, materials or documents disclosed or as provided to the Bidders pursuant to the procurement. The Board make no representation or warranty, either expressed or implied, in fact or in law with respect to the accuracy or completeness of the Bid Solicitation Document or such data, materials or documents and the Board shall not be responsible for any actions, costs, losses or liability whatsoever arising from any Bidder's reliance or use of the Bid Solicitation Document or any other technical or historical data, materials or documents provided by the Board. The Bidder is responsible for obtaining its own independent financial, legal, accounting, and technical advice with respect to any information included in the Bid Solicitation Document or in any data, materials, or documents provided or required by the Board.

**68. Warranty and Maintenance**

The Vendor/Contractor, at the time of substantial completion, shall furnish a written

warranty covering material, maintenance, and work performed under the contract for a minimum period of two (2) years from the date of completion. Individual sections may extend warranties beyond the two (2) year time frame. The Vendor/Contractor is responsible for all required maintenance complete with materials and labour during the warranty period.

**69. Work Continuity**

The Vendor/Contractor shall take adequate care to protect the Work, the Board's property, adjacent properties and shall be fully responsible for any damage or injury due to their act or neglect or is attributable to the acts or omissions of the Vendor/Contractor, its subcontractors, suppliers, agents, employees, officers, directors, and all other persons and other entities for whose acts the Vendor/Contractor may be liable or for whom it is responsible in law and their respective officers, directors, agents and employees.

The Vendor/Contractor shall ensure minimal to no disturbance to the user(s) of the surrounding facilities. Replacement and repairs due to any damage caused to any existing structure, Board equipment, public assets or private property during the Work shall be the responsibility of the Vendor/Contractor.

**70. Work Requirements**

The Vendor/Contractor shall perform entire work with minimal to no disturbance to the routine operations of the respective facility. Further, the Vendor/Contractor shall ensure safety of WRDSB assets, students, staff as well as public at all times.

**71. Workplace Safety Insurance Board (WSIB) Certificate**

The Board requires all Vendor/Contractors and service providers be in full compliance with all requirements imposed upon them by the Workplace Safety Insurance Board. All certificates of training and Safety Policies and Manuals must be available for presentation upon request.

Prior to a formal award and commencing the services covered by this Bid Solicitation, the recommended Bidder(s) make available to the Board a copy of certificates of good standing with the Workplace Safety and Insurance Board ("WSIB Certificates") stating that the vendor/contractor/consultant and all of its sub-contractors/consultants have complied with the requirements of the Workplace Safety and Insurance Act and in particular, that all requisite premiums under such Act have been paid. Where the Bidder is exempt from registration with the WSIB, the Bidder must provide evidence of such by way of written confirmation from WSIB.

WSIB Certificate evidencing renewal or replacement of Certificates shall be uploaded through the Bidding System within 72 hours of the expiration or replacement of the current certificate, without demand by the Board.

**END OF SECTION**

**00 73 00 The Supplementary Conditions**

**SUPPLEMENTARY CONDITIONS & AMENDMENTS TO STANDARD CONSTRUCTION  
DOCUMENT CCDC2 -2020 STIPULATED PRICE SUBCONTRACT**

**(the “Supplementary Conditions”)**

**AGREEMENT, DEFINITIONS, AND  
GENERAL CONDITIONS**

The Standard Construction Document CCDC 2 2020 for a Stipulated Price Contract, English version, consisting of the Agreement Between *Owner* and Contractor, Definitions and General Conditions of the Stipulated Price Contract, Parts 1 to 13 inclusive, governing same, together with the changes with the new *Construction Act* is hereby made part of these *Contract Documents*, with the following amendments, additions and modifications:

**AGREEMENT BETWEEN OWNER AND CONTRACTOR**

**ARTICLE A-1 – THE WORK**

SC17.1	A-1.3	<p><u>Amend</u> Article A-1.3 by <u>deleting</u> all of the words after “<i>Contract Documents</i>” and <u>replace</u> them with the following”</p> <p>“attain</p> <p>.1 <i>Substantial Performance of the Work</i> by the 27th day of September in the year 2024.                  .2 (if applicable) <i>Occupancy</i> by the 27th day of September in the year 2024, and                  .3 <i>Ready-for-Takeover</i> by the 27th day of September in the year 2024.”</p>
SC1.1		

**ARTICLE A-3 – CONTRACT DOCUMENTS**

SC2.1	A-3.1	<p><u>Add</u> the following documents to the list of <i>Contract Documents</i> in Article A-3.1:</p> <ul style="list-style-type: none"> <li>• Waterloo Region District School Board’s Supplementary Conditions &amp; Amendments to Standard Construction Document CCDC 2-2020 Stipulated Price Subcontract, May 2022 Version, including any Special Supplementary Conditions listed in Appendix 2 thereto</li> <li>• <i>Drawings</i></li> <li>• <i>Specifications</i></li> <li>• Performance Bond (Form 32 -Performance Bond under Section 85.1 of the <i>Act</i>) if applicable</li> <li>• Labour and Material Payment Bond (Form 31 – Labour and Material Payment Bond under Section 85.1 of the <i>Act</i>), if applicable</li> </ul>
-------	-------	--

**ARTICLE A-4 – CONTRACT PRICE**

SC3.1	A-4.4	<p><u>Delete</u> Article A-4.4 and <u>replace</u> it with the following:</p> <p>“4.4 The <i>Contract Price</i> shall remain fixed for the duration of the <i>Contract Time</i>, subject only to adjustments as provided for in the <i>Contract Documents</i>. For certainty, and without limiting the general application of the preceding sentence, the <i>Contractor</i> assumes all risks in connection with cost increases for overhead, <i>Products</i>, <i>Labour</i>, and <i>Construction Equipment</i> prescribed by the <i>Contract Documents</i> for the performance of the <i>Work</i>, and the <i>Contractor</i> assumes all responsibility for liabilities and additional costs that may arise as a result of the <i>Contractor’s</i> inclusion of any <i>Product</i>, <i>Construction Equipment</i>, <i>Supplier</i>, or <i>Subcontractor</i> in its calculation of the <i>Contract Price</i>.”</p>
-------	-------	---

**ARTICLE A-5 – PAYMENT**

SC4.1	A-5.1	<p><u>Delete</u> Article A- 5.1 in its entirety including all subparagraphs and <u>replace</u> it with the following:</p>
-------	-------	---

		<p>"5.1 Subject to the provisions of the <i>Contract Documents</i> and the <i>Construction Act</i>, the <i>Owner</i> shall:</p> <p>.1 make progress payments to the <i>Contractor</i> on account of the <i>Contract Price</i> when due together with such <i>Value Added Taxes</i> as may be applicable to such payments,</p> <p>.2 upon <i>Substantial Performance of the Work</i> as certified by the <i>Consultant</i>, and on the 61<sup>st</sup> day after the publication of the certificate of <i>Substantial Performance of the Work</i>, in accordance with the <i>Construction Act</i>, there being no claims for lien registered against the title to the <i>Place of the Work</i> and no written notices of lien delivered to the <i>Owner</i>, pay the <i>Contractor</i> the unpaid balance of the 10% holdback, together with such <i>Value Added Taxes</i> as may be applicable to such payment, less any amount stated in the <i>Owner's Notice of Non-Payment</i>.</p> <p>.3 after <i>Ready-for-Takeover</i> has been achieved in accordance with the <i>Contract Documents</i> and the <i>Work</i> is complete, there being no claims for lien registered against the title to the <i>Place of the Work</i> and no written notices of lien delivered to the <i>Owner</i>, pay the <i>Contractor</i> any unpaid balance of the <i>Contract Price</i> in accordance with GC 5.5 – FINAL PAYMENT, excluding <i>Deficiency Holdback</i>, together with such <i>Value Added Taxes</i> as may be applicable to such payment."</p>
SC 4.2	A-5.2.1	<p>Delete subparagraph 5.2.1 in its entirety and <u>replace</u> it with the following:</p> <p>"1.1 Should either party fail to make payments as they become due under the terms of the <i>Contract</i> or in an award by arbitration or court, interest shall also become due and payable on such unpaid amounts at the prejudgment interest rate prescribed by the <i>Courts of Justice Act</i> (Ontario), as it may change from time to time."</p>

**\*NEW\* ARTICLE A-9 – CONFLICT OF INTEREST**

SC3.1	A-9	<p><u>Add</u> new ARTICLE A-9 CONFLICT OF INTEREST as follows:</p> <p><b>"ARTICLE A-9 CONFLICT OF INTEREST</b></p> <p>9.1 The <i>Contractor</i>, <i>Subcontractors</i> and <i>Suppliers</i> and any of their respective advisors, partners, directors, officers, employees, agents, and volunteers shall not engage in any activity or provide any services where such activity or the provision of such services creates a conflict of interest (actually or potentially, in the sole opinion of the <i>Owner</i>) with the provision of the <i>Work</i> pursuant to the <i>Contract</i>. The <i>Contractor</i> acknowledges and agrees that a conflict of interest, as described in this Article A-9, includes, but is not limited to, the use of <i>Confidential Information</i> where the <i>Owner</i> has not specifically authorized such use.</p> <p>9.2 The <i>Contractor</i> shall disclose to the <i>Owner</i>, in writing, without delay, any actual or potential situation that may be reasonably interpreted as either a conflict of interest or a potential conflict of interest, including the retention of any <i>Subcontractor</i> or <i>Supplier</i> that is directly or indirectly affiliated with or related to the <i>Contractor</i>.</p> <p>9.3 The <i>Contractor</i> covenants and agrees that it will not hire or retain the services of any employee or previous employee of the <i>Owner</i> where to do so constitutes a breach by such employee or previous employee of the <i>Owner's</i> conflict of interest policy, as it may be amended from time to time, until after completion of the <i>Work</i> under the <i>Contract</i>.</p> <p>9.4 It is of the essence of the <i>Contract</i> that the <i>Owner</i> shall not have direct or indirect liability to any <i>Subcontractor</i> or <i>Supplier</i>, and that the <i>Owner</i> relies on the maintenance of an arm's-length relationship between the <i>Contractor</i> and its <i>Subcontractors and Suppliers</i>. Consistent with this fundamental term of the <i>Contract</i>, the <i>Contractor</i> will not enter into any agreement</p>
-------	-----	--

		<p>or understanding with any <i>Subcontractor or Supplier</i>, whether as part of any contract or any written or oral collateral agreement, pursuant to which the parties thereto agree to cooperate in the presentation of a claim for payment against the <i>Owner</i>, directly or through the <i>Contractor</i>, where such claim is, in whole or in part, in respect of a disputed claim by the <i>Subcontractor or Supplier</i> against the <i>Contractor</i>, where the payment to the <i>Subcontractor or Supplier</i> by the <i>Contractor</i> is agreed to be conditional or contingent on the ability to recover those amounts or a portion thereof from the <i>Owner</i>, failing which the <i>Contractor</i> shall be saved harmless from all or a portion of those claims. The <i>Contractor</i> acknowledges that any such agreement would undermine the required arm's-length relationship and constitute a conflict of interest. For greater certainty, the <i>Contractor</i> shall only be entitled to advance claims against the <i>Owner</i> for amounts pertaining to <i>Subcontractor or Supplier</i> claims where the <i>Contractor</i> has actually paid or unconditionally acknowledged liability for those claims or where those claims are the subject of litigation or binding arbitration between the <i>Subcontractor or Supplier</i> and the <i>Contractor</i> has been found liable for those claims.</p> <p>9.5 Notwithstanding paragraph 7.1.2 of GC 7.1 - OWNER'S RIGHT TO PERFORM THE WORK, TERMINATE THE CONTRACTOR'S RIGHT TO CONTINUE WITH THE WORK, OR TERMINATE THE CONTRACT, a breach of this Article A-9 by the <i>Contractor</i>, any of the <i>Subcontractors</i>, or any of their respective advisors, partners, directors, officers, employees, agents, and volunteers shall entitle the <i>Owner</i> to terminate the <i>Contract</i>, in addition to any other rights and remedies that the <i>Owner</i> has in the <i>Contract</i>, in law, or in equity."</p>
--	--	--

**\*NEW\* ARTICLE A-10 TIME OF THE ESSENCE**

SC6.1	Article A-10	<p><u>Add</u> the following new Article A-10 as follows:</p> <p><b>"ARTICLE A-10 TIME OF THE ESSENCE</b></p> <p>10.1 It is agreed that one of the reasons the <i>Contractor</i> was selected by the <i>Owner</i> for this <i>Contract</i> is the <i>Contractor's</i> representation and covenant that it will attain <i>Substantial Performance, Occupancy</i> (if applicable), and <i>Ready-for-Takeover</i> within the <i>Contract Time</i> stated in Article A-1 of this <i>Contract</i>.</p> <p>10.2 The <i>Contractor</i> acknowledges and agrees that it is responsible to marshal its resources and those of its <i>Subcontractors and Suppliers</i> in a manner which will permit timely attainment of <i>Substantial Performance, Occupancy</i> (if applicable), and <i>Ready-for-Takeover</i>. The <i>Contractor</i> agrees that time is of the essence of this <i>Contract</i>."</p> <p>10.3 The Contractor shall pay to the Owner compensation for all additional costs and damages borne by the Board to cover costs incurred due to delay beyond contract timelines, until Ready-for-Takeover is achieved and certified pursuant to the terms of the Contract. Liquidated damages will be assessed as incurred and amounts will be payable directly to the Board. Additional costs may include, but are not limited to: temporary classrooms, temporary washrooms, additional staff, etc.</p>
SC6.2		



**DEFINITIONS**

<b>Revisions to Existing Definitions</b>		
SC5.1	Consultant	<p><u>Amend</u> the definition of “Consultant” by <u>adding</u> the following to the end of the definition:</p> <p>“For the purposes of the <i>Contract</i>, the terms “<i>Consultant</i>”, “<i>Architect</i>” and “<i>Engineer</i>” shall be considered synonymous.”</p>
SC5.2	Payment Legislation/Construction Act	<p><u>Delete</u> the Definition of <i>Payment Legislation</i> and replace it with “Construction Act” as follows:</p> <p><b>“Construction Act</b></p> <p><i>Construction Act</i> means the <i>Construction Act</i>, R.S.O. 1990, c. C.30, as amended, including all regulations passed under it that are enforceable as of the date of execution of this <i>Contract</i>. For certainty, the first procurement process for the <i>Project</i> (<i>i.e.</i>, the “improvement” as that term is defined in the <i>Construction Act</i>) commenced on or after October 1, 2019.”</p>
SC5.3	Ready-for-Takeover	<p><u>Amend</u> the Definition of <i>Ready-for-Takeover</i> by deleting all the words after “as verified” and replacing them with “and approved by the <i>Owner</i>.”</p>
<b>New Definitions</b>		
	Adjudication	<p><u>Add</u> the following definition:</p> <p><b>“Adjudication</b></p> <p><i>Adjudication</i> means construction dispute interim adjudication as defined under the <i>Construction Act</i>.”</p>
	Close-Out Documentation	<p><u>Add</u> the following new definition:</p> <p><b>“Close-Out Documentation</b></p> <p><i>Close-Out Documentation</i> has the meaning given to it under GC 5.4.2.”</p>
	Confidential Information	<p><u>Add</u> the following definition:</p> <p><b>“Confidential Information</b></p> <p><i>Confidential Information</i> means all the information or material of the <i>Owner</i> that is of a proprietary or confidential nature, whether it is identified as proprietary or confidential or not, including but not limited to information and material of every kind and description (such as drawings and move-lists) which is communicated to or comes into the possession or control of the <i>Contractor</i> at any time, but <i>Confidential Information</i> shall not include information that:</p> <ol style="list-style-type: none"> <li>.1 is or becomes generally available to the public without fault or breach on the part of the <i>Contractor</i>, including without limitation breach of any duty of confidentiality owed by the <i>Contractor</i> to the <i>Owner</i> or to any third party, but only after that information becomes generally available to the public;</li> <li>.2 the <i>Contractor</i> can demonstrate to have been rightfully obtained by the <i>Contractor</i> from a third party who had the right to transfer or disclose it to the <i>Contractor</i> free of any obligation of confidence;</li> </ol>

		<p>.3 the <i>Contractor</i> can demonstrate to have been rightfully known to or in the possession of the <i>Contractor</i> at the time of disclosure, free of any obligation of confidence; or</p> <p>.4 is independently developed by the <i>Contractor</i> without use of any <i>Confidential Information</i>.”</p>
	Construction Schedule	<p><u>Add</u> the following definition:</p> <p><b>“Construction Schedule</b>  <i>Construction Schedule</i> means the schedule for the performance of the <i>Work</i> provided by the <i>Contractor</i>, and approved by the <i>Owner</i>, pursuant to GC 3.4.1, including any amendments to the <i>Construction Schedule</i> made pursuant to the <i>Contract Documents</i>.”</p>
	Construction Schedule Update	<p><u>Add</u> the following definition:</p> <p><b>“Construction Schedule Update</b>  <i>Construction Schedule Update</i> means an update to the <i>Construction Schedule</i> by the <i>Contractor</i> using Microsoft Project (or other approved scheduling software) that accurately depicts the progress of the <i>Work</i> relative to the critical path established in the <i>Construction Schedule</i> approved in GC 3.5.1 (or any approved successor <i>Construction Schedule</i>), aligns with the currently approved date for <i>Substantial Performance of the Work</i>, shows up-to-date projected major activity sequences and durations, and shows any changes or delays in anticipated completion dates of major activities in the <i>Work</i> relative to the last <i>Construction Schedule Update</i>, and includes the following minimum deliverables:</p> <p>(a) a record version of the updated <i>Construction Schedule</i> in .pdf format;</p> <p>(b) an editable copy of the updated original digital file of the <i>Construction Schedule</i> (e.g., .mpp format files for Microsoft Project).”</p>
	Deficiency Holdback	<p><u>Add</u> the following definition:</p> <p><b>Deficiency Holdback</b> - a value applied to the total contract value to cover the cost of completing deficiencies in, or correcting defects in The Work.</p>
	Direct Costs	<p><u>Add</u> the following definition:</p> <p><b>“Direct Costs</b>  <i>Direct Costs</i> are the reasonable costs of performing the contract or subcontract including costs related to the additional supply of services or materials (including equipment rentals), insurance and surety bond premiums, and costs resulting from seasonal conditions, that would not have been incurred, but do not include indirect damages suffered, such as loss of profit, productivity or opportunity, or any head office overhead costs.”</p>
	EFT	<p><u>Add</u> the following definition:</p> <p><b>“EFT</b></p>

		<i>EFT</i> has the definition given to it under GC 5.3.2.”
	Excess Soil	<u>Add</u> the following definition:  <b>“Excess Soil</b> <i>Excess Soil</i> means “excess soil” as that term is defined under section 3 of the <i>Excess Soil Regulation</i> .”
	Excess Soil Regulation	<u>Add</u> the following Definition:  <b>“Excess Soil Regulation</b> <i>Excess Soil Regulation</i> means O. Reg. 406/19: On-Site and Excess Soil Management to the <i>Environmental Protection Act</i> , R.S.O. 1990, c. E.19.”
	Final Pre-Invoice Submission Meeting	<u>Add</u> the following ne definition:  <b>“Final Pre-Invoice Submission Meeting</b> <i>Final Pre-Invoice Submission Meeting</i> has the meaning given to it in GC 5.5.1.”
	Force Majeure	<u>Add</u> the following definition:  <b>“Force Majeure</b> <i>Force Majeure</i> means any cause, unknown at the effective date of the <i>Contract</i> and beyond either party’s control, other than financial difficulties, bankruptcy or insolvency, which prevents the performance by a party, or both, of any of their respective obligations under the <i>Contract</i> and the event of <i>Force Majeure</i> did not arise from a party’s default and could not be avoided or mitigated by the exercise of reasonable effort or foresight. <i>Force Majeure</i> includes <i>Labour Disputes</i> ; fire; unusual delay by common carriers or unavoidable casualties; delays in obtaining third-party licences, permits, agreements, or approvals (excluding approvals of any <i>Subcontractors</i> or <i>Suppliers</i> of any tier); civil disturbance; emergency acts, orders, legislation, regulations or directives or revoking of funding from any government or other public authority; acts of a public enemy; war; riot; sabotage; blockage; embargo; lightning; earthquake; adverse weather conditions but only if substantially beyond the weather norms of the <i>Place of the Work</i> ; acts of God; or declared epidemic or pandemic outbreak or other public health emergency (e.g. SARS, COVID-19).”
	Install	<u>Add</u> the following definition:  <b>“Install</b> <i>Install</i> means install and connect. <i>Install</i> has this meaning whether or not the first letter is capitalized.”
	Labour Dispute	<u>Add</u> the following definition:  <b>“Labour Dispute</b> <i>Labour Dispute</i> means any lawful or unlawful labour problems, work stoppage, labour disruption, strike, job action, slow down, lock-outs, picketing, refusal to work or continue to work, refusal to supply materials, cessation or work or other labour controversy which does, or might, affect the <i>Work</i> .”

	Notice of Non-Payment	<p><u>Add</u> the following definition:</p> <p><b>“Notice of Non-Payment</b></p> <p><i>Notice of Non-Payment</i> means a notice of non-payment of holdback (Form 6) or a notice of non-payment (Form 1.1) under the Act, as applicable to the circumstances.”</p>
	OHSA	<p><u>Add</u> the following definition:</p> <p><b>“OHSA</b></p> <p><i>OHSA</i> means the <i>Occupational Health and Safety Act</i>, R.S.O. 1990, c. O.1, as amended, including all regulations thereto.”</p>
	Overhead	<p><u>Add</u> the following definition:</p> <p><b>“Overhead</b></p> <p><i>Overhead</i> means all site and head office operations and facilities, all site and head office administration and supervision; all duties and taxes for permits and licenses required by the authorities having jurisdiction at the <i>Place of the Work</i>; all requirements of Division 1, including but not limited to submittals, warranty, quality control, calculations, testing and inspections; meals and accommodations; and, tools, expendables and clean-up costs.”</p>
	Payment Period	<p><u>Add</u> the following definition:</p> <p><b>“Payment Period</b></p> <p><i>Payment Period</i> has the definition given to it under GC 5.2.1.”</p>
	Pre-Invoice Submission Meeting	<p><u>Add</u> the following definition:</p> <p><b>“Pre-Invoice Submission Meeting</b></p> <p><i>Pre-Invoice Submission Meeting</i> has the definition given to it under GC 5.2.1.”</p>
	Proper Invoice	<p><u>Add</u> the following definition:</p> <p><b>“Proper Invoice</b></p> <p><i>Proper Invoice</i> means a “proper invoice” as that term is defined in Section 6.1 of the Act, including the minimum requirements set out in Appendix “1” of the Supplementary Conditions.”</p>
	Proper Invoice Submission Date	<p><u>Add</u> the following definition:</p> <p><b>“Proper Invoice Submission Date</b></p> <p><i>Proper Invoice Submission Date</i> has the definition given to it under GC 5.2.2.1.”</p>
	Request for Information (RFI)	<p><u>Add</u> the following definition:</p> <p><b>“Request for Information (RFI)</b></p> <p><i>Request for Information</i> or <i>RFI</i> means written documentation sent by the <i>Contractor</i> to the <i>Owner</i> or to the <i>Owner’s</i> representative or the <i>Consultant</i> requesting written clarification(s) and/or interpretation(s) of the <i>Drawings</i> and/or <i>Specifications</i>,</p>

		<i>Contract requirements and/or other pertinent information required to complete the Work of the Contract without applying for a change or changes to the Work."</i>
	Restricted Period	<p><u>Add</u> the following definition:</p> <p><b>"Restricted Period</b></p> <p><i>Restricted Period</i> means the (inclusive) period of time between December 1 to January 8 and August 15 to September 15 of any given year throughout the duration of the <i>Contract</i>."</p>

**GENERAL CONDITIONS OF THE STIPULATED PRICE CONTRACT**

Where a General Condition or paragraph of the General Conditions of the *Contract* is deleted by these amendments, the numbering of the remaining General Conditions or paragraphs shall remain unchanged, unless stated otherwise herein, and the numbering of the deleted item will be retained, unused.

**PART 1 GENERAL PROVISIONS**

**GC 1.1 CONTRACT DOCUMENTS**

SC5.1	1.1.3	<p><u>Delete</u> GC 1.1.3 in its entirety and <u>replace</u> it with the following:</p> <p>"1.1.3 The <i>Contractor</i> shall review the <i>Contract Documents</i> and shall report promptly to the <i>Consultant</i> any error, inconsistency, or omission the <i>Contractor</i> may discover. Such review by the <i>Contractor</i> shall be undertaken with the standard of care described in GC 3.13.1. Except for its obligation to make such a review and report the result, the <i>Contractor</i> does not assume any responsibility to the <i>Owner</i> or to the <i>Consultant</i> for the accuracy of the <i>Contract Documents</i>. Provided it has exercised the degree of care and skill described in this GC 1.1.3, the <i>Contractor</i> shall not be liable for damage or costs resulting from such errors, inconsistencies, or omissions in the <i>Contract Documents</i>, which the <i>Contractor</i> could not reasonably have discovered through the exercise of the required standard of care."</p>
SC5.2	1.1.4	<p><u>Delete</u> GC 1.1.4 in its entirety and <u>replace</u> it with the following:</p> <p>"1.1.4 Except for the obligation to complete the review prescribed in GC 1.1.3, and report the results as set out in this GC 1.1.4, the <i>Contractor</i> is not responsible for errors, omissions or inconsistencies in the <i>Contract Documents</i>. If there are errors, omissions or inconsistencies discovered by or made known to the <i>Contractor</i> as part of its review under GC 1.1.3 or at any time during the performance of the <i>Work</i>, the <i>Contractor</i> shall immediately notify the <i>Consultant</i>, and request instructions, a <i>Supplemental Instruction</i>, <i>Change Order</i>, or <i>Change Directive</i>, as the case may require, and shall not proceed with the <i>Work</i> affected until the <i>Contractor</i> has received corrected or additional information from the <i>Consultant</i>. The <i>Contractor</i> shall not be liable for damage or costs resulting from such errors, inconsistencies, or omissions in the <i>Contract Documents</i>, which the <i>Contractor</i> could not reasonably have discovered through the exercise of care and skill described in GC 3.13."</p>
	1.1.5.1	<p><u>Delete</u> GC 1.1.5.1 and <u>replace</u> with the following:</p> <p>".1 the order of priority of documents, from highest to lowest, shall be:</p> <ul style="list-style-type: none"> <li>.1 Supplementary Conditions;</li> <li>.2 the Agreement between the Owner and the Contractor;</li> <li>.3 the Definitions;</li> </ul>

		<p>.4 the General Conditions;</p> <p>.5 Division 01 of the <i>Specifications</i></p> <p>.6 technical <i>Specifications</i>;</p> <p>.7 material and finishing schedules; and</p> <p>.8 the <i>Drawings</i>.</p>
	1.1.5.5	<p><u>Delete</u> GC 1.1.5.5 and <u>replace</u> with the following:</p> <p>“.5 Noted materials and annotations on the <i>Drawings</i> shall govern over the graphic representation of the <i>Drawings</i>.”</p>
	1.1.5.6 to 1.1.5.8	<p><u>Add</u> the following new GC 1.1.5.6 to 1.1.5.8 as follows:</p> <p>“.6 Finishes in the room finish schedules shall govern over those shown on the <i>Drawings</i>.</p> <p>.7 Architectural drawings shall have precedence over structural, plumbing, mechanical, electrical and landscape drawings insofar as outlining, determining and interpreting conflicts over the required design intent of all architectural layouts and architectural elements of construction, it being understood that the integrity and installation of the systems designed by the <i>Consultant</i> or its sub-<i>Consultants</i> are to remain with each of the applicable drawing disciplines.</p> <p>.8 Should reference standards contained in the <i>Specifications</i> conflict with the <i>Specifications</i>, the <i>Specifications</i> shall govern. Should reference standards and <i>Specifications</i> conflict with each other or if certain requirements of the <i>Specifications</i> conflict with other requirements of the <i>Specifications</i>, the more stringent requirements shall govern.”</p>
	1.1.9	<p><u>Add</u> the following to the end of GC 1.1.9:</p> <p>“The <i>Specifications</i> are divided into divisions and sections for convenience but shall be read as a whole and neither such division nor anything else contained in the <i>Contract Documents</i> will be construed to place responsibility on the <i>Owner</i> or the <i>Consultant</i> to settle disputes among the <i>Subcontractors</i> and <i>Suppliers</i> with respect to such divisions. The <i>Drawings</i> are, in part, diagrammatic and are intended to convey the scope of the <i>Work</i> and indicate general and appropriate locations, arrangements and sizes of fixtures, equipment, outlets and other elements. The <i>Contractor</i> shall obtain more accurate information about the locations, arrangements and sizes from study and coordination of the <i>Drawings</i>, including <i>Shop Drawings</i> and shall become familiar with conditions and spaces affecting those matters before proceeding with the <i>Work</i>. Where site conditions require reasonable minor changes where the change requires only the additional labour two hours or less, the <i>Contractor</i> shall make such changes at no additional cost to the <i>Owner</i>. Similarly, where known conditions or existing conditions interfere with new installation and require relocation, the <i>Contractor</i> shall include such relocation in the <i>Work</i>. The <i>Contractor</i> shall arrange and install fixtures and equipment in such a way as to conserve as much headroom and space as possible. The schedules are those portions of the <i>Contract Documents</i>, wherever located and whenever issued, which compile information of similar content and may consist of drawings, tables and/or lists.”</p>
	1.1.13	<p><u>Add</u> new paragraphs 1.1.13 as follows:</p> <p>1.1.13 The <i>Contractor</i> shall keep one copy of the current <i>Contract Documents</i>, <i>Supplemental Instructions</i>, contemplated <i>Change Orders</i>, <i>Change Orders</i>, <i>Change Directives</i>, cash allowance disbursement authorizations, reviewed <i>Shop Drawings</i>, submittals, reports and records of meeting at the <i>Place of the Work</i>, in good order and available to the <i>Owner</i> and <i>Consultant</i>.”</p>

**GC 1.3 RIGHTS AND REMEDIES**

SC6.1	1.3.2	In paragraph 1.3.2 <u>delete</u> the word “No” from the beginning of the paragraph and <u>replace</u> it with the words:  “Except with respect to the requirements set out in paragraphs 6.4.1, 6.5.4, 6.6.1 and 8.3.2, no...”
-------	-------	--

**\*NEW\* GC 1.5 EXAMINATION OF DOCUMENTS AND SITE**

SC8.1	1.5	<u>Add</u> new GC 1.5 – EXAMINATION OF DOCUMENTS AND SITE as follows:  <b>“GC 1.5 EXAMINATION OF DOCUMENTS AND SITE</b>  1.5.1 The <i>Contractor</i> declares and represents that in tendering for the <i>Work</i> , and in entering into a Contract with the <i>Owner</i> for the performance of the <i>Work</i> , it has investigated for itself the character of the <i>Work</i> to be done, based on information generally available from a visit to the <i>Place of the Work</i> and to the standard set out under GC 3.14.1 and further represents and warrants and acknowledges that it considered and took into account in the <i>Contract Price</i> all reasonably known impacts and restrictions arising from the COVID-19 pandemic, including without limitation corresponding legislative changes that may impact performance of the <i>Project</i> , various weather conditions that may affect the <i>Work</i> , the availability of supplies and labour or other conditions or risks that the <i>Contractor</i> knew about or reasonably ought to have known about prior to the date of the <i>Contract</i> . The <i>Contractor</i> has assumed and does hereby assume all risk of known conditions now existing or arising in the course of the <i>Work</i> which might or could make the <i>Work</i> , or any items thereof more expensive in character, more onerous to fulfill than was contemplated or known when the tender was made or the <i>Contract</i> signed.  1.5.2 The <i>Contractor</i> also declares that prior to commencement of the <i>Work</i> , where in tendering for the <i>Work</i> and in entering into this <i>Contract</i> , the <i>Contractor</i> relied upon information furnished by the <i>Owner</i> or any of its agents or servants respecting the nature or confirmation of the ground at the site of the <i>Work</i> , the <i>Contractor</i> shall review to the standard specified in GC 3.14.1, the accuracy of the information furnished by the <i>Owner</i> . If a condition is materially different than what is stated in the information furnished by the <i>Owner</i> , the <i>Contractor</i> shall, no later than five (5) <i>Working Days</i> after the first observation of such condition(s), deliver to the <i>Owner</i> and to the <i>Consultant</i> a <i>Notice in Writing</i> specifying the materially different condition and the <i>Contractor</i> shall not proceed with the affected part of the <i>Work</i> until receiving written direction from the <i>Owner</i> or the <i>Consultant</i> . Where the <i>Contractor</i> fails to provide prompt <i>Notice in Writing</i> in accordance with this GC 1.5.2, the <i>Contractor</i> expressly waives and releases the <i>Owner</i> from all claims with respect to the said information with respect to the <i>Work</i> .
-------	-----	---

**PART 2 ADMINISTRATION OF THE CONTRACT**

**GC 2.2 ROLE OF THE CONSULTANT**

SC11.1	2.2.5	<u>Delete</u> paragraph 2.2.4 and <u>replace</u> it with the following:  “2.2.4 Upon receipt of an application for payment that satisfies the requirement of a <i>Proper Invoice</i> , based on the <i>Consultant's</i> observations and evaluation of the <i>Contractor's</i> application for payment, the <i>Consultant</i> will determine the amounts owing to the <i>Contractor</i> under the <i>Contract</i> and will issue certificates for payment as provided in Article A-5 - PAYMENT, GC 5.3 - PAYMENT, GC 5.4 SUBSTANTIAL PERFORMANCE OF THE WORK
--------	-------	--

		AND PAYMENT OF HOLDBACK, and GC 5.5 - FINAL PAYMENT. If the <i>Consultant</i> determines that the amount payable to the <i>Contractor</i> differs from the amount stated in a <i>Proper Invoice</i> , the <i>Consultant</i> shall notify the <i>Owner</i> as provided in GC 5.3.1.2 and prepare a draft of the applicable <i>Notice of Non-Payment</i> for the amount in dispute.”
	2.2.6	In the first sentence of paragraph 2.2.6, <u>delete</u> the words “Except with respect to GC 5.1 – FINANCING INFORMATION REQUIRED OF THE OWNER”.
	2.2.12	At paragraph 2.2.12, <u>insert</u> the following at end of that paragraph:  “If, in the opinion of the <i>Contractor</i> , the <i>Supplemental Instruction</i> involves an adjustment in the <i>Contract Price</i> or in the <i>Contract Time</i> , it shall, within ten (10) <i>Working Days</i> of receipt of a <i>Supplemental Instruction</i> , provide the <i>Consultant</i> with a notice in writing to that effect. Failure to provide written notification within the time stipulated in this paragraph 2.2.12 shall be deemed an acceptance of the <i>Supplemental Instruction</i> by the <i>Contractor</i> , without any adjustment in the <i>Contract Price</i> or <i>Contract Time</i> .”

**GC 2.3 REVIEW AND INSPECTION OF THE WORK**

SC10.1	2.3.2	<u>Amend</u> paragraph 2.3.2 by <u>adding</u> the words “and <i>Owner</i> ” after the words “ <i>Consultant</i> ” in the second and third lines.
	2.3.3	<u>Delete</u> paragraph 2.3.3 in its entirety and <u>replace</u> it with the following:  “2.3.3 The <i>Contractor</i> shall furnish promptly two copies to the <i>Consultant</i> and one copy to the <i>Owner</i> of all certificates and inspection reports relating to the <i>Work</i> .”
	2.3.4	In paragraph 2.3.4 <u>add</u> the word “review” after the word “inspections” in the first and second lines of paragraph 2.3.4.
	2.3.5	In paragraph 2.3.5 in the first line after the word “ <i>Consultant</i> ”, <u>add</u> “or the <i>Owner</i> ”.
	2.3.8	<u>Add</u> a new paragraph 2.3.8 as follows:  “2.3.8 The <i>Consultant</i> will conduct periodic reviews of the <i>Work</i> in progress, to determine general conformance with the requirements of the <i>Contract Documents</i> . Such reviews, or lack thereof, shall not give rise to any claims by the <i>Contractor</i> in connection with construction means, methods, techniques, sequences and procedures, nor in connection with construction safety at the <i>Place of Work</i> , responsibility for which belongs exclusively to the <i>Contractor</i> .”

**GC 2.4 DEFECTIVE WORK**

SC11.1	2.4.1	<u>Amend</u> GC 2.4.1 by inserting “, the <i>Owner</i> and/or its agent” in the first sentence following “rejected by the <i>Consultant</i> ”.
	2.4.1.1 to 2.4.1.2	<u>Add</u> new paragraphs 2.4.1.1 and 2.4.1.2 as follows:  “2.4.1.1 The <i>Contractor</i> shall rectify, in a manner acceptable to the <i>Consultant</i> and to the <i>Owner through the Consultant</i> all defective work and deficiencies throughout the <i>Work</i> , whether or not they are specifically identified by the <i>Consultant</i> .  2.4.1.2 The <i>Contractor</i> shall prioritize the correction of any defective work, which, in the sole discretion of the <i>Owner through the Consultant</i> , adversely affects the day to day operations



		of the <i>Owner</i> or which, in the sole discretion of the <i>Consultant</i> , adversely affects the progress of the <i>Work</i> .”
	2.4.2	<u>Delete</u> paragraph 2.4.2 in its entirety and <u>replace</u> it with the following:  “2.4.2 The <i>Contractor</i> shall promptly pay the <i>Owner</i> for costs incurred by the <i>Owner</i> , the <i>Owner’s</i> own forces or the <i>Owner’s</i> other contractors, for work destroyed or damaged or any alterations necessitated by the <i>Contractor’s</i> removal, replacement or re-execution of defective work.”
	2.4.4	<u>Add</u> new paragraph 2.4.4 as follows:  “2.4.4 Neither acceptance of the <i>Work</i> by the <i>Consultant</i> or the <i>Owner</i> , nor any failure by the <i>Consultant</i> or the <i>Owner</i> to identify, observe or warn of defective <i>Work</i> or any deficiency in the <i>Work</i> shall relieve the <i>Contractor</i> from the sole responsibility for rectifying such defect or deficiency at the <i>Contractor’s</i> sole cost, even where such failure to identify, observe or warn is negligent.”

**PART 3 EXECUTION OF THE WORK**

**GC 3.1 CONTROL OF THE WORK**

SC12.1	3.1.2	Amend paragraph 3.1.2 by <u>inserting</u> the words “Construction Schedule” after the word “sequences”.
SC12.2	3.1.3 & 3.1.4	<u>Add</u> new paragraphs 3.1.3 and 3.1.4 as follows:  “3.1.3 Prior to commencing individual procurement, fabrication and construction activities, the <i>Contractor</i> shall verify at the <i>Place of the Work</i> , all relevant measurements and levels necessary for proper and complete fabrication, assembly and installation of the <i>Work</i> and shall further carefully compare such field measurements and conditions with the requirements of the <i>Contract Documents</i> . Where dimensions are not included or exact locations are not apparent, the <i>Contractor</i> shall immediately notify the <i>Consultant</i> in writing and obtain written instructions from the <i>Consultant</i> before proceedings with any part of the affected <i>Work</i> .  3.1.4 Notwithstanding the provisions of paragraphs 3.1.1 and 3.1.2, the <i>Owner</i> shall have access to the site at all times to monitor all aspects of construction. Such access shall in no circumstances affect the obligations of the <i>Contractor</i> to fulfill its contractual obligations.”

**GC 3.2 CONSTRUCTION BY OWNER OR OTHER CONTRACTORS**

SC13.1	3.2.2.1	<u>Delete</u> subparagraph 3.2.2.1 and <u>replace</u> it with “[Intentionally left blank]”.
	3.2.3.2	<u>Delete</u> subparagraph 3.2.3.2 and <u>replace</u> it with the following:  “.2 co-ordinate and schedule the activities and work of other contractors and the <i>Owner’s</i> own forces, including where other contractors or the <i>Owner’s</i> own forces are used after the <i>Owner</i> and the <i>Contractor</i> cannot reach agreement on the value of a change, with the <i>Work</i> of the <i>Contractor</i> and connect as specified or shown in the <i>Contract Documents</i> .”
	3.2.3.4	<u>Delete</u> the period at the end of subparagraph 3.2.3.4 and <u>replace</u> it with a semicolon.
	3.2.3.5	<u>Add</u> new subparagraph 3.2.3.5 as follows:

		<p>“5 Subject to GC 9.4 CONSTRUCTION SAFETY, for the <i>Owner’s</i> own forces and for other contractors, assume overall responsibility for compliance with all aspects of the applicable health and safety legislation in force at the <i>Place of the Work</i>, including all of the responsibilities of the “constructor”, pursuant to the <i>OHSA</i>.”</p>
--	--	---

**GC 3.3 TEMPORARY WORK**

SC14.1	3.3.2	<p>In paragraph 3.3.2, in the second line after the words “where required by law”, insert “or by the <i>Consultant</i>”.</p>
--------	-------	--

**GC 3.4 CONSTRUCTION SCHEDULE**

SC17.1	3.4.1	<p><u>Delete</u> GC 3.4.1 in its entirety and <u>replace</u> it with the following:</p> <p>“3.4.1 The <i>Contractor</i> shall:</p> <ol style="list-style-type: none"> <li>1 within five (5) calendar days of receiving written confirmation of the award of the <i>Contract</i>, prepare and submit to the <i>Owner</i> and the <i>Consultant</i> for their review and approval, a construction schedule in the format indicated below that indicates the timing of the activities of the <i>Work</i> and provides sufficient detail of the critical events and their inter-relationship to demonstrate the <i>Work</i> will be performed in conformity with the <i>Contract Time</i> and in accordance with the <i>Contract Documents</i>. Such schedule is to include a delivery schedule for <i>Products</i> whose delivery is critical to the schedule for the <i>Work</i> or are required by the <i>Contract</i> to be included in a <i>Products</i> delivery schedule. The <i>Contractor</i> shall employ construction scheduling software, being the latest version of “Microsoft Project”, that permits the progress of the <i>Work</i> to be monitored in relation to the critical path established in the schedule. The <i>Contractor</i> shall provide such schedule and any successor or revised schedules in both original digital file format (e.g., .mpp format for Microsoft Project), portable data file (PDF) format, and hard copy. Once accepted by the <i>Owner</i> and the <i>Consultant</i>, the construction schedule submitted by the <i>Contractor</i> shall become the baseline “<b>Construction Schedule</b>”;</li> <li>.2 provide the expertise and resources, such resources including manpower equipment and tools, as are necessary on a best efforts basis to maintain progress under the accepted baseline <i>Construction Schedule</i> or revised construction schedule accepted by the <i>Owner</i> pursuant to GC 3.4 CONSTRUCTION SCHEDULE, which includes without limitation, the <i>Contractor’s</i> use of all possible and, if necessary, extraordinary measures, to bring the progress of the <i>Work</i> into compliance with the <i>Construction Schedule</i>, such as (i) increasing the presence of its own forces at the <i>Place of the Work</i>; (ii) directing any <i>Subcontractors</i> or <i>Suppliers</i> to increase their labour forces and equipment; (iii) working overtime and extra shifts; and (iv) providing any additional supervision and coordination of the <i>Project</i>, all at the <i>Contractor’s</i> own cost and expense save and except where GC 6.5.1, 6.5.2, or 6.5.3 apply; and,</li> <li>.3 monitor the progress of the <i>Work</i> on a weekly basis relative to the baseline <i>Construction Schedule</i>, or any revised <i>Construction Schedule</i> accepted by the <i>Owner</i> pursuant to GC 3.4 CONSTRUCTION SCHEDULE, deliver a <i>Construction Schedule Update</i> to the <i>Consultant</i> and <i>Owner</i> with each application for payment, at a minimum, or as may be reasonably required</li> </ol>
--------	-------	--

		<p>by the <i>Consultant</i> and advise the <i>Consultant</i> and the <i>Owner</i> weekly in writing of any variation from the baseline or slippage in the schedule; and,</p> <p>.4 if after applying the expertise and resources required under paragraph 3.4.1.2, the <i>Contractor</i> forms the opinion that the slippage in schedule reported in paragraph 3.4.1.3 cannot be recovered by the <i>Contractor</i>, it shall, in the same notice provided under paragraph 3.4.1.3, indicate to the <i>Consultant</i> if the <i>Contractor</i> intends to apply for an extension of <i>Contract Time</i> as provided in PART 6 —CHANGES IN THE WORK; and,</p> <p>.5 ensure that the <i>Contract Price</i> shall include all costs required to phase or stage the <i>Work</i>.”</p>
	3.4.2	<p><u>Add</u> new GC 3.4.2 and GC 3.4.3 as follows:</p> <p>“3.4.2 If, at any time, it should appear to the <i>Owner</i> or the <i>Consultant</i> that the actual progress of the <i>Work</i> is behind schedule or is likely to become behind schedule, or if the <i>Contractor</i> has given notice of such to the <i>Owner</i> or the <i>Consultant</i> pursuant to GC 3.4.1.3, the <i>Contractor</i> shall, either at the request of the <i>Owner</i> or the <i>Consultant</i>, or following giving notice pursuant to GC 3.4.1.3, take appropriate steps to cause the actual progress of the <i>Work</i> to conform to the schedule or minimize the resulting delay. Within 5 calendar days of the request by the <i>Owner</i> or the <i>Consultant</i> or the notice being given pursuant to GC 3.4.1.3, the <i>Contractor</i> shall produce and present to the <i>Owner</i> and the <i>Consultant</i> a plan demonstrating how the <i>Contractor</i> will recover the performance of the <i>Work</i> to align with the currently approved <i>Construction Schedule</i>.</p> <p>3.4.3 The <i>Contractor</i> shall not amend the <i>Construction Schedule</i> without the prior written consent of the <i>Owner</i>.. Any revisions to the <i>Construction Schedule</i> approved by the <i>Owner</i> shall not be deemed to be an extension of the <i>Contract Time</i>. All requests by the <i>Contractor</i> for a revision to the <i>Construction Schedule</i> that include an extension to the <i>Contract Time</i> must be approved by the <i>Owner</i> through an executed <i>Change Order</i>.”</p>

**GC 3.5 SUPERVISION**

SC17.1	3.5.1	<p><u>Delete</u> GC 3.5.1 and <u>replace</u> it with the following:</p> <p>“3.5.1 The <i>Contractor</i> shall employ a competent full-time superintendent, acceptable to the <i>Owner</i> and <i>Consultant</i>, who shall be in full time attendance at the <i>Place of the Work</i> while the <i>Work</i> is being performed. The superintendent shall not be changed by the <i>Contractor</i> without valid reason which shall be provided in writing and shall not be changed without prior consultation with and agreement by the <i>Owner</i> and the <i>Consultant</i>. The <i>Contractor</i> shall replace the superintendent within 7 <i>Working Days</i> of the <i>Owner’s</i> written notification, if the superintendent’s performance is not acceptable to the <i>Owner</i>. The <i>Contractor</i> shall provide the <i>Owner</i> and the <i>Consultant</i> with the names, addresses and telephone numbers of the superintendent referred to in this GC 3.5.1 and other responsible persons who may be contacted for emergency and other reasons during non-working hours. .”</p>
--------	-------	---

	3.5.2	<p><u>Delete</u> GC 3.5.2 and <u>replace</u> it with the following:</p> <p>“3.5.2 The superintendent, and any project manager appointed by the <i>Contractor</i>, shall represent the <i>Contractor</i> at the <i>Place of the Work</i> and shall have full authority to act on written instructions given by the <i>Consultant</i> and/or the <i>Owner</i>. Instructions given to the superintendent or the project manager shall be deemed to have been given to the <i>Contractor</i> and both the superintendent and any project manager shall have full authority to act on behalf of the <i>Contractor</i> and bind the <i>Contractor</i> in matters related to the <i>Contract</i>.”</p>
	3.5.3 to 3.5.6	<p><u>Add</u> new GC 3.5.3, 3.5.4, 3.5.5 and 3.5.6 as follows:</p> <p>“3.5.3 The <i>Owner</i> may, at any time during the course of the <i>Work</i>, request the replacement of the appointed representative(s). Immediately upon receipt of the request, the <i>Contractor</i> shall make arrangements to appoint an acceptable replacement, which is approved by the <i>Owner</i>.</p> <p>3.5.4 The supervisory staff assigned to the <i>Project</i> shall also be fully competent to implement efficiently all requirements for scheduling, coordination, field engineering, reviews, inspections and submittals defined in the <i>Specifications</i>, and have a minimum 5 years documented “Superintendent/Project Management” experience.</p> <p>3.5.5 The <i>Consultant and Owner</i> shall reserve the right to review the record of experience and credentials of supervisory staff assigned to the <i>Project</i> prior to commencement of the <i>Work</i>.</p> <p>3.5.6 A superintendent assigned to the <i>Work</i> shall be “Gold Seal Certified” as per the Canadian Construction Association; or a superintendent that can demonstrate the requisite experience and success related to the <i>Project</i> to the sole satisfaction of the <i>Owner</i>.”</p>

**GC 3.6 SUBCONTRACTORS AND SUPPLIERS**

SC18.1	3.6.1.1	<p>In paragraph 3.6.1.1 <u>add</u> to the end of the second line the words “including any warranties and service agreements which extend beyond the term of the <i>Contract</i>.”</p>
	3.6.1.2	<p>In subparagraph 3.6.1.2 after the words “the <i>Contract Documents</i>” <u>add</u> the words “including any required surety bonding”.</p>
	3.6.2	<p><u>Delete</u> paragraph 3.6.2. in its entirety and <u>replace</u> it with the following:</p> <p>“3.6.2 The substitution of any <i>Subcontractor</i> and/or <i>Suppliers</i> after submission of the <i>Contractor’s</i> bid will not be accepted unless a valid reason is given in writing to and approved by the <i>Owner</i>, whose approval may be arbitrarily withheld. The reason for substitution must be provided to the <i>Owner</i> and to the original <i>Subcontractor</i> and/or <i>Supplier</i> and the <i>Subcontractor</i> and/or <i>Supplier</i> shall be given the opportunity to reply to the <i>Contractor</i> and <i>Owner</i>. The <i>Contractor</i> shall be fully aware of the capability of each <i>Subcontractor</i> and/or <i>Supplier</i> included in its bid, including but not limited to technical ability, financial stability and ability to maintain the proposed construction schedule.”</p>
	3.6.7, 3.6.8,	<p><u>Add</u> new paragraphs 3.6.7, 3.6.8, 3.6.9, and 3.6.10 as follows:</p>

3.6.9 & 3.6.10		<p>“3.6.7 The <i>Contractor</i> represents and warrants that it has confirmed the availability of its <i>Subcontractors</i> for the <i>Project</i> and, in particular, for the performance of their respective portions of the <i>Work</i> to ensure completion of the <i>Project</i> within the <i>Contract Price</i> and the <i>Contract Time</i>.</p> <p>3.6.8 The <i>Consultant</i> or the <i>Owner</i>, acting reasonably, may from time to time require the <i>Contractor</i> to remove from the <i>Project</i> any personnel of the <i>Contractor</i>, including project managers, superintendents or <i>Subcontractors</i>. Such persons shall be replaced by the <i>Contractor</i> in a timely fashion to the satisfaction of the <i>Consultant</i> or the <i>Owner</i>, as the case may be, at no cost to the <i>Owner</i>.</p> <p>3.6.9 Where provided in the <i>Contract</i>, the <i>Owner</i> may assign to the <i>Contractor</i>, and the <i>Contractor</i> agrees to accept, any contract procured by the <i>Owner</i> for <i>Work</i> or services required on the <i>Project</i> that has been pre-tendered or pre-negotiated by the <i>Owner</i>, and upon such assignment, the <i>Owner</i> shall have no further liability to any party for such contract.</p> <p>3.6.10 The <i>Contractor</i> covenants that each subcontract or supply contract which the <i>Contractor</i> enters into for the purpose of performing the <i>Work</i> shall expressly provide for the assignment thereof to the <i>Owner</i> (at the option of the <i>Owner</i>) and the assumption by the <i>Owner</i> of the obligations of the <i>Contractor</i> thereunder, upon the termination of the <i>Contract</i> and upon written notice by the <i>Owner</i> to the other parties to such subcontracts or supply contracts, without the imposition of further terms or conditions; provided, however, that until the <i>Owner</i> has given such notice, nothing herein contained shall be deemed to create any contractual or other liability upon the <i>Owner</i> for the performance of obligations under such subcontracts or supply contracts and the <i>Contractor</i> shall be fully responsible for all of its obligations and liabilities (if any) under such subcontracts and supply contracts.”</p>
----------------	--	---

**GC 3.7 LABOUR AND PRODUCTS**

SC19.1	3.7.1	<u>Amend</u> paragraph 3.7.1 by <u>adding</u> the words, “..., agents, <i>Subcontractors</i> and <i>Suppliers</i> ...” after the word “employees” in the first line.
SC19.2	3.7.2	<p><u>Delete</u> paragraph 3.7.2 and <u>substitute</u> with the following:</p> <p>“3.7.2 <i>Products</i> provided shall be new and shall conform to all current applicable specifications of the Canadian Standards Association, Canadian Standards Board or General Standards Board, ASTM, National Building Code, provincial and municipal building codes, fire safety standards, and all governmental authorities and regulatory agencies having jurisdiction at the <i>Place of the Work</i>, unless otherwise specified. <i>Products</i> which are not specified shall be of a quality consistent with those specified and their use acceptable to the <i>Consultant</i>. <i>Products</i> brought on to the <i>Place of the Work</i> by the <i>Contractor</i> shall be deemed to be the property of the <i>Owner</i>, but the <i>Owner</i> shall be under no liability for loss thereof or damage thereto arising from any cause whatsoever. The said <i>Products</i> shall be at the sole risk of the <i>Contractor</i>. Workmanship shall be, in every respect, first class and the <i>Work</i> shall be performed in accordance with the best modern industry practice.”</p>
	3.7.4 to 3.7.8	<p><u>Add</u> new paragraphs 3.7.4, 3.7.5, 3.7.6, 3.7.7, and 3.7.8 as follows:</p> <p>“3.7.4 Upon receipt of a <i>Notice in Writing</i> from the <i>Owner</i>, the <i>Contractor</i> shall immediately remove from the <i>Place of the Work</i>, tradesmen and labourers or anyone whose conduct</p>

		<p>jeopardizes the safety of the <i>Owner's</i> operations or who are considered by the <i>Owner</i> or the <i>Consultant</i> to be unskilled or otherwise objectionable. Immediately upon receipt of the request, the <i>Contractor</i> shall make arrangements to appoint an acceptable replacement.</p> <p>3.7.5 The <i>Contractor</i> shall cooperate with the <i>Owner</i> and its representatives and shall take all reasonable and necessary actions to maintain stable and harmonious labour relations with respect to the <i>Work</i> at the <i>Place of the Work</i>, including cooperation to attempt to avoid <i>Work</i> stoppages, trade union jurisdictional disputes and other <i>Labour Disputes</i>. Any costs arising from labour disputes shall be at the sole expense of the <i>Contractor</i>.</p> <p>3.7.6 The cost for overtime required beyond the normal <i>Working Day</i> to complete individual construction operations of a continuous nature, such as pouring or finishing of concrete or similar work, or <i>Work</i> that the <i>Contractor</i> elects to perform at overtime rates without the <i>Owner</i> requesting it, shall not be chargeable to the <i>Owner</i>.</p> <p>3.7.7 All manufactured <i>Products</i> which are identified by their proprietary names or by part or catalogue number in the <i>Specifications</i> shall be used by the <i>Contractor</i>. No substitutes for such specified <i>Products</i> shall be used without the written approval of the <i>Owner</i> and the <i>Consultant</i>. Substitutes will only be considered by the <i>Consultant</i> when submitted in sufficient time to permit proper review and investigation. When requesting approval for the use of substitutes, the <i>Contractor</i> shall include in its submission any proposed change in the <i>Contract Price</i>. The <i>Contractor</i> shall use all proprietary <i>Products</i> in strict accordance with the manufacturer's directions. Where there is a choice of proprietary <i>Products</i> specified for one use, the <i>Contractor</i> may select any one of the <i>Products</i> so specified for this use.</p> <p>3.7.8 Materials, appliances, equipment and other <i>Products</i> are sometimes specified by reference to brand names, proprietary names, trademarks or symbols. In such cases, the name of a manufacturer, distributor, <i>Supplier</i> or dealer is sometimes given to assist the <i>Contractor</i> to find a source <i>Supplier</i>. This shall not relieve the <i>Contractor</i> from its responsibility from finding its own source of supply even if the source names no longer supplies the <i>Product</i> specified. If the <i>Contractor</i> is unable to obtain the specified <i>Product</i>, the <i>Contractor</i> shall supply a substitute product equal to or better than the specified <i>Product</i>, as approved by the <i>Consultant</i> with no extra compensation. Should the <i>Contractor</i> be unable to obtain a substitute <i>Product</i> equal to or superior to the specified <i>Product</i> and the <i>Owner</i> accepts a different <i>Product</i>, the <i>Contract Price</i> shall be adjusted accordingly, as approved by the <i>Consultant</i>."</p>
--	--	--

**GC 3.8 SHOP DRAWINGS**

SC21.1	3.8.1	<p><u>Delete</u> paragraph 3.8.1 in its entirety and <u>replace</u> with the following:</p> <p>"3.8.1 The <i>Contractor</i> shall provide shop drawings as described in the <i>Contract Documents</i> and as the <i>Consultant</i> may reasonably request."</p>
	3.8.3	<p><u>Delete</u> paragraph 3.8.3 and <u>replace</u> it with the following:</p> <p>"3.8.3 The <i>Contractor</i> shall prepare a <i>Shop Drawings</i> schedule acceptable to the <i>Owner</i> and the <i>Consultant</i> prior to the first application for payment. A draft of the proposed <i>Shop</i></p>

		<i>Drawings schedule shall be submitted by the Contractor to the Consultant and the Owner for approval. The draft Shop Drawings schedule shall clearly indicate the phasing of Shop Drawings submissions. The Contractor shall periodically re-submit the Shop Drawings schedule to correspond to changes in the Construction Schedule."</i>
	3.8.5	<u>Delete</u> paragraph 3.8.5 in its entirety and <u>substitute</u> the following:  "3.8.5 At the time of providing <i>Shop Drawings</i> , the <i>Contractor</i> shall advise the <i>Consultant</i> in writing of any deviations in <i>Shop Drawings</i> from the requirements of the <i>Contract Documents</i> . The <i>Consultant</i> shall indicate the acceptance of such deviation expressly in writing. Where manufacturers' literature is submitted in lieu of scaled drawings, it shall be clearly marked in ink, to indicate the specific items for which review is requested."
	3.8.8 to 3.8.12	<u>Add</u> new paragraphs 3.8.8, 3.8.9, 3.8.10, 3.8.11, and 3.8.12 as follows:  "3.8.8 Reviewed <i>Shop Drawings</i> shall not authorize a change in the <i>Contract Price</i> and/or the <i>Contract Time</i> .  3.8.9 Except where the parties have agreed to a different <i>Shop Drawings</i> schedule pursuant to paragraph 3.10.3, the <i>Contractor</i> shall comply with the requirements for <i>Shop Drawings</i> submissions stated in the <i>Specifications</i> .  3.8.10 The <i>Contractor</i> shall not use the term "by others" on <i>Shop Drawings</i> or other submittals. The related trade, <i>Subcontractor</i> or <i>Supplier</i> shall be stated.  3.8.11 Certain <i>Specifications</i> sections require the <i>Shop Drawings</i> to bear the seal and signature of a professional engineer. Such professional engineer must be registered in the jurisdiction of the <i>Place of the Work</i> and shall have expertise in the area of practice reflected in the <i>Shop Drawings</i> .  3.8.12 The <i>Consultant</i> will review and return <i>Shop Drawings</i> and submittals in accordance with the schedule agreed upon in paragraph 3.10.3, The <i>Contractor</i> shall allow the <i>Consultant</i> a minimum of 10 <i>Working Days</i> to review <i>Shop Drawings</i> from the date of receipt. If resubmission of <i>Shop Drawings</i> is required, a further 10 <i>Working Day</i> period is required for the <i>Consultant's</i> review."

**\*NEW\* GC 3.9 USE OF THE WORK**

SC22.1	GC 3.9	<u>Add</u> new GC 3.9 – USE OF THE WORK as follows:  <b>"GC 3.9 USE OF THE WORK</b>  3.9.1 The <i>Contractor</i> shall confine <i>Construction Equipment</i> , <i>Temporary Work</i> , storage of <i>Products</i> , waste products and debris, and operations of employees and <i>Subcontractors</i> to limits indicated by laws, ordinances, permits, by the direction of the <i>Owner</i> or the <i>Consultant</i> , or the <i>Contract Documents</i> and shall not unreasonably encumber the <i>Place of the Work</i> .
--------	--------	--

		<p>3.9.2 The <i>Contractor</i> shall not load or permit to be loaded any part of the <i>Work</i> with a weight or force that will endanger the safety of the <i>Work</i>.</p> <p>3.9.3 The <i>Owner</i> shall have the right to enter or occupy the <i>Place of the Work</i> in whole or in part for the purpose of placing fittings and equipment, or for other use before <i>Substantial Performance of the Work</i>, if, in the opinion of the <i>Consultant</i>, such entry and occupation does not prevent or substantially interfere with the <i>Contractor</i> in the performance of the <i>Contract</i> within the <i>Contract Time</i>. Such entry or occupation shall neither be considered as acceptance of the <i>Work</i> or in any way relieves the <i>Contractor</i> from its responsibility to complete the <i>Contract</i>.”</p>
--	--	---

“

**\*NEW\* GC 3.10 CUTTING AND REMEDIAL WORK**

SC23.1	GC 3.10	<p><u>Add</u> new GC 3.10 – CUTTING AND REMEDIAL WORK as follows:</p> <p><b>“GC 3.10 CUTTING AND REMEDIAL WORK</b></p> <p>3.10.1 The <i>Contractor</i> shall perform the cutting and remedial work required to make the affected parts of the <i>Work</i> come together properly. Such cutting and remedial work shall be performed by specialists familiar with the <i>Products</i> affected and shall be performed in a manner to neither damage nor endanger the <i>Work</i>.</p> <p>3.10.2 The <i>Contractor</i> shall coordinate the <i>Work</i> to ensure all cutting and remedial work required is kept to a minimum.</p> <p>3.10.3 Unless specifically stated otherwise in the <i>Specifications</i>, the <i>Contractor</i> shall do all cutting and making good necessary for the proper installation and performance of the <i>Work</i>.</p> <p>3.10.4 To avoid unnecessary cutting, the <i>Contractor</i> shall lay out its work and advise the <i>Subcontractors</i>, when necessary, where to leave holes for installation of pipes and other work.”</p>
--------	---------	---

**\*NEW\* GC 3.11 CLEAN UP**

SC24.1	3.11.1, 3.11.2, 3.11.3, 3.11.4, 3.11.5 & 3.11.6	<p>Add new paragraphs 3.11.1, 3.11.2, 3.11.3, 3.11.4, 3.11.5, and 3.11.6 as follows:</p> <p>“3.11.1 The <i>Contractor</i> shall maintain the <i>Work</i> in a safe and tidy condition and free from the accumulation of waste products and debris, other than that caused by the <i>Owner</i>, other contractors or their employees. The <i>Contractor</i> shall remove accumulated waste and debris at least once a week as a minimum or as required by the nature of the <i>Work</i>.</p> <p>3.11.2 Before applying for <i>Substantial Performance of the Work</i>, the <i>Contractor</i> shall remove waste products and debris, other than that resulting from the work of the <i>Owner</i>, other contractors or their employees, and shall leave the <i>Place of the Work</i> clean and suitable for use or occupancy by the <i>Owner</i>. The <i>Contractor</i> shall remove products, tools, materials,</p>
--------	--	---



		<p><i>Construction Equipment</i>, and <i>Temporary Work</i> not required for the performance of the remaining work.</p> <p>3.11.3 As a condition precedent to submitting its application for final payment, the <i>Contractor</i> shall remove any remaining products, tools, materials, <i>Construction Equipment</i>, <i>Temporary Work</i>, and waste products and debris, other than those resulting from the work of the <i>Owner</i>, other contractors or their employees.</p> <p>3.11.4 The <i>Contractor</i> shall clean up garbage during and after construction and maintain the <i>Place of the Work</i> in a neat and orderly condition on a daily basis. Prior to leaving the <i>Place of the Work</i> and following completion of the <i>Work</i>, the <i>Contractor</i> shall make good all damage to the building and its components caused by the performance of the <i>Work</i> or by any <i>Subcontractor</i> or <i>Supplier</i>. The <i>Contractor</i> shall leave the <i>Place of the Work</i> in a clean and finished state; remove all <i>Construction Equipment</i> and materials; remove all paint, stains, labels, dirt, etc. from the <i>Place of the Work</i>; and touch up all damaged painted areas (if applicable). The <i>Contractor</i> shall be responsible for restoring those areas of the <i>Place of the Work</i>, impacted by the <i>Work</i>, to their original condition.”</p> <p>3.11.5 Without limitation to or waiver of the <i>Owner’s</i> other rights and remedies, the <i>Owner</i> shall have the right to back charge to the <i>Contractor</i> the cost of damage to the site caused by transportation in and out of the <i>Place of the Work</i> by the <i>Contractor</i>, <i>Subcontractors</i> or <i>Suppliers</i>, if not repaired before final payment.</p> <p>3.11.6 The <i>Contractor</i> shall dispose of debris at a location and in a manner acceptable to the <i>Owner</i> (and to the authorities having jurisdiction at the <i>Place of the Work</i> and at the disposal area) and the <i>Contractor</i> shall cover containers with tarpaulins.”</p>
--	--	---

**\*NEW\* GC 3.12 EXCESS SOIL MANAGEMENT**

SC25.1	GC 3.12	<p><u>Add</u> new GC 3.12 – EXCESS SOIL MANAGEMENT as follows:</p> <p><b>“GC 3.12 EXCESS SOIL MANAGEMENT</b></p> <p>3.12.1 The <i>Contractor</i> shall be solely responsible for the proper management of all <i>Excess Soil</i> at the <i>Place of the Work</i> and for performance of the <i>Work</i> in compliance with the rules, regulations and practices required by the <i>Excess Soil Regulation</i> until such time as <i>Ready-for-Takeover</i> is achieved. Without restricting the generality of the previous sentence, the <i>Contractor’s</i> responsibility under this GC 3.12 includes the designation, transportation, tracking, temporary and/or final placement, record keeping, and reporting of all <i>Excess Soil</i> in connection with the <i>Work</i> all in compliance with the <i>Excess Soil Regulation</i>.</p> <p>3.12.3 The <i>Contractor</i> shall indemnify and save harmless the <i>Owner</i>, their agents, officers, directors, administrators, employees, consultants, successors and assigns from and against the consequences of any and all health and safety infractions committed directly by the <i>Contractor</i>, or those for whom it is responsible at law, under the <i>Excess Soil Regulation</i>, or any environmental protection legislation, including the payment of legal fees and disbursements on a substantial indemnity basis. Such indemnity shall apply to the extent</p>
--------	---------	--

		to which the <i>Owner</i> is not covered by insurance.”
--	--	---

**\*NEW\* GC 3.13 CONTRACTOR STANDARD OF CARE**

SC25.1	3.13	<p><u>Add</u> a new GC 3.13 – CONTRACTOR STANDARD OF CARE as follows:</p> <p><b>“GC 3.13 CONTRACTOR STANDARD OF CARE</b></p> <p>“3.13.1 In performing its services and obligations under the <i>Contract</i>, the <i>Contractor</i> shall exercise the standard of care, skill and diligence that would normally be provided by an experienced and prudent contractor supplying similar services for similar projects. The <i>Contractor</i> acknowledges and agrees that throughout the <i>Contract</i>, the performance of the <i>Contractor’s</i> obligations, duties and responsibilities shall be interpreted in accordance with this standard. The <i>Contractor</i> shall exercise the same standard of care, skill and diligence in respect of any <i>Products</i>, personnel or procedures which it may recommend to the <i>Owner</i> or employ on the <i>Project</i>.</p> <p>3.13.2 The <i>Contractor</i> further represents, covenants and warrants to the <i>Owner</i> that:</p> <ol style="list-style-type: none"> <li>.1 the personnel it assigns to the <i>Project</i> are appropriately experienced;</li> <li>.2 it has a sufficient staff of qualified and competent personnel to replace any of its appointed representatives, subject to the <i>Owner’s</i> approval, in the event of death, incapacity, removal or resignation; and</li> <li>.3 there are no pending, threatened or anticipated claims, liabilities or contingent liabilities that would have a material effect on the financial ability of the <i>Contractor</i> to perform its work under the <i>Contract</i>.”</li> </ol>
--------	------	--

**PART 4 ALLOWANCES**

**GC 4.1 CASH ALLOWANCES**

SC27.1	4.1.3	In GC 4.1.3 <u>delete</u> the words “through the <i>Consultant</i> ” and <u>replace</u> them with “in writing.”
	4.1.4	<p><u>Delete</u> GC 4.1.4 in its entirety and <u>replace</u> it with the following:</p> <p>“4.1.4 Where the actual cost of the <i>Work</i> under any cash allowance exceeds the amount of the allowance, any unexpended amounts from other cash allowances shall be reallocated, by the <i>Consultant</i> at the <i>Owner’s</i> direction, to cover the shortfall, and, in that case, there shall be no additional amount added to the <i>Contract Price</i> for overhead and profit. Only where the actual cost of the <i>Work</i> under all cash allowances exceeds the total amount of all cash allowances shall the <i>Contractor</i> be compensated for the excess incurred and substantiated, plus an amount for overhead and profit on the excess only, as set out in the <i>Contract Documents</i>.”</p>

	4.1.7	<u>Delete</u> GC 4.1.7 in its entirety and <u>replace</u> it with the following:  “4.1.7 The net amount of any unexpended cash allowances, after providing for any reallocations as contemplated in paragraph 4.1.4, shall be deducted from the <i>Contract Price</i> by <i>Change Order</i> without any adjustment for the <i>Contractor's</i> overhead and profit on such amount.”
	4.1.8 and 4.1.9	<u>Add</u> new GC 4.1.8 and 4.1.9 as follows:  “4.1.8 The <i>Owner</i> reserves the right to call, or to have the <i>Contractor</i> call, for competitive bids for portions of the <i>Work</i> to be paid for from cash allowances.  4.1.9 Cash allowances cover the net cost to the <i>Contractor</i> of services, <i>Products</i> , <i>Construction Equipment</i> , freight, unloading, handling, storage, installation, provincial sales tax, and other authorized expenses incurred in performing any <i>Work</i> stipulated under the cash allowances but does not include any <i>Value Added Taxes</i> payable by the <i>Owner</i> and the <i>Contractor</i> .”

**PART 5 PAYMENT**

**GC 5.1 FINANCING INFORMATION REQUIRED OF THE OWNER**

SC28.1	5.1	<u>Delete</u> GC 5.1 – FINANCING INFORMATION REQUIRED OF THE OWNER and all paragraphs thereunder, including any reference to GC 5.1 throughout the <i>Contract</i> .
--------	-----	--

**GC 5.2 APPLICATIONS FOR PAYMENT**

SC29.1	5.2.1	<u>Delete</u> GC 5.2.1 and <u>replace</u> it with the following:  “5.2.1 Upon execution of the <i>Contract</i> , and in any event prior to the <i>Contractor</i> submitting its first application for payment, the <i>Owner</i> shall issue a purchase order to the <i>Contractor</i> for the performance of the <i>Contract</i> . The number indicated on such purchase order must be clearly identifiable on all applications for payment. Applications for payment shall be dated the last day of each month or an alternative day of each month agreed to in writing by the parties, with each month representing one payment period under the <i>Contract</i> (each a “ <b>Payment Period</b> ”). Within 3 calendar days of the end of each <i>Payment Period</i> , the <i>Contractor</i> will submit a draft application for payment to the <i>Owner</i> and the <i>Consultant</i> . Upon receipt of the draft application for payment, and within 7 calendar days, a representative of each of the <i>Contractor</i> , <i>Owner</i> , and the <i>Consultant</i> shall attend a meeting to discuss and review the work completed during the <i>Payment Period</i> , including quantities, if applicable (the “ <b>Pre-Invoice Submission Meeting</b> ”). In the event that the scheduled date for the <i>Pre-Invoice Submission Meeting</i> is not a <i>Working Day</i> , the <i>Pre-Invoice Submission Meeting</i> shall occur on the next <i>Working Day</i> . The <i>Contractor</i> shall bring with it to the <i>Pre-Invoice Submission Meeting</i> the following:  .1 a copy of the draft application for payment;
--------	-------	---

		<p>.2 any documents the <i>Contractor</i> is required to bring to the <i>Pre-Invoice Submission Meeting</i> as stipulated in the <i>Contract Documents</i> or as reasonably requested by the <i>Owner</i>; and</p> <p>.3 any other documents reasonably requested, in advance, by the <i>Owner</i> or the <i>Consultant</i>."</p>
SC29.2	5.2.2	<p><u>Delete</u> GC 5.2.2 in its entirety and <u>replace</u> it with the following:</p> <p>"5.2.2 Applications for payment shall be given in accordance with the following requirements:</p> <p>.1 Within 5 calendar days following the <i>Pre-Invoice Submission Meeting</i>, the <i>Contractor</i> shall deliver its application for payment to the <i>Owner</i> and to the <i>Consultant</i> for <i>Work</i> performed during the <i>Payment Period</i> ("<b>Proper Invoice Submission Date</b>") subject to the following:</p> <p>.1 If the fifth calendar day following the <i>Pre-Invoice Submission Meeting</i>, to which an invoice relates falls on a day that is not a <i>Working Day</i>, the <i>Proper Invoice Submission Date</i> shall be deemed to fall on the next <i>Working Day</i>.</p> <p>.2 The application for payment must be delivered to the <i>Owner</i> and to the <i>Consultant</i> in the same manner as a <i>Notice in Writing</i> during the hours of 9:00 am to 4:00pm (EST) on the <i>Proper Invoice Submission Date</i>. Delivery to the <i>Owner</i> shall be to the following email address:</p> <p style="text-align: center;"><b>facilities_cap@wrdsb.ca</b></p> <p>.3 If an application for payment is received after 4:00 p.m. (EST) on the applicable <i>Proper Invoice Submission Date</i>, the application for payment will not be considered or reviewed by the <i>Owner</i> and <i>Consultant</i> until the next <i>Proper Invoice Submission Date</i>. Notwithstanding the foregoing, the <i>Owner</i> in its sole and absolute discretion may elect to accept an application for payment submitted after 4:00 p.m. on the applicable <i>Proper Invoice Submission Date</i>; however, such acceptance shall not be construed as a waiver of any of its rights or waive or release the <i>Contractor's</i> obligations to strictly comply with the requirements prescribed in this subparagraph 5.2.2.3.</p> <p>.4 No applications for payment shall be accepted by the <i>Owner</i> prior to the <i>Proper Invoice Submission Date</i>.</p> <p>.5 All applications for payment shall include all of the requirements for a <i>Proper Invoice</i> prescribed by the <i>Construction Act</i> and this <i>Contract</i> and be dated the last day of the applicable <i>Payment Period</i>;"</p>
SC29.3	5.2.3	<p><u>Delete</u> GC 5.2.3 and <u>replace</u> it with the following:</p> <p>"5.2.3 The amount claimed shall be for the value, proportionate to the amount of the <i>Contract</i>, of <i>Work</i> performed and <i>Products</i> delivered and incorporated into the <i>Work</i> as of the last date of the applicable <i>Payment Period</i>. Materials may also be deemed to be supplied to an improvement, for payment purposes, when, in the <i>Owner's</i> opinion, they are placed</p>

		and properly secured on the land on which the improvement is made, or placed upon land designated by the <i>Owner</i> or agent of the <i>Owner</i> , but placing the materials on the land so designated does not, of itself, make that land subject to a lien. No amount claimed shall include products delivered and incorporated into the work, unless the products are free and clear of all security interests, liens and other claims of third parties. No amount claimed shall include <i>Products</i> delivered to the <i>Place of the Work</i> unless the <i>Products</i> are free and clear of all security interests, liens, and other claims of third parties.”
SC29.4	5.2.4	After the word “ <i>Consultant</i> ” in GC 5.2.4 <u>add</u> the words “and the <i>Owner</i> ”
SC29.5	5.2.5	After the word “ <i>Consultant</i> ” in GC 5.2.5 <u>add</u> the words “or the <i>Owner</i> ”.
SC29.6	5.2.9	<u>Add</u> new 5.2.9 as follows:  “5.2.9 The <i>Contractor</i> shall prepare and maintain current as-built drawings which shall consist of the <i>Drawings</i> and <i>Specifications</i> revised by the <i>Contractor</i> during the <i>Work</i> , showing changes to the <i>Drawings</i> and <i>Specifications</i> , which current as-built drawings shall be maintained by the <i>Contractor</i> and made available to the <i>Consultant</i> for review with each application for progress payment. The <i>Consultant</i> shall recommend to the <i>Owner</i> that the <i>Owner</i> retain a reasonable amount for the value of the as-built drawings not presented for review.”

**GC 5.3 PAYMENT**

SC30.1	5.3.1	<u>Delete</u> GC 5.3.1 in its entirety, including all subparagraphs thereunder, and <u>replace</u> it with the following:  “5.3.1 After receipt by the <i>Owner</i> and the <i>Consultant</i> of an application for payment submitted by the <i>Contractor</i> in accordance with GC 5.2 - APPLICATIONS FOR PAYMENT:  .1 the <i>Consultant</i> will either:  (a) issue to the <i>Owner</i> with a copy to the <i>Contractor</i> , a progress payment certificate in the amount applied for by the <i>Contractor</i> in the <i>Proper Invoice</i> , or  (b) issue to the <i>Owner</i> , with a copy to the <i>Contractor</i> , a certificate for payment for an amount determined by the <i>Consultant</i> to be properly due to the <i>Contractor</i> after applying any credits, withheld amounts, or other set-offs which the <i>Consultant</i> has determined that the <i>Owner</i> is entitled to notwithstanding any notice of dispute or disagreement that the <i>Contractor</i> may have served, along with the <i>Consultant’s</i> reasons why an amount other than what is claimed in the <i>Proper Invoice</i> is properly due to the <i>Contractor</i> , which finding the <i>Owner</i> may accept or amend prior to the <i>Owner</i> issuing a <i>Notice of Non-Payment</i> , if any, in accordance with GC 5.3.2;  .2 the <i>Owner</i> shall make payment to the <i>Contractor</i> on account as provided in Article A-5 PAYMENT,
--------	-------	--

		<p>(a) in the amount stated in the certificate for payment, or</p> <p>(b) in the amount stated in the certificate for payment less such amount stated in the <i>Owner's Notice of Non-Payment</i> issued pursuant to GC 5.3.3,</p> <p>on the 28th calendar day after receipt of a <i>Proper Invoice</i>, unless such 28th calendar day lands on a day that is other than a <i>Working Day</i>, in which case payment shall be made on the next <i>Working Day</i> after such 28th day."</p>
	<p>5.3.2 to 5.3.7</p>	<p><u>Add</u> new paragraphs 5.3.2, 5.3.3, 5.3.4, 5.3.4, 5.3.5, 5.3.6, and 5.3.7 as follows:</p> <p>5.3.2 All payments to the <i>Contractor</i> shall be processed using electronic funds transfer ("<b>EFT</b>") and deposited directly to the <i>Contractor's</i> bank account unless agreed to otherwise by the <i>Contractor</i> and the <i>Owner</i> in writing. Prior to the <i>Contractor</i> submitting its first application for payment, the <i>Owner</i> and the <i>Contractor</i> shall exchange such information as is necessary to facilitate <i>EFT</i> payments.</p> <p>5.3.3 In the event that the application for payment delivered by the <i>Contractor</i> pursuant to GC 5.2 - APPLICATIONS FOR PAYMENT does not include the requirements for a <i>Proper Invoice</i> or where the <i>Owner</i> disputes the amount claimed as payable in the <i>Proper Invoice</i>, then the <i>Owner</i> shall within 14 calendar days of receipt of the application for payment, issue a <i>Notice of Non-Payment</i> (Form 1.1).</p> <p>5.3.4 Where the <i>Owner</i> has delivered a <i>Notice of Non-Payment</i>, the <i>Owner</i> and the <i>Contractor</i> shall first engage in good faith negotiations to resolve the dispute. If within 5 calendar days following the issuance of a <i>Notice of Non-Payment</i>, despite good faith efforts by both parties and the assistance of the <i>Consultant</i>, the <i>Owner</i> and the <i>Contractor</i> cannot resolve the dispute, either party may commence an <i>Adjudication</i> in accordance with the procedures set out in the <i>Construction Act</i>. Any portion of the <i>Proper Invoice</i> which is not the subject of the <i>Notice of Non-Payment</i> shall be payable within the time period set out in GC 5.3.1.2.</p> <p>5.3.5 Provided that the <i>Owner</i> complies with its obligations under the <i>Construction Act</i>, and subject to any interim determination of an adjudicator in accordance with any <i>Adjudication</i>, and where applicable, a final determination made in accordance with the dispute resolution</p>

		<p>processes prescribed by this <i>Contract</i>, the <i>Owner</i> shall be entitled to claim in a <i>Notice of Non-Payment</i> a right to deduct from or, set off against, any payment of the <i>Contract Price</i>:</p> <p>.1 any amount expended by the <i>Owner</i> in exercising the <i>Owner's</i> rights under this <i>Contract</i> to perform any of the <i>Contractor's</i> obligations that the <i>Contractor</i> has failed to perform;</p> <p>.2 any damages, costs or expenses (including, without limitation, reasonable legal fees and expenses) incurred by the <i>Owner</i> as a result of the failure of the <i>Contractor</i> to perform any of its obligations under the <i>Contract</i>;</p> <p>.3 any other amount owing from the <i>Contractor</i> to the <i>Owner</i> under this <i>Contract</i>.</p> <p>5.3.6 The amounts disputed and described under the <i>Notice of Non-Payment</i> shall be held by the <i>Owner</i> until all disputed amounts of the <i>Proper Invoice</i> have been resolved pursuant to PART 8 – DISPUTE RESOLUTION.</p> <p>5.3.7 The <i>Contractor</i> represents, warrants, and covenants to the <i>Owner</i> that it is familiar with its prompt payment and trust obligations under the <i>Construction Act</i> and will take all required steps and measures to ensure that it complies with the applicable prompt payment and trust provisions under the <i>Construction Act</i> including, without limitation, section 8.1 of the <i>Construction Act</i>. Evidence of the <i>Contractor's</i> compliance under this GC 5.3.7, including evidence demonstrating that all <i>EFTs</i> by the <i>Owner</i> to the <i>Contractor</i> are kept in a bank account in the <i>Contractor's</i> name will be made available to the <i>Owner</i> within 5 <i>Working Days</i> following receipt by the <i>Contractor</i> of a <i>Notice in Writing</i> making such request.”</p>
--	--	---

**GC 5.4**

**SUBSTANTIAL PERFORMANCE OF THE WORK- AND PAYMENT OF HOLDBACK**

SC32.1	GC 5.4	<p><u>Delete</u> GC 5.4 – SUBSTANTIAL PERFORMANCE OF THE WORK AND PAYMENT OF HOLDBACK in its entirety and <u>replace</u> it with the following:</p> <p><b>“GC 5.4 SUBSTANTIAL PERFORMANCE OF THE WORK AND PAYMENT OF HOLDBACK</b></p> <p>5.4.1 When the <i>Contractor</i> considers that <i>Substantial Performance of the Work</i> has been achieved, the <i>Contractor</i> shall prepare and submit to the <i>Consultant</i> and the <i>Owner</i> a comprehensive deficiency list of items to be completed or corrected, including any incomplete <i>Close-Out Documentation</i>, and apply for a review by the <i>Consultant</i> and the <i>Owner</i> to establish <i>Substantial Performance of the Work</i>. Failure to include an item on the list does not alter the responsibility of the <i>Contractor</i> to complete the <i>Contract</i>.</p> <p>5.4.2 Prior to, or as part of its written application for <i>Substantial Performance of the Work</i> the <i>Contractor</i> shall submit to the <i>Consultant</i> submit to the <i>Consultant</i> all closeout documentation required by the <i>Contract Documents</i>, including but not limited to, warranties, manuals, guarantees, as-built drawings, warranty cards and all other relevant literature from suppliers and manufacturers including, but not limited to, where applicable</p>
--------	--------	--

		<p>(the “Close-Out Documentation”):</p> <ul style="list-style-type: none"> <li>.1 equipment, maintenance, and operations manuals;</li> <li>.2 equipment specifications, data sheets and brochures, parts lists and assembly drawings, performance curves and other related data;</li> <li>.3 line drawings, value charts and control sheets sequences with description of the sequence of operations;</li> <li>.4 warranty documents;</li> <li>.5 guarantees;</li> <li>.6 certificates;</li> <li>.7 service and maintenance reports;</li> <li>.8 <i>Specifications</i>;</li> <li>.9 <i>Shop Drawings</i>;</li> <li>.10 coordination drawings;</li> <li>.11 testing and balancing results and reports;</li> <li>.12 <i>Commissioning</i> and quality assurance documentation;</li> <li>.13 distribution system diagrams;</li> <li>.14 spare parts;</li> <li>.15 samples;</li> <li>.16 existing reports and correspondence from authorities having jurisdiction in the <i>Place of the Work</i>;</li> <li>.17 inspection certificates;</li> <li>.18 red-lined record drawings from the construction trailer in two copies and</li> <li>.19 other materials or documentation required to be submitted under the <i>Contract</i>.</li> </ul> <p>5.4.3 The <i>Consultant</i> will review the <i>Work</i> to verify the validity of the application and shall promptly, and in any event, no later than 30 calendar days after receipt of the <i>Contractor’s</i> complete deficiency list and application:</p> <ul style="list-style-type: none"> <li>.1 prepare a final deficiency list incorporating all items to be completed or corrected, including any incomplete or unsubmitted <i>Close-Out Documentation</i>. Each item shall have an indicated value for correction or completion and the determination of the total value of such items shall be determined pursuant to GC 5.8 – DEFICIENCY HOLDBACK. The final deficiency list complete with values is to be included with the <i>Consultant’s</i> draft verification and shall be reviewed with the <i>Owner</i> prior to the <i>Consultant</i> rendering a determination in accordance with GC 5.4.3.2</li> <li>.2 having completed the requirements set out in GC 5.4.3.1,             <ul style="list-style-type: none"> <li>(a) the <i>Consultant</i> shall advise the <i>Contractor</i> in writing that the <i>Work</i> or the designated portion of the <i>Work</i> is not substantially performed and give reasons why, or</li> <li>(b) the <i>Consultant</i> shall state the date of <i>Substantial Performance of the Work</i> in a certificate and issue a copy of that certificate to each the <i>Owner</i> and the <i>Contractor</i>.</li> </ul> </li> </ul> <p>5.4.4 Following the issuance of the certificate of <i>Substantial Performance of the Work</i> referenced in subparagraph 5.4.3.2(b):</p>
--	--	--



		<p>.1 The Contractor shall publish, in a construction trade newspaper in the area of the location of the Work, a copy of the certificate of <i>Substantial Performance of the Work</i> referred to in GC 5.4.2.2(b) within seven (7) calendar days of receiving a copy of the certificate signed by the <i>Consultant</i>, and the <i>Contractor</i> shall provide suitable evidence of the publication to the <i>Consultant</i> and the <i>Owner</i>. If the Contractor fails to publish such notice, the Owner shall be at liberty to publish said certificate and back-charge the Contractor its reasonable costs for doing so;</p> <p>.2 The <i>Contractor</i> shall complete the <i>Work</i> within forty (40) calendar days of the date certified as the date of <i>Substantial Performance of the Work</i>;</p> <p>.3 Notwithstanding any other provisions of the <i>Contract</i>, no payments will be processed between <i>Substantial Performance of the Work</i> and <i>Ready-for-Takeover</i>;</p> <p>.4 The <i>Owner</i> reserves the right to contract out any or all unfinished <i>Work</i> if it has not been completed within forty (40) days of <i>Substantial Performance of the Work</i> using, without limitation, the funds retained in accordance with GC 5.8 - DEFICIENCY HOLDBACK, without prejudice to any other right or remedy and without affecting the warranty period. The cost to the <i>Owner</i> of completing the <i>Work</i> including <i>Owner</i> and <i>Consultant</i> wages and materials shall be deducted from the <i>Contract Price</i>.</p> <p>5.4.5 After publication of the certificate of the <i>Substantial Performance of the Work</i>, and provided that the <i>Contractor</i> has completed performance of the <i>Work</i> within the 40 calendar days following certification of <i>Substantial Performance of the Work</i>, the <i>Contractor</i> may submit an application for payment of the outstanding <i>Construction Act</i> holdback amount, which application for payment shall:</p> <p>.1 include all of the requirements listed in EXHIBIT "1" - PROJECT SPECIFIC REQUIREMENTS FOR A PROPER INVOICE, as applicable to the application for payment of the holdback amount; and</p> <p>.2 include a statement that the <i>Contractor</i> has not received any written notices of lien or any claims for liens from any <i>Subcontractor</i> or <i>Supplier</i>.</p> <p>5.4.6 The <i>Construction Act</i> holdback amount shall become due and payable the day immediately following the expiration of the holdback period prescribed by the <i>Construction Act</i> (in most cases being the 61st calendar day following the publication of the certificate of <i>Substantial Performance of the Work</i> referred to in GC 5.4.4.1), subject to the occurrence of any of the following:</p> <p>.1 the preservation of a lien in respect of the <i>Project</i> that has not been satisfied, discharged or otherwise provided for in accordance with the <i>Construction Act</i>;</p> <p>.2 receipt by the <i>Owner</i> of a written notice of lien that has not been satisfied, discharged or otherwise provided for in accordance with the <i>Construction Act</i>; or</p> <p>.3 prior to the expiry of 40 calendar days following the publication of the certificate of <i>Substantial Performance of the Work</i>, the <i>Owner</i> publishes a <i>Notice of Non-Payment</i> of holdback in accordance with the <i>Construction Act</i> (Form 6), setting out the amount of holdback that will not be paid, which may include non-payment to secure the correction of deficiencies and/or the completion of the <i>Work</i>.</p>
--	--	---

		<p>5.4.7 Notwithstanding the <i>Owner's</i> obligation to make payment of the holdback amount in accordance with GC 5.4.6, the processing of such payment remains subject to the <i>Owner's</i> internal <i>EFT</i> timing limitations. The <i>Owner</i> covenants, and the <i>Contractor</i> agrees, that payment of the holdback shall be made by <i>EFT</i> at the first opportunity during the <i>Owner's</i> normal processing of <i>EFTs</i> upon the holdback becoming due in accordance with GC 5.4.6..</p>
--	--	---

**GC 5.5 FINAL PAYMENT**

SC35.1	GC 5.5	<p><u>Delete</u> GC 5.5 in its entirety, including all subparagraphs thereunder and <u>replace</u> it with the following:</p> <p>"5.5.1 When <i>Ready-for-Takeover</i> has been achieved in accordance with GC 12.1 – READY-FOR-TAKEOVER and the <i>Contractor</i> considers the <i>Work</i> is complete, and after the <i>Contractor</i>, the <i>Owner</i>, and the <i>Consultant</i> have attended a <i>Pre-Invoice Submission Meeting</i> analogous to the requirement in GC 5.2.1 (the "<b><i>Final Pre-Invoice Submission Meeting</i></b>"), the <i>Contractor</i> may submit an application for final payment to the <i>Owner</i> and to the <i>Consultant</i>, which application for payment shall:</p> <ul style="list-style-type: none"> <li>.1 include all of the requirements set out in GC 5.2.2, including without limitation those requirements listed in APPENDIX "1" - PROJECT SPECIFIC REQUIREMENTS FOR A PROPER INVOICE that are specific to an application for final payment; and</li> <li>.2 if applicable, (a) a certificate from the <i>Consultant</i> or written confirmation from the <i>Owner</i> that the deficiencies or incomplete <i>Work</i> waived by the <i>Owner</i> pursuant to GC 12.1.2 have been fully rectified as of the date of the <i>Contractor's</i> application for final payment, and/or (b) written confirmation, signed by the <i>Owner</i> and the <i>Contractor</i>, that the <i>Contract Price</i> has been reduced by a specified amount in exchange for the <i>Owner</i> releasing the <i>Contractor</i> of its obligation to rectify the certain outstanding deficiencies and/or incomplete <i>Work</i> waived by the <i>Owner</i> pursuant to GC 12.1.2, as detailed in such written confirmation.</li> </ul> <p>5.5.2 No later than 5 calendar days prior to the <i>Final Pre-Invoice Submission Meeting</i>, the <i>Contractor</i> will, if not already provided, submit to the <i>Consultant</i> all <i>Close-Out Documentation</i>.</p> <p>5.5.3 Delivery of all <i>Close-Out Documentation</i> is a requirement for the <i>Proper Invoice</i> for final payment.</p> <p>5.5.4 After receipt by the <i>Owner</i> and the <i>Consultant</i> of an application for payment submitted by the <i>Contractor</i> that is a <i>Proper Invoice</i> and by no later than 10 calendar days after the receipt of the <i>Proper Invoice</i>:</p> <ul style="list-style-type: none"> <li>.1 the <i>Consultant</i> will either:             <ul style="list-style-type: none"> <li>(a) issue to the <i>Owner</i> with a copy to the <i>Contractor</i>, a progress payment certificate in the amount applied for by the <i>Contractor</i> in the <i>Proper Invoice</i>, or</li> </ul> </li> </ul>
--------	--------	---

		<p>(b) deliver a finding to the <i>Owner</i> with reasons why an amount other than what is claimed in the <i>Proper Invoice</i> is properly due to the <i>Contractor</i>, which finding the <i>Owner</i> may accept or amend prior to issuing a <i>Notice of Non-Payment</i> (Form 1.1), if any, in accordance with GC 5.5.2;</p> <p>.2 the <i>Owner</i> shall make payment to the <i>Contractor</i> on account as provided in Article A-5 PAYMENT,</p> <p>(a) in the amount stated in the certificate for payment, or</p> <p>(b) in the amount stated in the certificate for payment less such amount stated in the <i>Owner's Notice of Non-Payment</i> issued pursuant to GC 5.5.5,</p> <p>on the 28th calendar day after receipt of a <i>Proper Invoice</i>, unless such 28th calendar day lands on a day that is other than a <i>Working Day</i>, in which case payment shall be made on the next <i>Working Day</i> after such 28th day.</p> <p>5.5.5 In the event that the application for final payment delivered by the <i>Contractor</i> does not include the requirements of GC 5.5.1 (including the requirements for a <i>Proper Invoice</i>) and GC 5.5.2 or where the <i>Owner</i> disputes the amount claimed as payable in the <i>Proper Invoice</i>, then the <i>Owner</i> shall within 14 calendar days of receipt of the application for payment, issue a <i>Notice of Non-Payment</i>. Where the <i>Owner</i> has delivered a <i>Notice of Non-Payment</i>, as specified under this GC 5.5.5, the <i>Owner</i> and the <i>Contractor</i> shall first engage in good faith negotiations to resolve the dispute. If within 5 calendar days following the issuance of a <i>Notice of Non-Payment</i>, despite good faith efforts by both parties with the assistance of the <i>Consultant</i>, the <i>Owner</i> and the <i>Contractor</i> cannot resolve the dispute, either party may commence an <i>Adjudication</i> in accordance with the procedures set out in the <i>Construction Act</i>. Any portion of the <i>Proper Invoice</i> which is not the subject of the <i>Notice of Non-Payment</i> shall be payable within the time period set out in GC 5.5.4.2.</p> <p>5.5.6 Subject to the provisions of the <i>Construction Act</i> and any other rights conferred on the <i>Owner</i> at law or under this <i>Contract</i> to withhold payment or back charge or set-off against payment, the <i>Owner</i> shall pay the amount payable under a <i>Proper Invoice</i> for final payment in accordance with the <i>Construction Act</i>.</p> <p>5.5.7 When the <i>Consultant</i> issues a certificate of completion in accordance with GC 5.5.4.1, the <i>Consultant</i> shall also issue a certificate for release of any holdback for finishing work amount. In accordance with the <i>Construction Act</i>, the <i>Owner</i> may retain any amounts which are required by law to satisfy any liens against the <i>Work</i>, in respect of any third party claims made to the <i>Owner</i> in respect of the <i>Contract</i> or the <i>Work</i>, and in respect of any claims the <i>Owner</i> may have against the <i>Contractor</i>. Subject to the foregoing, the <i>Owner</i> shall release the holdback in accordance with the <i>Construction Act</i>."</p>
--	--	--

**GC 5.6 DEFERRED WORK**

SC33.1	5.6.1	<p><u>Delete</u> paragraph 5.6.1 and <u>replace</u> with the following:</p> <p>“5.6.1 If because of conditions reasonably beyond the control of the <i>Contractor</i>, there are items of work that cannot be performed, payment in full for that portion of the <i>Work</i> which has been performed as certified by the <i>Consultant</i> shall not be withheld or delayed by the <i>Owner</i> on account thereof, but the <i>Owner</i> may withhold, subject to its requirement to issue a <i>Notice of Non-Payment</i> under the <i>Construction Act</i>, until the remaining portion of the <i>Work</i> is finished, only such an amount that the <i>Consultant</i> determines is sufficient and reasonable to cover the cost of performing such remaining work. The remaining work shall be valued as deficient work as defined in GC 5.8.1.”</p>
--------	-------	---

**\*NEW\* GC 5.8 DEFICIENCY HOLDBACK**

SC34.1	5.8.1	<p><u>Add</u> new GC 5.8 – DEFICIENCY HOLDBACK as follows:</p> <p><b>“GC 5.8 DEFICIENCY HOLDBACK</b></p> <p>5.8.1 Notwithstanding any provisions contained in the <i>Contract Documents</i> concerning certification and release of monies to the <i>Contractor</i>, the <i>Owner</i> reserves the right to retain a <i>Deficiency Holdback</i>, In addition to the <i>Construction Act</i> holdback. The <i>Deficiency Holdback</i> in the value of 2% shall be applied against the total <i>Contract</i> value and shall be applied to each progress payment. The <i>Deficiency Holdback</i> shall be payable to the <i>Contractor</i> upon the confirmation of completion of all deficiencies and defects in work by the <i>Consultant</i> and the <i>Owner</i>.</p> <p>5.8.2 In performing the calculation under GC 5.8.1,</p> <p style="padding-left: 20px;">.1 no individual deficiency will be valued at less than five hundred dollars (\$500.00); and</p> <p style="padding-left: 20px;">.2 for any <i>Close-Out Documentation</i> not submitted in advance of or as part of the <i>Contractor’s</i> application for <i>Substantial Performance of the Work</i>, an amount shall be retained by the <i>Owner</i> as part of the deficiency holdback that is equal to the estimated time and material costs to retain a third-party to re-create the applicable <i>Close-Out Documentation</i>, as determined by the <i>Consultant</i>, until such time as the applicable <i>Close-Out Documentation</i> is submitted and approved.</p> <p>5.8.3 The deficiency holdback shall be due and payable to the <i>Contractor</i> on the 61<sup>st</sup> day following completion of all of the deficiencies listed by the <i>Consultant</i> and confirmed to be corrected, there being no claims for lien registered against the title to the <i>Place of the Work</i> issued in accordance with the <i>Construction Act</i>, and less any amounts disputed under an <i>Owner’s Notice of Non-Payment</i> (Form 1.1).”</p>
--------	-------	--

**PART 6 CHANGES IN THE WORK**

**GC 6.1 OWNER’S RIGHT TO MAKE CHANGES**

SC37.1	6.1.2	<p><u>Add</u> the following to the end of GC 6.1.2:</p>
--------	-------	---

		<p>"This requirement is of the essence and it is the express intention of the parties that any claims by the <i>Contractor</i> for a change in the <i>Contract Price</i> and/or <i>Contract Time</i> shall be barred unless there has been strict compliance with PART 6 - CHANGES IN THE WORK. No verbal dealings between the parties and no implied acceptance of alterations or additions to the <i>Work</i> and no claims that the <i>Owner</i> has been unjustly enriched by any alteration or addition to the <i>Work</i>, whether in fact there is any such unjust enrichment or not, shall be the basis of a claim for additional payment under this <i>Contract</i>, an increase to the <i>Contract Price</i>, or a claim for any extension of the <i>Contract Time</i>."</p>
	<p>6.1.3 to 6.1.8</p>	<p><u>Add</u> new paragraphs 6.1.3, 6.1.4, 6.1.5, 6.1.6, 6.1.7 and 6.1.8 as follows:</p> <p>"6.1.3 The <i>Contractor</i> agrees that changes resulting from construction coordination, including but not limited to, scheduling, site surface conditions, site coordination, and <i>Subcontractor and Supplier</i> coordination are included in the <i>Contract Price</i> and the <i>Contractor</i> shall be precluded from making any claim for a change in the <i>Contract Price</i> as a result of such changes.</p> <p>6.1.4 Labour costs shall be actual, prevailing rates at the <i>Place of the Work</i> paid to workers, plus statutory charges on labour including WSIB, unemployment insurance, Canada pension, vacation pay, hospitalization and medical insurance. The <i>Contractor</i> shall provide these rates, when requested by the <i>Consultant</i>, for review and/or agreement.</p> <p>6.1.5 Quotations for changes to the <i>Work</i> shall only include <i>Direct Costs</i> and be accompanied by itemized breakdowns together with detailed, substantiating quotations or cost vouchers from <i>Subcontractors</i> and <i>Suppliers</i>, submitted in a format acceptable to the <i>Consultant</i> and shall include any <i>Direct Costs</i> associated with extensions in <i>Contract Time</i>.</p> <p>6.1.6 When both additions and deletions covering related <i>Work</i> or substitutions are involved in a change to the <i>Work</i>, payment, including <i>Overhead</i> and profit, shall be calculated on the basis of the net difference, if any, with respect to that change in the <i>Work</i>.</p> <p>6.1.7 Changes to the contract shall be quoted to permit the work to be executed within the <i>Contract Time</i> unless approved by the <i>Consultant</i> and the <i>Owner</i>.</p> <p>6.1.8 No extension to the <i>Contract Time</i> shall be granted for changes in the <i>Work</i> unless the <i>Contractor</i> can clearly demonstrate that such changes significantly alter the overall construction schedule submitted at the commencement of the <i>Work</i>. Extensions of <i>Contract Time</i> and all associated costs, if approved, shall be included in the relevant <i>Change Order</i>.</p> <p>6.1.9 When a change in the <i>Work</i> is proposed or required, the <i>Contractor</i> shall within 10 calendar days submit to the <i>Consultant</i> for review a claim for a change in <i>Contract Price</i> and/or <i>Contract Time</i>. Should 10 calendar days be insufficient to prepare the submission, the <i>Contractor</i> shall within 5 calendar days, advise the <i>Consultant</i> in writing of the proposed date of submission of the claim. Claims submitted after the dates prescribed herein will not be considered."</p>

--	--	--

**GC 6.2 CHANGE ORDER**

SC38.1	6.2.1	<p>In paragraph 6.2.1 after the last sentence in the paragraph <u>add</u> the following:</p> <p>“The adjustment in the <i>Contract Time</i> and the <i>Contract Price</i> shall include an adjustment, if any, for delay or for the impact that the change in the <i>Work</i> has on the <i>Work</i> of the <i>Contractor</i>, and once such adjustment is made, the <i>Contractor</i> shall be precluded from making any further claims for delay or impact with respect to the change in the <i>Work</i>.”</p>
	6.2.3 to 6.2.5	<p><u>Add</u> new paragraphs 6.2.3, 6.2.4, and 6.2.5 as follows:</p> <p>“6.2.3 The value of a change shall be determined in one or more of the following methods as directed by the <i>Consultant</i>:</p> <ul style="list-style-type: none"> <li>.1 by estimate and acceptance of a lump sum;</li> <li>.2 by negotiated unit prices which include the <i>Contractor’s</i> overhead and profit, or;</li> <li>.3 by the actual <i>Direct Cost</i> to the <i>Owner</i>, such costs to be the actual cost after all credits included in the change have been deducted, plus the following ranges of mark-up on such costs:                             <ul style="list-style-type: none"> <li>.1 Contractor on work of their own forces, 5% overhead, 5% profit.</li> <li>.2 Subcontractor on work of their own forces, 5% overhead, 5 % profit</li> <li>.3 Contractor on work of Subcontractor, 5% overhead only.</li> </ul> </li> </ul> <p>6.2.4 All quotations shall include <i>Direct Costs</i> and be submitted in a complete manner listing:</p> <ul style="list-style-type: none"> <li>.1 quantity of each material,</li> <li>.2 unit cost of each material,</li> <li>.3 man hours involved,</li> <li>.4 cost per hour,</li> <li>.5 <i>Subcontractor</i> quotations submitted listing items 1 to 4 above and item 6 below.</li> <li>.6 mark-up.</li> </ul> <p>6.2.5 The <i>Owner</i> and the <i>Consultant</i> will not be responsible for delays to the <i>Work</i> resulting from late, incomplete or inadequately broken-down valuations submitted by the <i>Contractor</i>.”</p>

**GC 6.3 CHANGE DIRECTIVE**

SC39.1	6.3.6.1	<u>Amend</u> paragraph 6.3.6.1 by deleting the final period and adding the following:  “.1 Contractors work by their own forces - 5% overhead and 5% profit, Subcontractor work by their own forces – 5% overhead and 5% profit, Contractors on Subcontractors work – 5% overhead only.
	6.3.6.2	<u>Delete</u> paragraph 6.3.6.2 and <u>replace</u> it with the following:  “.2 If a change in the <i>Work</i> results in a net decrease in the <i>Contract Price</i> , the amount of the credit shall be the net cost, without deduction for <i>Overhead</i> or profit.”
	6.3.7.1(4)	<u>Delete</u> GC 6.3.7.1(4).
	6.3.7.7	Amend GC 6.3.7.7 by <u>deleting</u> the words “described in paragraph 6.3.7.1” and <u>replacing</u> them with “approved by the <i>Owner</i> in writing and in advance of any such expenses being incurred;”
	6.3.7.9	Amend GC 6.3.7.9 by <u>adding</u> the following to the end of the paragraph:  “...when specifically requested by the <i>Owner</i> or as directed by the <i>Consultant</i> ;”.
	6.3.7.10	Amend GC 6.3.7.10 by <u>adding</u> the following to the end of the paragraph:  “, provided that such amounts are not caused by negligent acts, omissions, or default of the <i>Contractor</i> or <i>Subcontractor</i> ;”.
	6.3.7.13	<u>Delete</u> GC 6.3.7.13.
	6.3.7.15	<u>Delete</u> GC 6.3.7.15.
	6.3.7.17	<u>Delete</u> GC 6.3.7.17 in its entirety including all subparagraphs.
	6.3.11	<u>Delete</u> GC 6.3.11 and <u>replace</u> it with the following:  “6.3.11 The value of the <i>Work</i> performed as a result of a <i>Change Directive</i> shall not be eligible to be included in progress payments until the amount, including the method for determining the amount, of such <i>Change Directive</i> has been determined.”

**GC 6.4 CONCEALED OR UNKNOWN CONDITIONS**

SC40.1	6.4.1	<u>Delete</u> paragraph 6.4.1 in its entirety and <u>replace</u> with the following:  “6.4.1.1 Prior to the submission of the bid on which the Contract was awarded, the Contractor confirms that it carefully investigated the Place of the Work insofar as the Place of Work
--------	-------	--

		<p>was available for investigation and, in doing so, applied to that investigation the degree of care and skill required by paragraph 3.14.1</p> <p>6.4.1.2 No claim by the <i>Contractor</i> will be considered by the <i>Owner</i> or the <i>Consultant</i> in connection with conditions which could reasonably have been ascertained by such investigation or other due diligence undertaken prior to the execution of the <i>Contract</i>.</p>
	6.4.2	<p><u>Amend</u> paragraph 6.4.2 by <u>adding</u> a new first sentence as follows:</p> <p>“Having regard to paragraph 6.4.1, if the <i>Contractor</i> believes that the conditions of the <i>Place of the Work</i> differ materially from those reasonably anticipated, differ materially from those indicated in the <i>Contract Documents</i> and were concealed from discovery notwithstanding the conduct of the investigation described in paragraph 6.4.1, it shall provide the <i>Owner</i> and the <i>Consultant</i> with <i>Notice in Writing</i> no later than five (5) <i>Working Days</i> after the first observation of such conditions.”</p> <p>-and-</p> <p><u>amend</u> the existing second sentence of paragraph 6.4.2 in the second line, following the word “materially” by <u>adding</u> the words “or were concealed from discovery notwithstanding the conduct of the investigation described in paragraph 6.4.1,”.</p>
	6.4.3	<p><u>Delete</u> paragraph 6.4.3 in its entirety and <u>substitute</u> the following:</p> <p>“6.4.3 If the <i>Consultant</i> makes a finding pursuant to paragraph 6.4.2 that no change in the <i>Contract Price</i> or the <i>Contract Time</i> is justified, the <i>Consultant</i> shall report in writing the reasons for this finding to the <i>Owner</i> and the <i>Contractor</i>.”</p>
	6.4.5	<p><u>Add</u> new paragraph 6.4.5 as follows:</p> <p>“6.4.5 No claims for additional compensation or for an extension of <i>Contract Time</i> shall be allowed if the <i>Contractor</i> fails to give <i>Notice in Writing</i> to the <i>Owner</i> or <i>Consultant</i>, as required by paragraph 6.4.2.”</p>

**GC 6.5 DELAYS**

SC41.1	6.5.1	<p>In paragraph 6.5.1 <u>delete</u> the words after the word “for” in the fourth line and <u>replace</u> them with the words “...reasonable <i>Direct Costs</i> directly flowing from the delay, but excluding any consequential, indirect or special damages (including, without limitation, loss of profits, loss of opportunity or loss of productivity).”</p>
	6.5.2	<p><u>Delete</u> GC 6.5.2 in its entirety and <u>replace</u> it with the following:</p> <p>“6.5.2 If the <i>Contractor</i> is delayed in the performance of the <i>Work</i> by a stop work order issued by a court or other public authority and providing that such order was issued on account of a direct breach, violation, contravention, or a failure to abide by any laws, ordinances, rules, regulations, or codes by the <i>Owner</i>, <i>Other Contractor(s)</i>, or the <i>Consultant</i>, and relating to the <i>Work</i> or the <i>Place of the Work</i>, then the <i>Contract Time</i> shall be extended for such reasonable time as the <i>Consultant</i> may determine. The <i>Contractor</i> shall be reimbursed by</p>



		the <i>Owner</i> for reasonable <i>Direct Costs</i> directly flowing from the delay, but excluding any consequential, indirect or special damages (including, without limitation, loss of profits, loss of opportunity or loss of productivity).”
	6.5.3	<u>Delete</u> paragraph 6.5.3 in its entirety and <u>replace</u> with the following:  “6.5.3 If either party is delayed in the performance of their obligations under this <i>Contract</i> by <i>Force Majeure</i> , then the <i>Contract Time</i> shall be extended for such reasonable time as the <i>Owner</i> and the <i>Contractor</i> shall agree. The extension of time shall not be less than the time lost as a result of the event causing the delay, unless the parties agree to a shorter extension. Neither party shall be entitled to payment for costs incurred by such delays. Upon reaching agreement on the extension of the <i>Contract Time</i> attributable to the <i>Force Majeure</i> event, the <i>Owner</i> and the <i>Contractor</i> shall execute a <i>Change Order</i> indicating the length of the extension to the <i>Contract Time</i> and confirming that there are no costs payable by the either party for the extension of <i>Contract Time</i> . However, if at the time an event of <i>Force Majeure</i> arises a party is in default of its obligations under the <i>Contract</i> and has received a notice of default pursuant to PART 7 – DEFAULT NOTICE, this paragraph 6.5.3 shall not excuse a party from its obligation to cure the default(s). For greater certainty, the defaulting party, to the extent possible, must continue to address and cure the default notwithstanding an event of <i>Force Majeure</i> .”
	6.5.4	<u>Delete</u> paragraph 6.5.4 in its entirety and <u>replace</u> it with the following:  “6.5.4 No extension or compensation shall be made for delay or impact on the <i>Work</i> unless notice in writing of a claim is given to the <i>Consultant</i> not later than ten (10) <i>Working Days</i> after the commencement of the delays or impact on the <i>Work</i> , provided however, that, in the case of a continuing cause of delay or impact on the <i>Work</i> , only one notice of claim shall be necessary.”
	6.5.6 to 6.5.8	<u>Add</u> new paragraphs 6.5.6, 6.5.7 and 6.5.8 as follows:  “6.5.6 If the <i>Contractor</i> is delayed in the performance of the <i>Work</i> by an act or omission of the <i>Contractor</i> or anyone directly or indirectly employed or engaged by the <i>Contractor</i> , or by any cause within the <i>Contractor’s</i> control, then (i) firstly, at its expense, and to the extent possible, the <i>Contractor</i> shall accelerate the work and/or provide overtime work to recover time lost by a delay arising under this paragraph 6.5.6, and (ii) secondly, where it is not possible for the <i>Contractor</i> to recover the time lost by implementing acceleration measures and/or overtime work, the <i>Contract Time</i> may be extended for such reasonable time as the <i>Owner</i> may decide in consultation with the <i>Consultant</i> and the <i>Contractor</i> . The <i>Owner</i> shall be reimbursed by the <i>Contractor</i> for all reasonable costs incurred by the <i>Owner</i> as the result of such delay, including, but not limited to, <i>Owner’s</i> staff costs, the cost of all additional services required by the <i>Owner</i> from the <i>Consultant</i> or any sub-consultants, project managers, or others employed or engaged by the <i>Owner</i> , and in particular, the costs of the <i>Consultant’s</i> services during the period between the date of <i>Substantial Performance of the Work</i> stated in Article A-1 herein, as the same may be extended through the provision of

		<p>these General Conditions, and any later or actual date of <i>Substantial Performance of the Work</i> achieved by the <i>Contractor</i>.</p> <p>6.5.7 Without limiting the obligations of the <i>Contractor</i> described in GC 3.2 – CONSTRUCTION BY OWNER OR OTHER CONTRACTORS or GC 9.4 – CONSTRUCTION SAFETY, the <i>Owner</i> or <i>Consultant</i> may, by <i>Notice in Writing</i>, direct the <i>Contractor</i> to stop the <i>Work</i> where the <i>Owner</i> or <i>Consultant</i> determines that there is an imminent risk to the safety of persons or property at the <i>Place of the Work</i>. In the event that the <i>Contractor</i> receives such notice, it shall immediately stop the <i>Work</i> and secure the site. The <i>Contractor</i> shall not be entitled to an extension of the <i>Contract Time</i> or to an increase in the <i>Contract Price</i> unless the resulting delay, if any, would entitle the <i>Contractor</i> to an extension of the <i>Contact Time</i> or the reimbursement of the <i>Contractor’s</i> costs as provided in paragraphs 6.5.1, 6.5.2 or 6.5.3.</p> <p>6.5.8 No claim for delay shall be made by the <i>Contractor</i> and the <i>Contract Time</i> shall not be extended due to climatic conditions or arising from the <i>Contractor’s</i> efforts to maintain the <i>Construction Schedule</i>.”</p>
--	--	--

**PART 7 DEFAULT NOTICE**

**GC 7.1 OWNER’S RIGHT TO PERFORM THE WORK, TERMINATE THE CONTRACTOR’S RIGHT TO CONTINUE WITH THE WORK OR TERMINATE THE CONTRACT**

SC43.1	7.1.2	In GC 7.1.2, <u>delete</u> the words “and if the <i>Consultant</i> has given a written statement to the <i>Owner</i> and <i>Contractor</i> which provides the detail of such neglect to perform the <i>Work</i> properly or such failure to comply with the requirements of the <i>Contract</i> to a substantial degree”.
SC43.2	7.1.3.4	<u>Add</u> a new subparagraph 7.1.3.4 as follows:  “.4 an “acceptable schedule” as referred to in subparagraph 7.1.3.2. means a schedule approved by the <i>Consultant</i> and the <i>Owner</i> wherein the default can be corrected within the balance of the <i>Contract Time</i> and shall not cause delay to any other aspect of the <i>Work</i> or the work of other contractors, and in no event shall it be deemed to give a right to extend the <i>Contract Time</i> .”
	7.1.4.1	<u>Delete</u> subparagraph 7.1.4.1 and <u>replace</u> it with the following:  “.1 correct such default and deduct the cost, including <i>Owner’s</i> expenses, thereof from any payment then or thereafter due the <i>Contractor</i> .”
	7.1.4.2	<u>Delete</u> subparagraph 7.1.4.2 and <u>replace</u> it with the following:  “.2 by providing <i>Notice in Writing</i> to the <i>Contractor</i> , terminate the <i>Contractor’s</i> right to continue with the <i>Work</i> in whole or in part or terminate the <i>Contract</i> , and publish a notice of termination (Form 8) in accordance with the <i>Act</i> .”
	7.1.5.3	In subparagraph 7.1.5.3 <u>delete</u> the words: “however, if such cost of finishing the <i>Work</i> is less than the unpaid balance of the <i>Contract Price</i> , the <i>Owner</i> shall pay the <i>Contractor</i> the difference”
	7.1.6 to 7.1.10	<u>Delete</u> GC 7.1.6 and <u>replace</u> it with new paragraphs 7.1.6, 7.1.7, 7.1.8, 7.1.9 and 7.1.10 as follows:

		<p>7.1.6 In addition to its right to terminate the <i>Contract</i> set out herein, the <i>Owner</i> may terminate this <i>Contract</i> at any time for any other reason and without cause upon giving the <i>Contractor</i> fifteen (15) <i>Working Days Notice in Writing</i> to that effect. In such event, the <i>Contractor</i> shall be entitled to be paid for all <i>Work</i> performed including reasonable profit, for loss sustained upon <i>Products</i> and <i>Construction Equipment</i>, and such other damages as the <i>Contractor</i> may have sustained as a result of the termination of the <i>Contract</i>, but in no event shall the <i>Contractor</i> be entitled to be compensated for any loss of profit on unperformed portions of the <i>Work</i>, or indirect, special, or consequential damages incurred.</p> <p>7.1.7 The <i>Owner</i> may suspend <i>Work</i> under this <i>Contract</i> at any time for any reason and without cause upon giving the <i>Contractor</i> <i>Notice in Writing</i> to that effect. In such event, the <i>Contractor</i> shall be entitled to be paid for all <i>Work</i> performed to the date of suspension and be compensated for all actual costs incurred arising from the suspension, including reasonable profit, for loss sustained upon <i>Products</i> and <i>Construction Equipment</i>, and such other damages as the <i>Contractor</i> may have sustained as a result of the suspension of the <i>Work</i>, but in no event shall the <i>Contractor</i> be entitled to be compensated for any indirect, special, or consequential damages incurred. In the event that the suspension continues for more than thirty (30) calendar days, the <i>Contract</i> shall be deemed to be terminated and the provisions of paragraph 7.1.6 shall apply.</p> <p>7.1.8 In the case of either a termination of the <i>Contract</i> or a suspension of the <i>Work</i> under GC 7.1 - OWNER'S RIGHT TO PERFORM THE WORK, TERMINATE THE CONTRACTOR'S RIGHT TO CONTINUE WITH THE WORK, OR TERMINATE THE CONTRACT or GC 7.2 - CONTRACTOR'S RIGHT TO SUSPEND THE WORK OR TERMINATE THE CONTRACT, the <i>Contractor</i> shall use its best commercial efforts to mitigate the financial consequences to the <i>Owner</i> arising out of the termination or suspension, as the case may be.</p> <p>7.1.9 Upon the resumption of the <i>Work</i> following a suspension under GC 7.1 - OWNER'S RIGHT TO PERFORM THE WORK, TERMINATE THE CONTRACTOR'S RIGHT TO CONTINUE WITH THE WORK, OR TERMINATE THE CONTRACT or GC 7.2 - CONTRACTOR'S RIGHT TO SUSPEND THE WORK OR TERMINATE THE CONTRACT, the <i>Contractor</i> will endeavour to minimize the delay and financial consequences arising out of the suspension.</p> <p>7.1.10 The <i>Contractor's</i> obligations under the <i>Contract</i> as to quality, correction, and warranty of the <i>Work</i> performed by the <i>Contractor</i> up to the time of termination or suspension shall continue after such termination of the <i>Contract</i> or suspension of the <i>Work</i>."</p>
--	--	--

**GC 7.2**

**CONTRACTOR'S RIGHT TO SUSPEND THE WORK OR TERMINATE THE CONTRACT**

SC44.1	7.2.2	<p><u>Delete</u> paragraph 7.2.2 and <u>replace</u> it with the following:</p> <p>7.2.2 If the <i>Work</i> is suspended or otherwise delayed for a period of 40 consecutive <i>Working Days</i> or more under a stop work order issued by a court or other public authority on account of a breach, violation, contravention, or a failure to abide by any laws, ordinances, rules, regulations, or codes directly by the <i>Owner</i>, the <i>Owner's</i> other contractor(s), or the <i>Consultant</i>, and relating to the <i>Work</i> or the <i>Place of the Work</i>, the <i>Contractor</i> may, without</p>
--------	-------	---

		prejudice to any other right or remedy the <i>Contractor</i> may have, terminate the <i>Contract</i> by giving the <i>Owner</i> Notice in <i>Writing</i> to that effect.”
SC44.2	7.2.3.1	<u>Delete</u> subparagraph 7.2.3.1 in its entirety.
	7.2.3.2	<u>Delete</u> subparagraph 7.2.3.2 in its entirety.
	7.2.3.4	In subparagraph 7.2.3.4, <u>delete</u> the words "except for GC 5.1 - FINANCING INFORMATION REQUIRED OF THE OWNER".
	7.2.5	<u>Delete</u> paragraph 7.2.5 and <u>replace</u> it with the following: “7.2.5 If the default cannot be corrected within the 5 <i>Working Days</i> specified in paragraph 7.2.4, the <i>Owner</i> shall be deemed to have cured the default if it: .1 commences correction of the default within the specified time; .2 provides the <i>Contractor</i> with an acceptable schedule for such correction; and, .3 completes the correction in accordance with such schedule.”
	7.2.6 to 7.2.9	<u>Add</u> new paragraphs 7.2.6, 7.2.7, 7.2.8 and 7.2.9 as follows: “7.2.6 If the <i>Contractor</i> terminates the <i>Contract</i> under the conditions described in GC 7.2 – CONTRACTOR’S RIGHT TO SUSPEND THE WORK OR TERMINATE THE CONTRACT, the <i>Contractor</i> shall be entitled to be paid for all <i>Work</i> performed to the date of termination, as determined by the <i>Consultant</i> . The <i>Contractor</i> shall also be entitled to recover the direct costs associated with termination, including the costs of demobilization and losses sustained on <i>Products</i> and <i>Construction Equipment</i> . The <i>Contractor</i> shall not be entitled to any recovery for any special, indirect or consequential losses, including loss of profit. 7.2.7 The <i>Contractor</i> shall not be entitled to give notice of the <i>Owner’s</i> default or terminate the <i>Contract</i> in the event the <i>Owner</i> withholds certificates or payment or both in accordance with the <i>Contract</i> because of: .1 the <i>Contractor’s</i> failure to pay all legitimate claims promptly, or .2 the failure of the <i>Contractor</i> to discharge construction liens which are registered against the title to the <i>Place of the Work</i> . 7.2.8 The <i>Contractor’s</i> obligations under the <i>Contract</i> as to quality, correction and warranty of the <i>Work</i> performed by the <i>Contractor</i> up to the effective date of termination shall continue in force and shall survive termination of this <i>Contract</i> by the <i>Contractor</i> . 7.2.9 If the <i>Contractor</i> suspends the <i>Work</i> or terminates the <i>Contract</i> as provided for in GC 7.2 – CONTRACTOR’S RIGHT TO SUSPEND THE WORK OR TERMINATE THE CONTRACT, the <i>Contractor</i> shall ensure the site and the <i>Work</i> are left in a safe, secure condition as required by authorities having jurisdiction at the <i>Place of the Work</i> and the <i>Contract Documents</i> .”

**PART 8 DISPUTE RESOLUTION**

**GC 8.1 AUTHORITY OF THE CONSULTANT**

SC45.1	8.1.3	<p><u>Delete</u> paragraph 8.1.3 in its entirety and <u>substitute</u> as follows:</p> <p>“8.1.3 If a dispute is not resolved promptly, the <i>Consultant</i> will give such instruction as in the <i>Consultant’s</i> opinion are necessary for the proper performance of the <i>Work</i> and to prevent delays pending settlement of the dispute. The parties shall act immediately according to such instructions, it being understood that by doing so neither party will jeopardize any claim the party may have.”</p>
--------	-------	---

**GC 8.2 ADJUDICATION**

SC45.2	8.2.2 to 8.2.7	<p><u>Add</u> new GC 8.2.2, 8.2.3, 8.2.4, 8.2.5, 8.2.6, and 8.2.7 as follows:</p> <p>“8.2.2 Save and except where the <i>Contractor</i> has given an undertaking, in accordance with the <i>Act</i>, to refer a dispute to <i>Adjudication</i>, prior to delivering a notice of <i>Adjudication</i> in a form prescribed by the <i>Act</i>, the parties agree to first address all disputes with at least one in-person meeting with the <i>Owner’s</i> representative, the <i>Consultant’s</i> representative, and the <i>Contractor’s</i> representative. The parties agree that such steps will be taken to resolve any disputes in a timely and cost-effective manner.</p> <p>8.2.3 Notwithstanding any other provisions in PART 8 DISPUTE RESOLUTION, the parties shall engage in <i>Adjudication</i> proceedings as required by, and in accordance with, the <i>Construction Act</i>.</p> <p>8.2.4 The following procedures shall apply to any <i>Adjudication</i> the parties engage in under the <i>Construction Act</i>:</p> <ol style="list-style-type: none"> <li>.1 any hearings shall be held at a venue within the jurisdiction of the <i>Place of the Work</i> or such other venue as the parties may agree and which is acceptable to the adjudicator;</li> <li>.2 the <i>Adjudication</i> shall be conducted in English;</li> <li>.3 each party may be represented by counsel throughout an <i>Adjudication</i>;</li> <li>.4 there shall not be any oral communications with respect to issues in dispute that are the subject of an <i>Adjudication</i> between a party and the adjudicator unless it is made in the presence of both parties or their legal representatives; and</li> <li>.5 a copy of all written communications between the adjudicator and a party shall be given to the other party at the same time.</li> </ol> <p>8.2.5 Any documents or information disclosed by the parties during an <i>Adjudication</i> are confidential and the parties shall not use such documents or information for any purpose other than the <i>Adjudication</i> in which they are disclosed and shall not disclose such documents and information to any third party, unless otherwise required by law, save and except the for the adjudicator.</p> <p>8.2.6 If the <i>Contractor</i> fails to comply with any of the notice requirements set out in the <i>Contract</i>, including the time limits set out in any of the following:</p> <ol style="list-style-type: none"> <li>.1 GC 6.4 – CONCEALED OR UNKNOWN CONDITIONS;</li> <li>.2 GC 6.5 – DELAYS;</li> <li>.3 GC 6.6 – CLAIMS FOR A CHANGE IN CONTRACT PRICE;</li> <li>.4 PART 8 DISPUTE RESOLUTION</li> </ol>
--------	----------------	--

		<p>.5 GC 9.2 – TOXIC AND HAZARDOUS SUBSTANCES</p> <p>.6 GC 9.3 – ARTIFACTS AND FOSSILS; or</p> <p>.7 GC 9.5 - MOULD</p> <p>in respect of any claim or dispute, the <i>Contractor</i> shall have no entitlement whatsoever (including to an increase in the <i>Contract Price</i>, or an extension of <i>Contract Time</i>) in the context of an <i>Adjudication</i> under the <i>Construction Act</i> and waives the right to make any such claims or disputes in an <i>Adjudication</i>. This GC 8.2.6 shall operate conclusively as an estoppel and bar in the event such claims or disputes are brought in an <i>Adjudication</i> and the <i>Owner</i> may rely on this GC 8.2.6 as a complete defence to any such claims or disputes.</p> <p>8.2.7 The parties hereby acknowledge and agree,</p> <p>.1 that counterclaims, claims of set-off or the exercise or use of other contractual rights that permit the <i>Owner</i> to withhold, deduct or retain from monies otherwise owed to the <i>Contractor</i> under the <i>Contract</i> may be referred to, and included as part of, <i>Adjudications</i> under the <i>Construction Act</i>;</p> <p>.2 that disputes related to the termination or abandonment of the <i>Contract</i>, as well as any disputes that arise or are advanced following the termination or abandonment of the <i>Contract</i>, shall not be referred to <i>Adjudication</i> under the <i>Construction Act</i>;</p> <p>.3 that notice(s) of <i>Adjudication</i>, with respect to any dispute or claim relating to the <i>Project</i>, shall not be given, and no <i>Adjudication</i> shall be commenced following <i>Contract</i> completion, <i>Contract</i> abandonment, or termination of the <i>Contract</i>;</p> <p>.4 that any <i>Adjudication</i> between the <i>Contractor</i> and a <i>Subcontractor</i> or a supplier that relates to an <i>Adjudication</i> between the <i>Owner</i> and the <i>Contractor</i> shall be joined together to be adjudicated by a single adjudicator, provided that the adjudicator agrees to do so, and the <i>Contractor</i> shall include a provision in each of its contracts that contain an equivalent obligation to this GC 8.2.7.4; and</p> <p>.5 that, other than where the <i>Contractor</i> is obliged to commence an <i>Adjudication</i> pursuant to an undertaking under the <i>Construction Act</i>, neither the <i>Owner</i> nor the <i>Contractor</i> shall commence an <i>Adjudication</i> during the <i>Restricted Period</i>.</p> <p>8.2.8 The parties acknowledge and agree that no <i>Adjudication</i>, arbitration, action, suit or other proceeding may be brought by the <i>Contractor</i> against the <i>Owner</i> in respect of a claim for an increase to the <i>Contract Price</i> as set out in GC 6.6, before the <i>Consultant</i> has issued its findings in respect of same, pursuant to GC 6.6.5. For greater clarity and without limiting the foregoing, the amount applied for in each <i>Proper Invoice</i> shall not include any amounts pertaining to the <i>Contractor's</i> claim for an increase in <i>Contract Price</i> unless and until the <i>Consultant</i> has issued a written notice to the <i>Contractor</i> regarding the validity of such claim, as provided for in GC 6.6.5. However, nothing in this GC 8.2.8 shall prevent a <i>Contractor</i> from commencing an <i>Adjudication</i> where, pursuant to the <i>Construction Act</i>, the <i>Contractor</i> is required to give an undertaking to a <i>Subcontractor</i> to commence an <i>Adjudication</i> following delivery of a <i>Notice of Non-Payment</i>."</p>
--	--	--

**GC 8.3 NEGOTIATION, MEDIATION AND ARBITRATION**

SC46.1	8.3.1	<u>Amend</u> paragraph 8.3.1 by changing part of the second line from “shall appoint a <i>Project Mediator</i> ” to “may appoint a <i>Project Mediator</i> , except that such an appointment shall only be made if both the <i>Owner</i> and the <i>Contractor</i> agree.”
	8.3.4	<u>Amend</u> paragraph 8.3.4 by changing part of the second line from “the parties shall request the <i>Project Mediator</i> ” to “and subject to paragraph 8.3.1 the parties may request the <i>Project Mediator</i> ”.
	8.3.6 to 8.3.9	<u>Delete</u> paragraphs 8.3.6, 8.3.7 and 8.3.8 in their entirety and <u>replace</u> them with the following new GCs 8.3.6, 8.3.7, 8.3.8, and 8.3.9:  “8.3.6 The dispute may be finally resolved by arbitration under the Rules for Arbitration of Construction Disputes as provided in CCDC 40 in effect at the time of bid closing, provided that both the <i>Contractor</i> and the <i>Owner</i> agree. If the <i>Contractor</i> and the <i>Owner</i> agree to resolve the dispute by arbitration, the arbitration shall be conducted in the jurisdiction of the <i>Place of the Work</i> .  8.3.7 Prior to delivering a notice of <i>Adjudication</i> in a form prescribed by the <i>Act</i> , the parties agree to first address all disputes by attending at least one meeting with the <i>Owner’s</i> representative, the <i>Consultant’s</i> representative, and the <i>Contractor’s</i> representative, prior to commencing an <i>Adjudication</i> . The parties agree that such steps will be taken to resolve any disputes in a timely and cost effective manner. If a resolution to the dispute(s) is not made at such a meeting, any party who plans to commence an <i>Adjudication</i> shall provide the other party with 5 <i>Working Days’ Notice in Writing</i> of its intention to issue a notice of <i>Adjudication</i> .  8.3.8 Other than where the <i>Contractor</i> is obliged to commence an <i>Adjudication</i> pursuant to an undertaking under the <i>Construction Act</i> , neither the <i>Owner</i> nor the <i>Contractor</i> shall commence an <i>Adjudication</i> during the <i>Restricted Period</i> .  8.3.9 Where either party has delivered a notice of <i>Adjudication</i> in a form prescribed by the <i>Act</i> , the procedures and rules set out under the <i>Construction Act</i> and the regulations thereto shall govern the <i>Adjudication</i> .”

**PART 9 PROTECTION OF PERSONS AND PROPERTY**

**GC 9.1 PROTECTION OF WORK AND PROPERTY**

SC47.1	9.1.1.1	<u>Delete</u> subparagraph 9.1.1.1 in its entirety and <u>substitute</u> the following:  “.1 errors in the <i>Contract Documents</i> which the <i>Contractor</i> could not have discovered applying the standard of care described in paragraph 3.14.1;”
	9.1.2	<u>Delete</u> paragraph 9.1.2 in its entirety and <u>substitute</u> as follows:  “9.1.2 Before commencing any <i>Work</i> , the <i>Contractor</i> shall determine the locations of all underground or hidden utilities and structures indicated in or inferable from the <i>Contract Documents</i> , or that are inferable from an inspection of the <i>Place of the Work</i> exercising the degree of care and skill described in paragraph 3.14.1.”
	9.1.5	<u>Add</u> new paragraph 9.1.5 as follows:  “9.1.5 With respect to any damage to which paragraphs 9.1.3 or 9.1.4 apply, the <i>Contractor</i> shall neither undertake to repair or replace any damage whatsoever to the work of other

		contractors, or to adjoining property, nor acknowledge that the same was caused or occasioned by the <i>Contractor</i> , without first consulting the <i>Owner</i> and receiving written instructions as to the course of action to be followed from either the <i>Owner</i> or the <i>Consultant</i> . Where, however, there is danger to life, the environment, or public safety, the <i>Contractor</i> shall take such emergency action as it deems necessary to remove the danger.”
--	--	---

**GC 9.2 TOXIC AND HAZARDOUS SUBSTANCES**

SC48.1	9.2.1	Amend GC 9.2.1 by <u>inserting</u> the following to the end of the paragraph:  “For the purposes of GC 9.2 – TOXIC AND HAZARDOUS SUBSTANCES, <i>Excess Soil</i> shall not be considered a ‘toxic and hazardous substance’.”
SC48.2	9.2.5.5	Add a new subparagraph 9.2.5.5 as follows:  “.5 in addition to the steps described in subparagraph 9.2.5.3, take any further steps it deems necessary to mitigate or stabilize any conditions resulting from encountering toxic or hazardous substances or materials.”
	9.2.6	<u>Amend</u> GC 9.2.6 by <u>adding</u> the following words after the word “responsible” in the second line:  “or whether any toxic or hazardous substances or materials already at the <i>Place of the Work</i> (and which were then harmless or stored, contained or otherwise dealt with in accordance with legal and regulatory requirements) were dealt with by the <i>Contractor</i> or anyone for whom the <i>Contractor</i> is responsible in a manner which does not comply with legal and regulatory requirements, or which threatens human health and safety or the environment, or material damages to the property of the <i>Owner</i> or others,”.
	9.2.8	<u>Amend</u> GC 9.2.8 by <u>adding</u> the following words after the word “responsible” in the second line:  “or whether any toxic or hazardous substances or materials already at the <i>Place of the Work</i> (and which were then harmless or stored, contained or otherwise dealt with in accordance with legal and regulatory requirements) were dealt with by the <i>Contractor</i> or anyone for whom the <i>Contractor</i> is responsible in a manner which does not comply with legal and regulatory requirements, or which threatens human health and safety or the environment, or material damages to the property of the <i>Owner</i> or others,”.
	9.2.10	<u>Add</u> new paragraph 9.2.10 as follows:  “9.2.10 The <i>Contractor</i> , <i>Subcontractors</i> and <i>Suppliers</i> shall not bring on to the <i>Place of the Work</i> any toxic or hazardous substances and materials except as required in order to perform the <i>Work</i> . If such toxic or hazardous substances or materials are required, storage in quantities sufficient to allow work to proceed to the end of any current work week only shall be permitted. All such toxic and hazardous materials and substances shall be



		handled and disposed of only in accordance with all laws and regulations that are applicable at the <i>Place of the Work</i> ."
--	--	---

**GC 9.4 CONSTRUCTION SAFETY**

SC49.1	9.4.1	<p><u>Delete</u> GC 9.4.1 in its entirety and <u>replace</u> it with the following:</p> <p>"9.4.1 The <i>Contractor</i> shall be solely responsible for construction safety at the <i>Place of the Work</i> and for compliance with the rules, regulations, and practices required by the <i>OHSA</i>, including, but not limited to those of the "constructor", and shall be responsible for initiating, maintaining and supervising all safety precautions and programs in connection with the performance of the <i>Work</i>. The <i>Contractor's</i> health and safety program documentation shall be made available for review by the <i>Owner</i> or <i>Consultant</i> immediately upon request. Without limiting the foregoing, the <i>Contractor</i> shall be solely responsible for construction safety in respect of the <i>Consultant, Subcontractors and Suppliers</i>, the <i>Owner's</i> own forces, <i>Other Contractors</i>, and all persons attending the <i>Place of the Work</i> during the course of the <i>Project</i>."</p>
	9.4.2	<p>Amend GC 9.4.2 by <u>adding</u> the following words after "and the <i>Contractor</i>":</p> <p><i>, Subcontractors and Suppliers</i>".</p>
	9.4.3	<p>Amend GC 9.4.3 by <u>adding</u> the following words after "and the <i>Contractor</i>":</p> <p><i>, Subcontractors and Suppliers</i>".</p>
	9.4.4	<p><u>Delete</u> GC 9.4.4 and replace it with the following:</p> <p>"9.4.4 The <i>Owner</i> undertakes to include in its contracts with other contractors and in its instructions to its own forces the requirement that the other contractor or its own forces, as the case may be, comply with the policies and procedures of and the directions and instructions from the <i>Contractor</i> with respect to occupational health and safety and related matters."</p>
	9.4.5	<p><u>Delete</u> GC 9.4.5 in its entirety and <u>replace</u> it with the following:</p> <p>"9.4.5 Prior to the commencement of the <i>Work</i>, the <i>Contractor</i> shall submit to the <i>Owner</i>:</p> <ul style="list-style-type: none"> <li>.1 a current WSIB clearance certificate;</li> <li>.2 copies of the <i>Contractor's</i> insurance policies having application to the <i>Project</i> or certificates of insurance, at the option of the <i>Owner</i>;</li> <li>.3 documentation setting out the <i>Contractor's</i> in-house safety programs;</li> <li>.4 a copy of the Notice of Project filed with the Ministry of Labour naming itself as "constructor" under the <i>OHSA</i>; and</li> </ul>

		<p>. 5 copies of any documentation or notices to be filed or delivered to the authorities having jurisdiction for the regulation of occupational health and safety at the <i>Place of the Work</i>;"</p>
	<p>9.4.6 to 9.4.12</p>	<p><u>Add</u> new GC 9.4.6, 9.4.7, 9.4.8, 9.4.9, 9.4.10, 9.4.11, and 9.4.12 as follows:</p> <p>"9.4.6 The <i>Contractor</i> shall indemnify and save harmless the <i>Owner</i>, its agents, trustees, officers, directors, employees, consultants, successors, appointees, and assigns from and against the consequences of any and all safety infractions committed by the <i>Contractor</i> under <i>OHSA</i> and any other occupational health and safety legislation in force at the <i>Place of the Work</i> including the payment of legal fees and disbursements on a solicitor and client basis. Such indemnity shall apply to the extent to which the <i>Owner</i> is not covered by insurance.</p> <p>9.4.7 If the <i>Owner</i> is of the reasonable opinion that the <i>Contractor</i> has not taken such precautions as are necessary to ensure compliance with the requirements of paragraph 9.4.1, the <i>Owner</i> may take any remedial measures which it deems necessary, including stopping the performance of all or any portion of the <i>Work</i>, and the <i>Owner</i> may use its employees, the <i>Contractor</i>, any <i>Subcontractor</i> or any other contractors to perform such remedial measures.</p> <p>9.4.8 The <i>Contractor</i> shall file any notices or any similar document required pursuant to the <i>Contract</i> or the safety regulations in force at the <i>Place of the Work</i>. This duty of the <i>Contractor</i> will be considered to be included in the <i>Work</i> and no separate payment therefore will be made to the <i>Contractor</i>.</p> <p>9.4.9 Unless otherwise provided in the <i>Contract Documents</i>, the <i>Contractor</i> shall develop, maintain and supervise for the duration of the <i>Work</i> a comprehensive safety program that will effectively incorporate and implement all required safety precautions. The program shall, at a minimum, respond fully to the applicable safety regulations and general construction practices for the safety of persons or property, including, without limitation, any general safety rules and regulations of the <i>Owner</i> and any workers' compensation or occupational health and safety statutes or regulations in force at the <i>Place of the Work</i>.</p> <p>9.4.10 The <i>Contractor</i> shall provide a copy of the safety program described in GC 9.4.9 hereof to the <i>Consultant</i> for delivery to the <i>Owner</i> prior to the commencement of the <i>Work</i>, and shall, ensure, as far as it is reasonably practical to do so, that every employer and worker performing work in respect of the <i>Project</i> complies with such program.</p> <p>9.4.11 The <i>Contractor</i> shall arrange regular safety meetings, and shall supply and maintain, at its own expense, at its office or other well-known place at the job site, safety equipment necessary to protect the workers and general public against accident or injury as prescribed by the authorities having jurisdiction at the <i>Place of the Work</i>, including, without limitation, articles necessary for administering first-aid to any person and an emergency procedure for the immediate removal of any injured person to a hospital or a doctor's care.</p> <p>9.4.12 The <i>Contractor</i> shall promptly report in writing to the <i>Owner</i> and the <i>Consultant</i> all accidents of any sort arising out of or in connection with the performance of the <i>Work</i>, whether on or adjacent to the job site, giving full details and statement of witnesses. If death or serious injuries or damages are caused, the accident shall be promptly reported</p>

		by the <i>Contractor</i> to the <i>Owner</i> and the <i>Consultant</i> by telephone or messenger in addition to any reporting required under the applicable safety regulations.”.
--	--	---

**PART 10 GOVERNING REGULATIONS**

**GC 10.1 TAXES AND DUTIES**

SC50.1	10.1.2	<p><u>Amend</u> paragraph 10.1.2 by <u>adding</u> the following sentence to the end of the paragraph:</p> <p>“For greater certainty, the <i>Contractor</i> shall not be entitled to any mark-up for overhead or profit on any increase in such taxes and duties and the <i>Owner</i> shall not be entitled to any credit relating to mark-up for overhead or profit on any decrease in such taxes. The <i>Contractor</i> shall provide a detailed breakdown of <u>Additional</u> taxes if requested by the <i>Owner</i> in a form satisfactory to the <i>Owner</i>.”</p>
	10.1.3	<p><u>Add</u> new paragraph 10.1.3 as follows:</p> <p>“10.1.3 Where the <i>Owner</i> is entitled to an exemption or a recovery of sales taxes, customs duties, excise taxes or <i>Value Added Taxes</i> applicable to the <i>Contract</i>, the <i>Contractor</i> shall, at the request of the <i>Owner</i>, assist with the application for any exemption, recovery or refund of all such taxes and duties and all amounts recovered or exemptions obtained shall be for the sole benefit of the <i>Owner</i>. The <i>Contractor</i> agrees to endorse over to the <i>Owner</i> any cheques received from the federal or provincial governments, or any other taxing authority, as may be required to give effect to this paragraph.”</p>

**GC 10.2 LAWS, NOTICES, PERMITS, AND FEES**

SC51.1	10.2.5	<p><u>Amend</u> paragraph 10.2.5 by <u>adding</u> the words “Subject to paragraph 3.4” at the beginning of the paragraph.</p> <p>-and-</p> <p><u>Add</u> the following to the end of the second sentence:</p> <p>“...and no further <i>Work</i> on the affected components of the <i>Contract</i> shall proceed until these directives have been obtained by the <i>Contractor</i> from the <i>Consultant</i>.”</p>
	10.2.6	<p><u>Amend</u> paragraph 10.2.6 by <u>adding</u> the following sentence to the end of the paragraph:</p> <p>“In the event the <i>Owner</i> suffers loss or damage as a result of the <i>Contractor’s</i> failure to comply with paragraph 10.2.5 and notwithstanding any limitations described in paragraph 12.1.1, the <i>Contractor</i> agrees to indemnify and to hold harmless the <i>Owner</i> and the <i>Consultant</i> from and against any claims, demands, losses, costs, damages, actions suits or proceedings resulting from such failure by the <i>Contractor</i>.”</p>
	10.2.7	<p><u>Amend</u> paragraph 10.2.7 by inserting the words “which changes were not, or could not have reasonably been known to the <i>Owner</i> or to the <i>Contractor</i>, as applicable, at the time of bid closing and which changes did not arise as a result of a public emergency or other <i>Force Majeure</i> event” to the second line, after the words “authorities having jurisdiction”.</p>
	10.2.8	<p><u>Add</u> new paragraph 10.2.8 as follows:</p> <p>“10.2.8 The <i>Contractor</i> shall furnish all certificates that are required or given by the appropriate governmental authorities as evidence that the <i>Work</i> as installed conforms with the laws</p>

		and regulations of authorities having jurisdiction, including certificates of compliance for the <i>Owner's</i> occupancy or partial occupancy. The certificates are to be final certificates giving complete clearance of the <i>Work</i> , in the event that such governmental authorities furnish such certificates."
--	--	--

**GC 10.4 WORKERS' COMPENSATION**

SC52.1	10.4.1	<p><u>Delete</u> paragraph 10.4.1 and <u>replace</u> with the following:</p> <p>"10.4.1 Prior to commencing the <i>Work</i>, and with each and every application for payment thereafter, including the <i>Contractor's</i> application for payment of the holdback amount following <i>Substantial Performance of the Work</i> and again with the <i>Contractor's</i> application for final payment, the <i>Contractor</i> shall provide evidence of compliance with workers' compensation legislation in force at the <i>Place of the Work</i>, including payments due thereunder."</p>
--------	--------	--

**GC 11.1 INSURANCE**

SC53.1	11.1	<p><u>Delete</u> entirety of GC 11.1 and <u>replace</u> with the following:</p> <p><b>"GC 11.1 INSURANCE</b></p> <p>11.1.1 Without restricting the generality of GC 12 – INDEMNIFICATION, the <i>Contractor</i> shall provide, maintain, and pay for the insurance coverages specified in GC 11.1 – INSURANCE. Unless otherwise stipulated, the duration of each insurance policy shall be from the date of commencement of the <i>Work</i> until the expiration of the warranty periods set out in the <i>Contract Documents</i>. Prior to commencement of the <i>Work</i> and upon the placement, renewal, <u>amendment</u>, or extension of all or any part of the insurance, the <i>Contractor</i> shall promptly provide the <i>Owner</i> with confirmation of coverage and, if required, a certified true copy of the policies certified by an authorized representative of the insurer together with copies of any <u>amending</u> endorsements.</p> <p>.1 <b>General Liability Insurance</b></p> <p>General liability insurance shall be in the name of the <i>Contractor</i>, with the <i>Owner</i> and the <i>Consultant</i> named as <u>Additional</u> insureds, with limits of not less than \$5,000,000.00 inclusive per occurrence for bodily injury, death, and damage to property, including loss of use thereof, for itself and each of its employees, <i>Subcontractors</i> and/or agents. The insurance coverage shall not be less than the insurance required by IBC Form 2100, or its equivalent <u>replacement</u>, provided that IBC Form 2100 shall contain the latest edition of the relevant CCDC endorsement form. To achieve the desired limit, umbrella, or excess liability insurance may be used. All liability coverage shall be maintained for completed operations hazards from the date of <i>Ready-for-Takeover</i>, as set out in the certificate of <i>Ready-for-Takeover</i>, on an ongoing basis for a period of 6 years following <i>Ready-for-Takeover</i>. Where the <i>Contractor</i> maintains a single, blanket policy, the <u>Addition</u> of the <i>Owner</i> and the <i>Consultant</i> is limited to liability arising out of the <i>Project</i> and all operations necessary or incidental thereto. The policy shall be endorsed to provide the <i>Owner</i> with not less than 30 days' notice, in writing, in advance of any cancellation and of change or <u>amendment</u> restricting coverage.</p> <p>.2 <b>Automobile Liability Insurance</b></p> <p>Automobile liability insurance in respect of licensed vehicles shall limits of not less than \$2,000,000.00 inclusive per occurrence for bodily injury, death and damage to property,</p>
--------	------	--

		<p>covering all licensed vehicles <i>owned</i> or leased by the <i>Contractor</i>, and endorsed to provide the <i>Owner</i> with not less than 30 days' notice, in writing, in advance of any cancellation, change or <u>amendment</u> restricting coverage. Where the policy has been issued pursuant to a government-operated automobile insurance system, the <i>Contractor</i> shall provide the <i>Owner</i> with confirmation of automobile insurance coverage for all automobiles registered in the name of the <i>Contractor</i>.</p> <p><b>.3 Aircraft and Watercraft Liability Insurance</b></p> <p>Intentional Deleted. Not Applicable</p> <p><b>.4 Property and Boiler and Machinery Insurance</b></p> <p>(1) Builder's Risk property insurance shall be in the name of the <i>Contractor</i> with the <i>Owner</i> and the <i>Consultant</i> named as <u>Additional</u> insureds. The policy shall insure against all risks of direct physical loss or damage to the property insured which shall include all property included in the <i>Work</i>, whether owned by the <i>Contractor</i> or the owner or owned by others, so long as the property forms part of the <i>Work</i>. The property insured also includes all materials and supplies necessary to complete the work, whether installed in the work temporarily or permanently, in storage on the project site, or in transit to the project site, as well as temporary buildings, scaffolding, falsework forms, hoardings, excavation, site preparation and similar work. The insurance shall be for not less than the sum of the amount of the contract price and the full value of products that are specified to be provided by the owner for incorporation into the work, if applicable, with the deductible of \$10,000.00 payable by the contractor. The insurance shall include the foregoing and, otherwise, shall not be less than the insurance required by IBC Form 4042 or its equivalent <u>replacement</u> provided that the IBC Form 4042 shall include the latest <u>Addition</u> of the relevant CCDC endorsement form. The coverage shall be based on a completed value form and shall be maintained continuously until ten (10) days after the date of the final certificate of payment.</p> <p>(2) Boiler and machinery insurance shall be in the name of the <i>Contractor</i>, with the <i>Owner</i> and the <i>Consultant</i> named as <u>Additional</u> insureds, for not less than the <u>replacement</u> value of the boilers, pressure vessels and other insurable objects forming part of the <i>Work</i>. The insurance provided shall not be less than the insurance provided by the "Comprehensive Boiler and Machinery Form" and shall be maintained continuously from commencement of use or operation of the property insured and until 10 days after the date of the final certificate for payment.</p> <p>(3) The policies shall allow for partial or total use or occupancy of the <i>Work</i>.</p> <p>(4) The policies shall provide that, in the case of a loss or damage, payment shall be made to the <i>Owner</i> and the <i>Contractor</i> as their respective interests may appear. The <i>Contractor</i> shall act on behalf of the <i>Owner</i> for the purpose of adjusting the amount of such loss or damage payment with the insurers. When the extent of the loss or damage is determined, the <i>Contractor</i> shall proceed to restore the <i>Work</i>. Loss or damage shall not affect the rights and obligations of either party under the <i>Contract</i> except that the <i>Contractor</i> shall be entitled to such reasonable extension of the <i>Contract Time</i>, relative to the extent of the loss or damage, as determined by the <i>Owner</i>, in its sole discretion.</p>
--	--	---

		<p>(5) The <i>Contractor</i> shall be entitled to receive from the <i>Owner</i>, in <u>Addition</u> to the amount due under the <i>Contract</i>, the amount at which the <i>Owner's</i> interest in restoration of the <i>Work</i> has been appraised, such amount to be paid as the restoration of the <i>Work</i> proceeds and as provided in GC 5.2 – APPLICATIONS FOR PROGRESS PAYMENT and GC 5.3 – PROGRESS PAYMENT. In <u>Addition</u>, the <i>Contractor</i> shall be entitled to receive from the payments made by the insurer the amount of the <i>Contractor's</i> interest in the restoration of the <i>Work</i>.</p> <p>(6) In the case of loss or damage to the <i>Work</i> arising from the work of other contractors, or the <i>Owner's</i> own forces, the <i>Owner</i>, in accordance with the <i>Owner's</i> obligations under paragraph 3.2.2.4 of GC 3.2 – CONSTRUCTION BY OWNER OR OTHER CONTRACTORS, shall pay the <i>Contractor</i> the cost of restoring the <i>Work</i> as the restoration of the <i>Work</i> proceeds and as provided in GC 5.2 – APPLICATIONS FOR PROGRESS PAYMENT and GC 5.3 – PROGRESS PAYMENT.</p> <p><b>.5 Contractors' Equipment Insurance</b></p> <p>"All risks" contractors' equipment insurance covering construction machinery and equipment used by the <i>Contractor</i> for the performance of the <i>Work</i>, excluding boiler insurance, shall be in a form acceptable to the <i>Owner</i> and shall not allow subrogation claims by the insurer against the <i>Owner</i>. The policies shall be endorsed to provide the <i>Owner</i> with not less than 30 days' notice, in writing, in advance of cancellation, change or <u>amendment</u> restricting coverage. Subject to satisfactory proof of financial capability by the <i>Contractor</i> for self-insurance of his equipment, the <i>Owner</i> agrees to waive the equipment insurance requirement.</p> <p>11.1.2 The <i>Contractor</i> shall be responsible for deductible amounts under the policies except where such amounts may be excluded from the <i>Contractor's</i> responsibility by the terms of GC 9.1 - PROTECTION OF WORK AND PROPERTY and GC 9.2 - DAMAGES AND MUTUAL RESPONSIBILITY.</p> <p>11.1.3 Where the full insurable value of the <i>Work</i> is substantially less than the <i>Contract Price</i>, the <i>Owner</i> may reduce the amount of insurance required to waive the course of construction insurance requirement.</p> <p>11.1.4 If the <i>Contractor</i> fails to provide or maintain insurance as required by the <i>Contract Documents</i>, then the <i>Owner</i> shall have the right to provide and maintain such insurance and provide evidence of same to the <i>Contractor</i>. The <i>Contractor</i> shall pay the costs thereof to the <i>Owner</i> on demand, or the <i>Owner</i> may deduct the amount that is due or may become due to the <i>Contractor</i>.</p> <p>11.1.5 All required insurance policies shall be with insurers licensed to underwrite insurance in the jurisdiction of the <i>Place of the Work</i>."</p>
--	--	--

**\*NEW\* GC 11.2 CONTRACT SECURITY**

SC52.1	GC 11.2	<u>Add</u> new GC 11.2 – CONTRACT SECURITY as follows:
--------	---------	--

		<p><b>“GC 11.2 CONTRACT SECURITY</b></p> <p>11.2.1 The <i>Contractor</i> shall, prior to the execution of the <i>Contract</i>, furnish a performance bond and labour and material payment bond which meets the requirements under paragraph 11.2.2.</p> <p>11.2.2 The performance bond and labour and material payment bond shall:</p> <ul style="list-style-type: none"> <li>.1 be issued by a duly licensed surety company, which has been approved by the <i>Owner</i> and is permitted under the <i>Construction Act</i>,</li> <li>.2 be issued by an insurer licensed under the <i>Insurance Act</i> (Ontario) and authorized to transact a business of suretyship in the Province of Ontario;</li> <li>.3 shall be in the form prescribed by the <i>Construction Act</i>;</li> <li>.4 have a coverage limit of at least 50 per cent of the <i>Contract Price</i>, or such other percentage of the <i>Contract Price</i> as stated in the <i>Contract Documents</i>;</li> <li>.5 extends protection to <i>Subcontractors, Suppliers</i>, and any other persons supplying labour or materials to the <i>Project</i>; and</li> <li>.6 shall be maintained in good standing until the fulfillment of the <i>Contract</i>, including all warranty and maintenance periods set out in the <i>Contract Documents</i>..</li> </ul> <p>11.2.3 It is the intention of the parties that the performance bond shall be applicable to all of the <i>Contractor’s</i> obligations in the <i>Contract Document</i> and, wherever a performance bond is provided with language which conflicts with this intention, it shall be deemed to be amended to comply. The <i>Contractor</i> represents and warrants to the <i>Owner</i> that it has provided its surety with a copy of the <i>Contract Documents</i> prior to the issuance of such bonds.</p> <p>11.2.4 Without limiting the foregoing in any way, the bonds shall indemnify and hold harmless the <i>Owner</i> for and against costs and expenses (including legal and <i>Consultant</i> services and court costs) arising out of or as a consequence of any default of the <i>Contractor</i> under this <i>Contract</i>.</p> <p>11.2.4 The <i>Contractor</i> shall be responsible for notifying the surety company of any changes made to the <i>Contract</i> during the course of construction.</p> <p>11.2.5 The premiums for bonds required by the <i>Contract Documents</i> shall be included in the <i>Contract Price</i>.</p> <p>11.2.6 Should the <i>Owner</i> require additional bonds by the <i>Contractor</i> or any of his <i>Subcontractors</i>, after the receipt of bids for the <i>Work</i>, the <i>Contract Price</i> shall be increased by all direct costs attributable to providing such bonds. The <i>Contractor</i> shall promptly provide the <i>Owner</i>, through the <i>Consultant</i>, with any such bonds that may be required.”</p>
--	--	---

**PART 12 OWNER TAKEOVER**

**GC 12.1 READY-FOR-TAKEOVER**

SC55.1	12.1.1	<p><u>Delete</u> GC 12.1.1 in its entirety and <u>replace</u> it with the following:</p> <p>“12.1.1 <i>Ready-for-Takeover</i> shall be achieved when all of the following has occurred, as verified and approved by the <i>Owner</i>:</p> <ul style="list-style-type: none"> <li>.1 <i>Substantial Performance of the Work</i> has been achieved, as certified by the <i>Consultant</i>;</li> </ul>
--------	--------	---

		<p>.2 a permit for occupancy of the <i>Place of the Work</i> has been obtained from the authorities having jurisdiction;</p> <p>.3 the <i>Work</i> to be performed under the <i>Contract</i> has satisfied the requirements for deemed completion in accordance with Section 2(3) of the <i>Construction Act</i>,</p> <p>.4 final cleaning and waste removal, as required by the <i>Contract Documents</i>;</p> <p>.5 the <i>Contractor</i> has delivered to the <i>Consultant</i> and the <i>Owner</i> all inspection certificates from authorities having jurisdiction with respect to any component of the <i>Work</i> which has been completed;</p> <p>.6 subject only to GC 12.1.2, the entire <i>Work</i> has been completed to the requirements of the <i>Contract Documents</i>, including completion of all items on the punch list prepared at the time of <i>Substantial Performance of the Work</i> and the <i>Work</i> is being used for its intended purpose, and is so certified by the <i>Consultant</i>;</p> <p>.7 subject only to GC 12.1.2, the <i>Contractor</i> has submitted to the <i>Owner</i> and the <i>Consultant</i> in a collated and organized matter, all <i>Close-Out Documentation</i> and any other materials or documentation required by the <i>Contract Documents</i>;</p> <p>.8 subject only to GC 12.1.2, all <i>Products</i>, systems and components of the <i>Project</i> have been commissioned and certified for operation and accepted by the <i>Owner</i> and <i>Consultant</i>, and</p> <p>9 subject only to GC 12.1.2, the <i>Contractor</i> has submitted to the <i>Owner</i> and the <i>Consultant</i> full and complete as-built drawings and <i>Specifications</i> revised by the <i>Contractor</i> to reflect the as-built state of the <i>Work</i>, clearly showing changes to the <i>Drawings</i> and <i>Specifications</i> from the original <i>Contract Documents</i>, all of which have been approved by the <i>Owner</i> acting reasonably.”</p>
SC55.2	12.1.2	<p><u>Delete</u> GC 12.1.2 in its entirety and <u>replace</u> it with the following:</p> <p>“12.1.2 The <i>Owner</i> may, in its sole, absolute, and unfettered discretion, waive compliance with a requirement, or a part thereof, for achieving <i>Ready-for-Takeover</i> set out in GC 12.1.1.6 to 12.1.1.9 (inclusive). Where the <i>Owner</i> exercises the discretion afforded under this GC 12.1.2, the <i>Contractor</i> shall be required to comply with GC 5.5.1.2 as part of its application for final payment and the <i>Owner</i> and the <i>Contractor</i>, in consultation with the <i>Consultant</i>, shall establish a reasonable date for completing the <i>Work</i>.”</p>
SC55.3	12.1.3	<p><u>Delete</u> GC 12.1.3 in its entirety and <u>replace</u> it with the following:</p> <p>“12.1.3 When the <i>Contractor</i> considers the <i>Work Ready-for-Takeover</i>, it shall submit a written application to the <i>Owner</i> and the <i>Consultant</i> for review.”</p>
SC55.4	12.1.4	In GC 12.1.4, <u>delete</u> the words “list and” from the second line.
SC55.5	12.1.5	<u>Delete</u> GC 12.1.5 in its entirety and <u>replace</u> it with the following:



		"12.1.5 Following the confirmation of the date of <i>Ready-for-Takeover</i> by the <i>Consultant</i> and as confirmed by the <i>Owner</i> , the <i>Contractor</i> may submit a final application for payment in accordance with GC 5.5 – FINAL PAYMENT."
SC55.6	12.1.6	<u>Delete</u> GC 12.1.6 in its entirety.

**GC 12.2 EARLY OCCUPANCY**

SC56.1	GC 12.2	<p><u>Delete</u> GC 12.2 – EARLY OCCUPANCY BY THE OWNER in its entirety, including all subparagraphs thereunder and <u>replace</u> it with the following:</p> <p>"12.2.1 The Owner reserves the right to take possession of and use for any intended purpose any portion or all of the undelivered portion of the Project even though the Work may not have reached Substantial Performance of the Work. Where the Work extends beyond the Contract Time, progress and completion of the Work shall not unduly interfere with the delivery of scheduled school programs. The taking of possession or use of any such portion of the Project shall not be deemed to be the Owner's acknowledgement or acceptance of the Work or Project nor shall it relieve the Contractor of any of its obligations under the Contract.</p> <p>12.2.2 Whether the Project contemplates Work by way of renovations in buildings which will be in use or be occupied during the course of the Work or where the Project involves Work that is adjacent to a structure which is in use or is occupied, the Contractor, without in any way limiting its responsibilities under this Contract, shall take all reasonable steps to avoid interference with fire exits, building access and egress, continuity of electric power and all other utilities, to suppress dust and noise and to avoid conditions likely to propagate mould or fungus of any kind and all other steps reasonably necessary to promote and maintain the safety and comfort of the users and occupants of such structures or adjacent structures."</p>
--------	---------	---

**GC 12.3 WARRANTY**

SC57.1	12.3.1	<u>Delete</u> from the first line of paragraph 12.3.1 the words "one year" and <u>replace</u> it with the words "two years"
	12.3.2	<u>Delete</u> from the first line of paragraph 12.3.2 the word "The" and <u>replace</u> it with the words "Subject to GC 1.1.3, the..."
	12.3.7 to 12.3.12	<p><u>Add</u> new paragraphs 12.3.7 to 12.3.12 as follows:</p> <p>"12.3.7 Where required by the <i>Contract Documents</i>, the <i>Contractor</i> shall provide a maintenance bond as security for the performance of the <i>Contractor's</i> obligations as set out in GC 12.3 WARRANTY.</p> <p>12.3.8 The <i>Contractor</i> shall provide fully and properly completed and signed copies of all warranties and guarantees required by the <i>Contract Documents</i>, containing:</p> <p>.1 the proper name of the <i>Owner</i>;</p> <p>.2 the proper name and address of the <i>Project</i>;</p>

		<p>.3 the date the warranty commences, which shall be at the “<i>Ready-for-Takeover</i>” unless otherwise agreed upon by the <i>Consultant</i> in writing.</p> <p>.4 a clear definition of what is being warranted and/or guaranteed as required by the <i>Contract Documents</i>; and</p> <p>.5 the signature and seal (if required by the governing law of the <i>Contract</i>) of the company issuing the warranty, countersigned by the <i>Contractor</i>.</p> <p>12.3.9 Should any <i>Work</i> need to be repaired or replaced during the time period for which it is covered by the specified warranty, a new warranty shall be provided under the same conditions and for the same period as specified herein before. The new warranty shall commence at the completion of the repair or replacement.</p> <p>12.3.10 The <i>Contractor</i> shall ensure that its <i>Subcontractors</i> are bound to the requirements of GC 12.3 – WARRANTY for the <i>Subcontractor’s</i> portion of the <i>Work</i>.</p> <p>12.3.11 The <i>Contractor</i> shall ensure that all warranties, guarantees or other obligations for <i>Work, services or Products</i> performed or supplied by any <i>Subcontractor, Supplier</i> or other person in connection with the <i>Work</i> are obtained and available for the direct benefit of the <i>Owner</i>. In the alternative, the <i>Contractor</i> shall assign to the <i>Owner</i> all warranties, guarantees or other obligations for <i>Work, services or Products</i> performed or supplied by any <i>Subcontractor, Supplier</i> or other person in connection with the <i>Work</i> and such assignment shall be with the consent of the assigning party, where required by law, or by the terms of that party’s contract. Such assignment shall be in addition to, and shall in no way limit, the warranty rights of the <i>Owner</i> under the <i>Contract Documents</i>.</p> <p>12.3.12 The <i>Contractor</i> shall commence or correct any deficiency within 2 <i>Working Days</i> after receiving a <i>Notice in Writing</i> from the <i>Owner</i> or the <i>Consultant</i>, and shall complete the <i>Work</i> as expeditiously as possible, except in the case where the deficiency prevents maintaining security or where basic systems essential to the ongoing business of the <i>Owner</i> and/or its tenants cannot be maintained operational as designed. In those circumstances all necessary corrections and/or installations of temporary replacements shall be carried out immediately as an emergency service. Should the <i>Contractor</i> fail to provide this emergency service within 8 hours of a request being made during the normal business hours of the <i>Contractor</i>, the <i>Owner</i> is authorized, notwithstanding GC 3.1, to carry out all necessary repairs or replacements at the <i>Contractor’s</i> expense.”</p>
--	--	--

**PART 13 INDEMNIFICATION AND WAIVER**

**GC 13.1 INDEMNIFICATION**

SC58.1	GC 13.1	<p><u>Delete</u> GC 13.1 – INDEMNIFICATION in its entirety and <u>replace</u> it with the following:</p> <p>“13.1.1 The <i>Contractor</i> shall indemnify and hold harmless the <i>Owner</i>, its parent, subsidiaries and affiliates, their respective partners, trustees, officers, directors, agents and employees and the <i>Consultant</i> from and against any and all claims, liabilities, expenses, demands, losses, damages, actions, costs, suits, or proceedings (hereinafter called “claims”), whether in respect of claims suffered by the <i>Owner</i> or in respect of claims by third parties, that directly or indirectly arise out of, or are attributable to, the acts or</p>
--------	---------	--

		<p>omissions of the <i>Contractor</i>, its employees, agents, <i>Subcontractors</i>, <i>Suppliers</i> or any other persons for whom it is in law responsible (including, without limitation, claims that directly or indirectly arise out of, or are attributable to, loss of use or damage to the <i>Work</i>, the <i>Owner's</i> property or equipment, the <i>Contractor's</i> property or equipment or equipment or property adjacent to the <i>Place of the Work</i> or death or injury to the <i>Contractor's</i> personnel).</p> <p>13.1.2 The <i>Owner</i> shall indemnify and hold the <i>Contractor</i>, its agents and employees harmless from and against claims, demands, losses, costs, damages, actions, suits or proceedings arising out of the <i>Contractor's</i> performance of the <i>Contract</i> which are attributable to a lack of or defect in title or an alleged lack of or defect in title to the <i>Place of the Work</i>.</p> <p>13.1.3 The provisions of GC 13.1 - INDEMNIFICATION shall survive the termination of the <i>Contract</i>, howsoever caused and no payment or partial payment, no issuance of a final certificate of payment and no occupancy in whole or in part of the <i>Work</i> shall constitute a waiver or release of any of the provisions of GC 13.1</p> <p>13.1.4 Notwithstanding the provisions of GC1.1 - CONTRACT DOCUMENTS, GC 1.1.6, GC13.1 - INDEMNIFICATION shall govern over the provisions of GC 1.3.1 of GC1.3 – RIGHTS AND REMEDIES.”</p>
--	--	---

**GC 13.2 WAIVER OF CLAIMS**

	13.2.1	<p>In paragraph 13.2.1 in the third line after the word “limitation” <u>add</u> the words “claims for delay pursuant to GC 6.5 DELAYS”</p> <p>-and-</p> <p><u>add</u> the words “(collectively “<b>Claims</b>”)” after “<i>Ready-for-Takeover</i>” in the fourth line.</p>
	13.2.1.1	In subparagraph 13.2.1.1, in each instance change the word “claims” to “Claims” and change the word “claim” to “Claim”.
	13.2.1.2	In subparagraph 13.2.1.2 change the word “claims” to “Claims”.
	13.2.1.3	<u>Delete</u> subparagraph 13.2.1.3 in its entirety.
	13.2.1.4	In paragraph 13.2.1.4 change the word “claims” to “Claims”.
	13.2.2.1	<p>In paragraph 13.2.2.1 <u>delete</u> the words “in paragraphs 13.2.1.2 and 13.2.1.3” and <u>replace</u> them with “in paragraph 13.2.1.2”</p> <p>-and-</p> <p>change the word “claims” to “Claims” in both instances and change the word “claim” to “Claim”.</p>

	13.2.3	<u>Delete</u> paragraph 13.2.3 in its entirety.
	13.2.4	<u>Delete</u> paragraph 13.2.4 in its entirety.
	13.2.5	<u>Delete</u> paragraph 13.2.5 in its entirety.
	13.2.6	In paragraph 13.2.6 change the word “claim” to “Claim” in all instances in the paragraph.
	13.2.8	In paragraph 13.2.8 change “The party” to “The <i>Contractor</i> ” -and- change the word “claim” to “Claim” in all instances in the paragraph.
	13.2.9	In paragraph 13.2.9 <u>delete</u> the words “under paragraphs 13.2.1 or 13.2.3” and <u>replace</u> them with “under paragraph 13.2.1” -and- change both instances of the words “the party” to “the <i>Contractor</i> ”. Change the word “claim” to “Claim” in all instances in the paragraph.

**\*NEW\* PART 14 OTHER PROVISIONS**

SC58.1	14.1	<u>Add</u> new PART 14 – OTHER PROVISIONS as follows:  <b>“PART 14 OTHER PROVISIONS</b>  <b>GC 14.1 OWNERSHIP OF MATERIALS</b>  14.1.1 Unless otherwise specified, all materials existing at the <i>Place of the Work</i> at the time of execution of the <i>Contract</i> shall remain the property of the <i>Owner</i> . All <i>Work</i> and <i>Products</i> delivered to the <i>Place of the Work</i> by the <i>Contractor</i> shall be the property of the <i>Owner</i> . The <i>Contractor</i> shall remove all surplus or rejected materials as its property when notified in writing to do so by the <i>Consultant</i> .”
	14.2	<u>Add</u> new GC 14.2 – CONSTRUCTION LIENS as follows:  <b>“GC 14.2 LIENS</b>  14.2.1 Notwithstanding any other provision in the <i>Contract</i> , the <i>Consultant</i> shall not be obligated to issue a certificate, and the <i>Owner</i> shall not be obligated to make payment,

		<p>subject to the <i>Owner's</i> requirement to issue a <i>Notice of Non-Payment</i> (Form 1.1) to the <i>Contractor</i>, if at the time such certificate or payment was otherwise due:</p> <ul style="list-style-type: none"> <li>.1 a claim for lien has been registered against the <i>Project</i> lands by a <i>Subcontractor</i> or a <i>Supplier</i> that has not been vacated or discharged by the <i>Contractor</i> in accordance with the requirements of this <i>Contract</i>, or</li> <li>.2 if the <i>Owner</i> or a mortgagee of the <i>Project</i> lands has received a written notice of a lien that has not been resolved by the <i>Contractor</i> through the posting of security or otherwise.</li> </ul> <p>14.2.2 In the event a construction lien arising from the performance of the <i>Work</i> is registered or preserved against the <i>Project</i> lands by a <i>Subcontractor</i> or a <i>Supplier</i>, or a written notice of a lien is given or a construction lien action is commenced against the <i>Owner</i> by a <i>Subcontractor</i> or a <i>Supplier</i>, then the <i>Contractor</i> shall, at its own expense:</p> <ul style="list-style-type: none"> <li>.1 within 10 calendar days of registration of the construction lien, vacate or discharge the lien from title to the premises (i.e. the <i>Place of the Work</i>). If the lien is merely vacated, the <i>Contractor</i> shall, if requested, undertake the <i>Owner's</i> defence of any subsequent action commenced in respect of the lien, at the <i>Contractor's</i> sole expense;</li> <li>.2 within 10 calendar days of receiving notice of a written notice of a lien, post security with the Ontario Superior Court of Justice so that the written notice of a lien no longer binds the parties upon whom it was served; and</li> <li>.3 satisfy all judgments and pay all costs arising from such construction liens and actions and fully indemnify the <i>Owner</i> against all costs and expenses arising from same, including legal costs on a full indemnity basis.</li> </ul> <p>14.2.3 In the event that the <i>Contractor</i> fails or refuses to comply with its obligations pursuant to paragraph 14.2.2, the <i>Owner</i> shall, at its option, be entitled to take all steps necessary to address any such construction liens including, without limitation and in addition to the <i>Owner's</i> rights under paragraph 13.2.4, the posting of security with the Ontario Superior Court of Justice to vacate the claim for lien from title to the <i>Project</i> lands, and in so doing will be entitled to a full indemnity from the <i>Contractor</i> for all legal fees, security, disbursements and other costs incurred and will be entitled to deduct same from amounts otherwise owing to the <i>Contractor</i>.</p> <p>14.2.4 In the event that any <i>Subcontractor</i> or <i>Supplier</i> registers any claim for lien with respect to all or part of the <i>Place of Work</i>, the <i>Owner</i> shall have the right to withhold, in addition to the statutory holdback, the full amount of said claim for lien plus either: (a) \$250,000 if the claim for lien is in excess of \$1,000,000 or (b) 25% of the value of the claim for lien and to bring a motion to vacate the registration of said claim for lien and any associated certificate of action in respect of that lien, in accordance with Section 44 of the <i>Act</i>, by paying into court as security the amount withheld.</p> <p>14.2.5 Nothing in this GC 14.2 serves to preclude the <i>Contractor</i> from preserving and perfecting its lien in the event of non-payment by the <i>Owner</i>."</p>
--	--	--

---

**APPENDIX 1**  
**to the Supplementary Conditions**

**Project-specific requirements for a “*Proper Invoice*”**

To satisfy the requirements for a *Proper Invoice*, the following criteria, as may be applicable in each case, must be included with the *Contractor’s* application for payment:

- .1 the written bill or request for payment must be in writing;
- .2 the *Contractor’s* name and current address;
- .3 the *Contractor’s* HST registration number;
- .4 the date the application for payment was prepared by the *Contractor*;
- .5 the period of time in which the services or materials were supplied to the *Owner*;
- .6 the purchase order number provided by the *Owner*;
- .7 reference to the provisions of the *Contract* under which payment is being sought (e.g. GC 5.3 –PAYMENTS for progress payments, GC 5.4 – SUBSTANTIAL PERFORMANCE OF THE WORK AND PAYMENT OF HOLDBACK GC 5.5 – FINAL PAYMENT for final payment, etc.);
- .8 a description, including quantities where appropriate, of the services or materials, or a portion thereof, that were supplied and form the basis of the *Contractor’s* request for payment;
- .9 the amount the *Contractor* is requesting to be paid by the *Owner*, set out in a statement based on the schedule of values approved under GC 5.2.4, separating out any statutory or other holdbacks, set-offs and HST;
- .10 a sworn Statutory Declaration in the form CCDC 9A-2018, only for second and subsequent progress payments;
- .11 a current Workplace Safety Insurance Board clearance certificate;
- .12 a pre-approved schedule of values, supplied by the *Contractor*, for Divisions 1 through 14 of the *Specifications* (or equivalent Construction Specifications Institute Masterformat) of the *Work*, aggregating the total amount of the *Contract Price*, including all supporting invoicing;
- .13 a separate pre-approved schedule of values, supplied by each *Subcontractor*, for each of Division 15, 16, and 17 of the *Specifications* (or equivalent Construction Specifications Institute Masterformat) of the *Work*, aggregating the total amount of the *Contract Price*, including all supporting invoicing;
- .14 invoices and other supporting documentation for all claims against the cash allowance;
- .15 a current, acceptable, and up to date *Construction Schedule Update*;
- .16 if requested by the *Owner*, a current and valid certificate(s) of insurance as required under GC 11.1 – INSURANCE;
- .17 the name, title, telephone number and mailing address of the person at the place of business of the *Contractor* to whom payment is to be directed;
- .18 a current, up to date, and approved *Shop Drawing* log;
- .19 in the case of the *Contractor’s* application for final payment, in addition to the foregoing requirements (as applicable):
  - (a) any *Close-Out Documentation*, together with complete and final as-built drawings;

- (b) the *Contractor's* written request for release of the deficiency holdback, including a statement that no written notices of lien have been received by it;
- (c) the *Contractor's* written certification that there are no outstanding claims, pending claims or future claims from the *Contractor* or their *Subcontractors* or *Suppliers*; and
- (d) sufficient evidence of the *Contractor's* compliance with GC 3.11.

**END OF THE SUPPLEMENTARY CONDITIONS**

## **01 14 00 – Work Restrictions**

### **1.0 GENERAL**

#### **1.1. SECTION INCLUDES**

- .1 Connecting to existing services.
- .2 Special scheduling requirements.

#### **1.2. RELATED SECTIONS**

- .1 Section 01 53 00 - Temporary Construction.
- .2 Section 01 33 00 - Submittal Procedures.
- .3 This Section describes requirements applicable to all Sections within Divisions 02 to 49.

#### **1.3. EXISTING SERVICES**

- .1 Notify Owner and Consultant and utility companies of intended interruption of services and obtain required permission.
- .2 Where Work involves breaking into or connecting to existing services, give Consultant and Owner forty-eight (48) hours of notice for necessary interruption of mechanical or electrical service throughout the course of work.
  - .1 Keep duration of interruptions minimum.
  - .2 Perform interruptions after normal working hours of occupants, preferably on weekends.
- .2 Provide for vehicular, pedestrian and personnel traffic.
- .3 Construct barriers in accordance with Section 01 53 00.

#### **1.4. AFTER HOURS WORK**

- .1 Schedule Work with school staff through the Board's contact so as to limit disruption to school operations. Include for any overtime, to ensure orderly and continuous progression of Work and operation of school.
- .2 Direct calls from Contractors to Board staff to adjust alarms and to arrange for access will not be accepted. All correspondence must be through the Project Manager.
- .3 Arrange 48 hours in advance with the Board to obtain an access card and adjust security alarms for after hours Work.



- .4 Bidders are cautioned that the Board will be compensated by the Contractor for false alarms. Any costs associated with each false alarm will be levied against the Contractor for false fire alarm activation or security alarm activation. These costs may include, but are not limited to:
  - .1 Fines or penalties imposed by the local Fire Services,
  - .2 Fines or penalties imposed by the local Police Services,
  - .3 Overtime costs borne by the Board.
- .5 Contractors are responsible for ensuring doors and windows are secured prior to leaving school.
- .6 Unless specifically stated otherwise school activities take precedence over Contractor's activities.

**1.5. SPECIAL REQUIREMENTS**

- .1 Schedule and perform work in occupied areas to the Board Representative's approval.
- .2 Schedule and perform noise generating work to the Board Representative's approval.
- .3 Submit schedule of special requirements or disruptions in accordance with Section 01 33 00.
- .4 All Contractor personnel are restricted to the job site and necessary access routes. No personnel shall visit other areas or buildings without specific authorization.

**END OF SECTION**

## **01 19 00 – Specifications and Documents**

### **1.0 GENERAL**

#### **1.1. RELATED DOCUMENTS**

- .1 This Section describes requirements applicable to all sections within Divisions 02 to 49.

#### **1.2. WORDS AND TERMS**

- .1 Conform to definitions and their defined meanings in the Agreement and Definitions portion of CCDC 2 for Supplementary Words and Terms listed in Section 00 56 13.

#### **1.3. COMPLEMENTARY DOCUMENTS**

- .1 Generally, drawings indicate graphically, the dimensions and location of components and equipment. Specifications indicate specific components, assemblies, and identify quality.
- .2 Drawings, specifications, diagrams and schedules are complementary, each to the other, and what is required by one, to be binding as if required by all.
- .3 Should any conflict or discrepancy appear between documents, which leaves doubt as to the intent or meaning, apply the Precedence of Documents article below or obtain guidance or direction from Consultant.
- .4 Examine all discipline drawings, specifications, schedules, diagrams and related Work to ensure that Work can be satisfactorily executed.
- .5 All specification sections of the Project Manual and Drawings are affected by requirements of Division 01 sections.

#### **1.4. PRECEDENCE OF DOCUMENTS**

- .1 In the event of conflict within and between the Contract Documents, the order of priority within specifications and drawings for this project are - from highest to lowest:
  - .1 the Agreement and Definitions between the Owner and the Construction
  - .2 the Defined Terms, Definitions;
  - .3 Supplementary Conditions;
  - .4 the General Conditions;
  - .5 Sections of Division 01 of the specifications;
  - .6 Technical specifications Sections of Divisions 02 through 49 of the specifications.

- .7 Schedules and Keynotes:
  - .1 Material and finishing schedules within the specifications, then;
  - .2 Material and finishing schedules on drawings, then;
  - .3 Keynotes and definitions thereto, then;
- .8 Drawings:
  - .1 Drawings of larger scale shall govern over those of smaller scale of the same date, then;
  - .2 Dimensions shown on drawings shall govern over dimensions scaled from drawings, then;
  - .3 Location of utility outlets indicated on architectural detail drawings takes precedence over positions or mounting heights located on mechanical or electrical Drawings.
- .9 Later dated documents shall govern over earlier documents of the same type.

#### **1.5. SPECIFICATION GRAMMAR**

- .1 Specifications are written in the imperative command mode, in an abbreviated form.
- .2 Imperative language of the technical sections is always directed to the Contractor identified as a primary constructor, as sole executor of the Contract, unless specifically noted otherwise.
  - .1 This form of imperative command mode statement requires the primary constructor to perform such action or Work.
  - .2 Perform all requirements of the Contract Documents whether stated imperatively or otherwise.
- .3 Division of the Work among subcontractors, suppliers, or others is solely the prime contractor's responsibility. The Consultant(s) and specification authors assume no responsibility to function or act as an arbiter to establish subcontract scope or limits between sections or divisions of Work.

**END OF SECTION**

## **01 21 00 – Allowances**

### **1.0 GENERAL**

#### **1.1. RELATED SECTIONS**

- .1 Section 01 45 00 – Quality Control.
- .2 This Section describes requirements applicable to all Sections within Divisions 02 to 49.

#### **1.2. GENERAL**

- .1 Allowances included herein are for items of Work which could not be fully quantified prior to Bidding.
- .2 Expend each allowance as directed by the Consultant. Work covered by allowances shall be performed for such amounts and by such persons as directed by Consultant.
- .3 Funds will be expended by means of Cash Allowance allocations and contingency allowance allocations.
- .4 Progress payments for Work and Products authorized under allowances will be made in accordance with the payment terms set out in the Conditions of the Contract.
- .5 The Contractor shall bid the work involved and submit the Bids received to the Consultant and the Board, for approval
- .6 The Contractor shall submit 3 bids unless directed by the Board.

#### **1.3. CASH ALLOWANCES**

- .1 Cash allowances, cover the net cost to the Contractor of services, products, construction machinery and equipment, freight, handling, unloading, storage, installation where indicated, and other authorized expenses incurred in performing the Work. Cash allowances shall not be included by a subcontractor in the amount for their subcontract work.
- .2 Supply only allowances shall include:
  - .1 Net cost of Products.
  - .2 Delivery to Site.
  - .3 Applicable taxes and duties, excluding HST.
- .3 Supply and install allowances shall include:
  - .1 Net cost of Products.
  - .2 Delivery to Site.
  - .3 Unloading, storing, handling or products on site.
  - .4 Installation, finishing and commissioning of products.

- .5 Applicable taxes and duties, excluding HST.
- .4 Inspection and testing allowances shall include:
  - .1 Net cost of inspection and testing services.
  - .2 Applicable taxes and duties, excluding HST.
- .5 Other costs related to work covered by cash allowances are not covered by the allowance, but shall be included in the Contract Price.
- .6 Where costs under a cash allowance exceed the amount of the allowance, the Contractor will be compensated for any excess incurred and substantiated plus an allowance for overhead and profit as set out in the Contract Documents.
- .7 Progress payments on accounts of work authorized under cash allowances shall be included in the monthly certificate for payment.
- .8 Submit, before application for final payment, copies of all invoices and statements from suppliers and subcontractors for work which has been paid from cash allowances.

**1.4. ALLOWANCES SCHEDULE**

Include in the Bid Price a cash allowance of to address the cost of the following items:

1	Designated Substance Removal: (Additional removal not already identified in the ACM Summary report)	\$10,000.00
2	Testing and Inspection:	\$5,000.00
3	Roof Tie-Ins for new HVAC Units:	\$25,000.00
4	Supply and Installation of Furnishings:	\$20,000.00
5	Supply and Installation of Welding Booths:	\$35,000.00
6	Refurbishment of Existing Changeair Unit Ventilator by Systemair:	\$10,000.00
7	Removal of redundant above ceiling services/ wiring, and rework of existing mechanical to suit newly exposed ceilings:	\$30,000.00
8	Supply and Installation of Data/ Voice Cabling Installation, Public Address and Network Equipment (Including terminations)	\$20,000.00
9	Supply and Installation of Assistive Listening Equipment	\$5,000.00
10	Supply and Installation of Audio/ Video Equipment:	\$5,000.00
<b>Total of All Allowances:</b>		<b>\$165,000.00</b>

**END OF SECTION**

## **01 31 00 – Project Managing and Coordination**

### **1.0 GENERAL**

#### **1.1. RELATED SECTIONS**

- .1 Section 01 32 00 - Construction Progress Documentation.
- .2 Section 01 33 00 - Submittal Procedures.
- .3 Section 01 53 00 – Temporary Construction Facilities
- .4 Section 01 61 00 – Product Requirements
- .5 Section 01 78 10 – Closeout Submittals and Requirements
- .6 This Section describes requirements applicable to all Sections within Divisions 02 to 49.

#### **1.2. PROJECT COORDINATION**

- .1 Perform coordination of progress schedules, submittals, use of site, temporary utilities, construction facilities and construction Work, with progress of Work of other contractors, under instructions of the Consultant.
- .2 The Contractor shall have total control of the Work and shall effectively direct and supervise the Work so as to ensure conformity with the Contract Documents and within the Contract Time.
- .3 The Contractor shall be solely responsible for the construction means, methods, sequences, and procedures and for coordinating parts of the Work under the contract.
- .4 Coordinate progress of the Work, progress schedules, submittals, use of site, temporary utilities, construction facilities, safety regulations and fire protection, as per authorities having jurisdiction codes.
- .5 The Consultant has the authority to stop the Work:
  - .1 whenever they observe or are made aware of unsafe conditions.
  - .2 whenever it is deemed necessary to protect the interests of the Board,
  - .3 whenever materials or workmanship are in contravention to the Contract Documents.

#### **1.3. SITE SUPERVISOR AND PROJECT MANAGER**

- .1 If requested, the Contractor shall provide the Consultant, in writing, the name of the Project Manager and Site Supervisor, and proof of competent experience in similar projects.

- .2 Performance of the Contractors Project Manager and Site Supervisor
  - .1 If the Board and or the Consultant become concerned with any of: Site Safety, Project Schedule, or general compliance with the tender documents due to the performance of the Site Supervisor or Project Manager, the Consultant and or the Board will identify the concerns in writing to the Contractor.
  - .2 The Contractor shall respond in writing to the Board and Consultant with a corrective action for each item within 24 hours.
  - .3 If it is found that any of the corrections are not immediately implemented, the Consultant and the Board shall meet with the General Contractor to review the credentials including curriculum vitae and comparable experience of a replacement Site Supervisor and or Project Manager proposed by that Contractor.
  - .4 All outstanding concerns initiating the replacement of the personnel will be immediately addressed to the satisfaction of the Consultant and the Board.
- .3 If the Board and or the Consultant become concerned with site safety, project schedule or general compliance with the tender documents due to the performance of the Site Supervisor or the Project Manager, the Consultant or the Board will issue the concerns in writing to the Contractor. The Contractor shall respond in writing within 24 hours to the Consultant and the Board. If any of the corrections are not immediately implemented, the Consultant or the Board will schedule a meeting with the Consultant, General Contractor and the Board. At this meeting the Contractor will introduce the new Project Manager, and or Site Supervisor and present the Curriculum Vitae for each showing proof of comparable experience in similar projects. The Contractor will then address the outstanding concerns to the satisfaction of the Consultant and the Board.
- .4 The Project Manager, and/or Site Supervisor shall not be replaced by the Contractor without prior written approval from the Board and the Consultant.

#### **1.4. PERMITS**

- .1 **The Board will obtain & pay for all building permits, but the Contractor is responsible for all other permits, including electrical inspection and fire alarm verification.**

#### **1.5. CONSTRUCTION DOCUMENTS**

- .1 The Consultant will provide the Contractor with PDF copies of both the drawings and the specification and CAD format files of the drawings at no charge to the Contractor. All printing will be at the cost of the Contractor including the AS-BUILT documents.

## **1.6. PRE-CONSTRUCTION MEETING**

- .1 Immediately prior to construction and upon notification by the Consultant of a time and date, the Contractor shall attend the preconstruction meeting at a location as determined by the Consultant, along with authoritative representatives of certain key subcontractors as specifically indicated in the conference notice. Agenda to include following:
  - .1 Appointment of official representative of participants in Work.
  - .2 Project communications procedures
  - .3 Schedule of Work, progress scheduling (including long lead items, cash allowance items) as specified in Section 01 32 00.
  - .4 Schedule of submission of shop drawings, samples, colour chips as specified in Section 01 33 00.
  - .5 Requirements for temporary facilities, washrooms, refuse bin, site sign, offices, storage sheds, utilities, fences as specified in Section 01 53 00.
  - .6 Delivery schedule of specified equipment as specified in Section 01 61 00.
  - .7 Proposed changes, change orders, procedures, approvals required, mark-up percentages permitted, time extensions, overtime, and administrative requirements.
  - .8 Owner furnished products.
  - .9 Record drawings as specified in Section 01 78 10.
  - .10 Maintenance material and data as specified in Section 01 78 10.
  - .11 Take-over procedures, acceptance, and warranties as specified in Section 01 78 10.
  - .12 Monthly progress claims, administrative procedures, photographs, and holdbacks.
  - .13 Appointment of inspection and testing agencies
  - .14 Insurances and transcript of policies.
  - .15 Review Vendor Performance Evaluation for the Contractor and Subcontractors
  - .16 Hot Work Permit Process
  - .17 Security Access, Fire Alarm shutdown procedures
  - .18 Any other items as required by the owner, contractor, or Consultant.

## **1.7. ON-SITE DOCUMENTS**

- .1 Maintain at job site at all times, one copy (written or digital) each of the following:
  - .1 Complete set of Contract drawings.
  - .2 Specifications.
  - .3 All Addenda.



- .4 Site Instructions and Sketches
- .5 Reviewed shop drawings and samples.
- .6 Change Orders and Contemplated Change Orders.
- .7 Other modifications to Contract.
- .8 Site Instructions
- .9 Colour schedule
- .10 Hardware List
- .11 Field test reports.
- .12 Copy of approved Work schedule.
- .13 Manufacturers' installation and application instructions.
- .14 Progress reports and meeting minutes.
- .15 Approved building permit documents.
- .16 Copy of current Ontario Building Code and National Building Code.
- .17 CSA Standard, CGSB Specifications. ASTM Documents and other standards referenced to in the specifications.
- .18 Labour conditions and wage schedules.
- .19 Applicable current editions of municipal regulations and by-laws. Current building codes, complete with addenda bulletins applicable to the Place of the Work.

#### **1.8. SCHEDULES**

- .1 Within three weeks following the award of the Contract, submit a detailed, trade by trade progress schedule for the work in a bar chart form acceptable to the Consultant.
- .2 Submit preliminary construction progress schedule as specified in Section 01 32 00 to Consultant coordinated with Consultant's project schedule.
- .3 After review, revise and resubmit schedule to comply with revised project schedule.
- .4 During progress of Work revise and resubmit as directed by the Consultant.
- .5 Provide schedule updates every month with request for Payment, for duration of Contract.

#### **1.9. CONSTRUCTION PROGRESS MEETINGS**

- .1 Prior to the commencement of the Work, the Contractor together with the Consultant shall mutually agree to a sequence for holding regular "on site meetings".
- .2 The Contractor will organize site meetings. Ensure persons, whose presence is required, are present and relative information is available to allow meetings to be conducted efficiently.

- .3 Contractor, major subcontractors and consultants involved in Work are to be in attendance.
- .4 Post and forward copies of progress schedules for advice of Subcontractors, Owner and Consultant.
- .5 Notify parties minimum five (5) days prior to meetings.
- .6 Record minutes of meetings and circulate to attending parties and affected parties not in attendance within two (2) days after meeting.
- .7 Agenda to include following:
  - .1 Review, approval of minutes of previous meeting.
  - .2 Review of Work progress since previous meeting.
  - .3 Field observations, problems, conflicts.
  - .4 Problems which impede construction schedule.
  - .5 Review of off-site fabrication delivery schedules.
  - .6 Corrective measures and procedures to regain projected schedule.
  - .7 Revision to construction schedule.
  - .8 Progress schedule, during succeeding work period.
  - .9 Review submittal schedules: expedite as required.
  - .10 Maintenance of quality standards.
  - .11 Review proposed changes for effect on construction schedule and on completion date.
  - .12 Review site security issues.
  - .13 Other business.
- .8 Schedule additional meetings, to expedite progress, should work require it.
- .9 Keep Owner and Consultant informed of progress, of delays and potential delays during all stages of Work. Do everything possible to meet progress schedule
- .10 Schedule and administer pre-installation meetings when specified in sections and when required to coordinate related or affected Work.

#### **1.10. SUBMITTALS**

- .1 Prepare and issue submittals to Consultant for review.
- .2 Submit preliminary Shop Drawings, product data and samples for review for compliance with Contract Documents; for field dimensions and clearances, for relation to available space, and for relation to Work of other contracts. After review, revise and resubmit for transmittal to Consultant.
- .3 Submit requests for payment for review, and for transmittal to Consultant.
- .4 Submit requests for interpretation of Contract Documents, and obtain instructions through Consultant.

- .5 Process substitutions through Consultant.
- .6 Process change orders through Consultant.
- .7 Deliver closeout submittals for review and preliminary inspections, for transmittal to Consultant.

**1.11. RECORD (AS-BUILT) DOCUMENTS AND SAMPLES**

- .1 Procedures for record as-built documents and samples as specified in Section 01 78 10.
- .2 Keep as-built documents and samples available for inspection by the Consultant.

**1.12. CLOSEOUT PROCEDURES**

- .1 Take-over procedures, acceptance, and warranties as specified Section 01 78 10
- .2 Notify Consultant and Board when Work is considered ready for Substantial Performance.
- .3 Accompany Consultant and Board on preliminary inspection to determine items listed for completion or correction.
- .4 Comply with Consultant's instructions for correction of items of Work listed in executed certificate of Substantial Performance.
- .5 Notify Consultant of instructions for completion of items of Work determined in Consultant's final inspection.

**END OF SECTION**

## **01 32 00 – Construction Progress Documentation**

### **1.0 GENERAL**

#### **1.1. RELATED SECTIONS**

- .1 Section 01 33 00 - Submittal Procedures.
- .2 This Section describes requirements applicable to all Sections within Divisions 02 to 49.

#### **1.2. SCHEDULES**

- .1 Within seven 7 days following the award of the Contract, submit a detailed cash flow chart broken down on a monthly basis, in a manner acceptable to the Consultant. Cash flow chart shall indicate anticipated Contractor's monthly progress billings from commencement of work until completion.
- .2 Update cash flow chart whenever changes occur to scheduling and in manner and at times satisfactory to Consultant.
- .3 Submit schedule of values at least fourteen (14) days before the first application
- .4 Submit schedules as follows:
  - .1 Submittal Schedule for Shop Drawings and Product Data.
  - .2 Submittal Schedule for Samples.
  - .3 Submittal Schedule for timeliness of Owner-furnished Products.
  - .4 Product Delivery Schedule.
  - .5 Cash Allowance Schedule for acquiring Products and Installation.
  - .6 Shutdown or closure activity.

#### **1.3. CONSTRUCTION PROGRESS SCHEDULING**

- .1 Submit initial schedule to the Consultant and the Board in duplicate within seven (7) days after following the award.
- .2 Schedule Format.
  - .1 Prepare schedule in form of a horizontal bar chart.
  - .2 Split horizontally for projected and actual performance.
  - .3 Provide horizontal time scale identifying each Working Day of each week.
- .3 Schedule Submission.
  - .1 Consultant will review schedule and return reviewed copies within five (5) days after receipt.
  - .2 Submit schedules in electronic format, forward to the Consultant and Owner as a pdf. file.

- .3 Resubmit finalized schedule within five (5) days after return of review copy.
- .4 Submit revised progress schedule with each application for payment.
- .5 Distribute copies of revised schedule to:
  - .1 Job site office.
  - .2 Subcontractors.
  - .3 Other concerned parties.
- .6 Instruct Consultant to report to Contractor within ten (10) days, any problems anticipated by timetable shown in schedule.
- .4 Submit revised schedules with Application for Payment, identifying changes since previous version.
- .5 Select either of the following paragraphs to identify the type and format of schedule required.
- .6 Show complete sequence of construction by activity, identifying Work of separate stages and other logically grouped activities. Indicate the early and late start, early and late finish, float dates, and duration.
- .7 Indicate estimated percentage of completion for each item of Work at each submission.
- .8 Indicate submittal dates required for shop drawings, product data, samples, and product delivery dates, including those furnished by Owner and required by Allowances.
- .9 Include dates for commencement and completion of each major element of construction:
  - .1 Site clearing.
  - .2 Site utilities.
  - .3 Foundation Work.
  - .4 Structural framing.
  - .5 Subcontractor Work.
  - .6 Equipment Installations.
  - .7 Finishes.
- .10 Indicate projected percentage of completion of each item as of first day of month.
- .11 Indicate progress of each activity to date of submission schedule.
- .12 Indicate changes occurring since previous submission of schedule:
  - .1 Major changes in scope.
  - .2 Activities modified since previous submission.
  - .3 Revised projections of progress and completion.
  - .4 Other identifiable changes.

- .13 Provide a written report to define:
  - .1 Problem areas, anticipated delays, and impact on schedule.
  - .2 Corrective action recommended and its effect.
  - .3 Effect of changes on schedules of other subcontractors.

**1.4. PROGRESS PHOTOGRAPHS**

- .1 Digital Photography:
  - .1 Submit electronic copy of progress photographs of project, Digital format, minimum 300 in megapixel resolution.
  - .2 Identification: Name and number of project and date of exposure indicated.
  - .3 Provide both interior and exterior photographs.
  - .4 Number of Viewpoints: Locations of viewpoints determined by Consultant.
  - .5 Frequency: Monthly with progress statement. Provide the required number of pictures to accurately reflect the submitted progress percentage.

**1.5. SHOP DRAWING SUBMITTAL SCHEDULE**

- .1 Include schedule for submitting shop drawings, product data, samples
- .2 Indicate dates for submitting, review time, resubmission time, and last date for meeting fabrication schedule.
- .3 Include dates when shop drawings and samples will be required for Owner-furnished products.
- .4 Include dates when reviewed submittals will be required from Consultant.
- .5 Provide final signed off copies of the shop drawings in digital format to the Board.

**END OF SECTION**

## **01 33 00 – Submittal Procedures**

### **1.0 GENERAL**

#### **1.1 RELATED SECTIONS**

1. Section 01 32 00 - Construction Progress Documentation.
2. Section 01 78 10 - Closeout Submittals.
3. This Section describes requirements applicable to all Sections within Divisions 02 to 49.

#### **1.2 ADMINISTRATIVE**

1. Submit to Consultant submittals listed for review. Submit with reasonable promptness and in orderly sequence so as to not cause delay in Work. Failure to submit in ample time is not considered sufficient reason for an extension of Contract Time and no claim for extension by reason of such default will be allowed.
2. Work affected by submittal shall not proceed until review is complete.
3. Present Shop Drawings, product data, samples and mock-ups in Metric (SI) units. Shop drawings containing imperial measurements will be rejected.
4. Where items or information is not manufactured or produced in SI Metric units, converted values within the metric measurement to the next largest imperial size available. Tolerances of .0625 acceptable.
5. Review submittals prior to submission to Consultant. This review represents that necessary requirements have been determined and verified, or will be, and that each submittal has been checked and co-ordinated with requirements of Work and Contract Documents.
6. Submittals not stamped, signed, dated, identified as to specific project, and attesting to their being reviewed will be returned without being examined and shall be considered rejected.
7. Shop drawings which require the approval of a legally constituted authority having jurisdiction shall be submitted by Contractor to such authority for approval. Such shop drawings shall receive final approval of authority having jurisdiction before Consultant's final review.
8. No work, requiring a shop drawing submission, shall be commenced until the submission has received Consultant's final review. Only shop drawings bearing Consultant's review stamp are to be sent and used on the job site.
9. Notify Consultant, in writing at time of submission, identifying deviations from requirements of Contract Documents stating reasons for deviations.

10. Shop drawings shall not contain substituted materials unless such substitutions have been requested in advance and approved by Consultant.
11. Verify field measurements and affected adjacent Work are coordinated.
12. Contractor's responsibility for errors and omissions in submission is not relieved by Consultant's review of submittals.
13. Contractor's responsibility for deviations in submission from requirements of Contract Documents is not relieved by Consultant review.
14. Keep one (1) reviewed copy of each submission on site.

### **1.3 SHOP DRAWINGS AND PRODUCT DATA**

- .1 The term "Shop Drawings" means drawings, diagrams, illustrations, schedules, performance charts, brochures and other data which are to be provided by Contractor to illustrate details of a portion of Work.
- .2 The term "design team" means Consultant and Sub-consultants whether Sub-consultants are employees of Consultant or not, and includes structural, mechanical, electrical, etc.
- .3 Indicate materials, methods of construction and attachment or anchorage, erection diagrams, connections, explanatory notes and other information necessary for completion of Work. Where articles or equipment attach or connect to other articles or equipment, indicate that such items have been coordinated, regardless of Section under which adjacent items will be supplied and installed. Indicate cross references to design drawings and specifications.
- .4 Allow fourteen (14) days for Consultant's review of each submission.
- .5 Adjustments made on Shop Drawings by Consultant are not intended to change Contract Price. If adjustments affect value of Work, state such in writing to Consultant prior to proceeding with Work.
- .6 Make changes in Shop Drawings as Consultant may require, consistent with Contract Documents. When resubmitting, notify Consultant in writing of any revisions other than those requested.
- .7 Accompany submissions with transmittal letter, containing:
  - .1 Date.
  - .2 Project title and number.
  - .3 Contractor's name and address.
  - .4 Identification and quantity of each shop drawing, product data and sample.
  - .5 Other pertinent data.
- .8 Submissions shall include:
  - .1 Date and revision dates.



- .2 Project title and number.
- .3 Name and address of:
  - .1 Subcontractor.
  - .2 Supplier.
  - .3 Manufacturer.
- .4 Contractor's stamp, signed by Contractor's authorized representative certifying approval of submissions, verification of field measurements and compliance with Contract Documents.
- .5 Details of appropriate portions of Work as applicable:
  - .1 Fabrication.
  - .2 Layout, showing dimensions, including identified field dimensions, and clearances.
  - .3 Setting or erection details.
  - .4 Capacities.
  - .5 Performance characteristics.
  - .6 Standards.
  - .7 Operating weight.
  - .8 Wiring diagrams.
  - .9 Single line and schematic diagrams.
  - .10 Relationship to other parts of the Work.
- .9 After Consultant's review, distribute copies.
- .10 Submit Shop Drawings in Pdf. format for each requirement requested in specification Sections and as consultant may reasonably request.
- .11 Submit product data sheets or brochures in Pdf. format for requirements requested in specification sections and as requested by Consultant where Shop Drawings will not be prepared due to standardized manufacture of product.
- .12 Delete information not applicable to project.
- .13 Supplement standard information to provide details applicable to project.
- .14 If upon review by Consultant, no errors or omissions are discovered or if only minor corrections are made, the drawings will be stamped as reviewed or reviewed as modified and will be returned. At this point fabrication and installation of Work may proceed. If Shop Drawings are rejected, noted copy will be returned and re-submission of corrected Shop Drawings, through same procedure indicated above, must be performed before fabrication and installation of Work may proceed.
- .15 Signed drawings shall be returned to and retained by Contractor who is then responsible for distribution of copies of corrected shop drawing to appropriate

Subcontractors for appropriate action and to municipal building department for their records of those subjects required by authorities.

- .16 The Consultant's review is for the sole purpose of ascertaining conformance with the general design concept. This review shall not mean the Consultant approves the detail design inherent in the shop drawings, responsibility for which shall remain with the Contractor submitting same, and this review shall not relieve the Contractor of his responsibility for meeting the requirements of the Contract Documents. The Contractor is responsible for dimensions to be confirmed and correlated at the job site for information that pertains solely to fabrication processes or to techniques of construction and installation and for coordination of the work of all subtrades.

#### **1.4 SAMPLES**

- .1 Submit for review to the Consultant three (3) samples as requested in respective specification Sections.
- .2 Submit samples with identifying labels bearing material or component description, manufacturer's name and brand name, Contractor's name, project name, location in which material or component is to be used, and date.
- .3 Deliver samples prepay any shipping charges involved for delivering samples to destination point and returning to point of origin if required.
- .4 Provide samples of special products, assemblies, or components when so specified.
- .5 No work requiring a sample submission shall commence until submission has received Consultant's final review.
- .6 Notify Consultant in writing, at time of submission of deviations in samples from requirements of Contract Documents.
- .7 Where colour, pattern or texture is criterion, submit full range of samples.
- .8 Adjustments made on samples by Consultant are not intended to change Contract Price. If adjustments affect value of Work, state such in writing to Consultant prior to proceeding with Work.
- .9 Make changes in samples which Consultant may require, consistent with Contract Documents.
- .10 Reviewed and accepted samples will become standard of workmanship and material against which installed Work will be verified.

#### **1.5 MOCK-UP**

- .1 Erect mock-ups to Section 01 45 00.

**1.6 CERTIFICATES AND TRANSCRIPTS**

- .1 Immediately after award of Contract, and prior to commencing the work submit the performance bond and the labour and materials payment bond as described in the bid documents.
- .2 Submit transcription of certified true copies of insurance immediately after award of Contract.
- .3 A current WSIB clearance certificate
- .4 The bidder's health and safety policy for the project.
- .5 A copy of the notice of project issued by the ministry of labour for the project
- .6 Building materials, components and elements specified without the use of trade or proprietary names shall meet requirements specified. If requested by Consultant, submit evidence of meeting requirements specified. Evidence shall consist of certification based on tests carried out by an independent testing agency. Certification based on previous tests for same materials, components or elements is acceptable. Certification shall be in form of written test reports prepared by testing agency.

**END OF SECTION**

## **01 35 17 – Fire Safety Procedures**

### **1.0 GENERAL**

#### **1.1. RELATED SECTIONS**

- .1 Section 01 14 00 – Work Restrictions.
- .2 Section 01 31 00 - Project Managing and Coordination.
- .3 Section 01 33 00 - Submittal Procedures.
- .4 Section 01 35 23 – Health and Safety
- .5 This Section describes requirements applicable to all Sections within Divisions 02 to 49.
- .6 Appendix 01 35 17A Contractor Hot Work Permit

#### **1.2. FIRE SAFETY PLAN**

- .1 Contractors and their personnel will be familiar with this section and its requirements.
- .2 The contractor must take all necessary precautions during the carrying out of the work to prevent the possibility of fire occurring.

#### **1.3. FIRE PROTECTION**

- .1 Provide and maintain temporary fire protection equipment during performance of Work required by the governing codes, regulations and bylaws.
- .2 The contractor will, at all times, when welding, brazing and performing any operation with an open flame, combustible adhesives or flammable solvents keep a portable, operable fire extinguisher within 3 meters of the operation.

#### **1.4. HOT WORK**

- .1 Take all precautions to Work safely and to provide the necessary protection to persons and property from Hot Work. This includes, but is not limited to Brazing, Cutting, Grinding, Soldering, Thawing Pipe, Torch Applied Roofing and Welding. With all such activity these steps are to be followed:
  - .1 Whenever possible, complete Hot Work in a welding shop or out of doors at the school.
  - .2 Flammable liquids, dust lint and oily deposits to be removed from within 50-ft (15m) of Work. Remove other combustibles where possible. Otherwise protect with fire-resistive tarpaulins or metal shields.

- 
- .3 Explosive atmosphere in area eliminated. Floors swept clean. Combustible floors wet down, covered with damp sand or fire-resistive tarpaulins.
  - .4 All wall and floor openings covered. Fire-resistive tarpaulins suspended beneath Work.
  - .5 For on-site Work (indoor and out of doors), advise the Head Custodian, Principal, Consultant (if assigned) and Project Coordinator prior to Work being performed, and of related dangers.
  - .6 Where the Fire Alarm system is required to be set to stand-by to discourage false alarms from smoke detectors provide a firewatch throughout the building or structure being worked on. NEVER put the fire alarm system in stand-by mode when the building is occupied by staff or students.
  - .7 In the event of a fire as a result of the Hot Work, notify the fire department immediately. Report incident to the head custodian, the Consultant, if assigned, and Project Coordinator immediately, whether extinguished or not. Provide a fire incident report to the Board.
  - .8 Barriers must be set up to protect staff and students (i.e. pylons, shields, and caution tape) from exposure to arc flash and smoke migration.
  - .9 Have all necessary doors, windows and/or drapes closed. Confer with the Head Custodian to shut down all fan systems in the area to reduce or eliminate smoke distribution.
  - .10 Provide and keep fire extinguishers handy and in good Working condition. Temporarily cover all smoke detectors in the area during time of Work.
  - .11 Provide a fire watch/spot check for several hours after Work is completed. Uncover smoke detectors.
  - .12 On new construction, the requirements of the Hot Wok permit may be waived, until such time as either Substantial Completion or Occupancy is granted, whichever comes first.
  - .13 On additions to existing buildings, the requirements for Hot Work permits shall remain in place.

#### **1.5. HOT WORK PERMIT**

- .1 **A sample Hot Work Permit is attached to the specifications – refer to attached Appendix 01 35 17-A**
- .2 Each permit is valid for seven (7) days only and must be renewed prior to its expiration date
- .3 The contractor must obtain Hot Work Permits from the School Board's representative prior to the start of work.

- .4 The contractor must complete the form as required and must keep the form on site.
- .5 Return each completed form to the School Board's representative on the date of expiration.
- .6 The most current version of the Permit and its requirements shall be used for the purposes of the Work.

#### **1.6. FIRE PROTECTION SYSTEMS**

- .1 Any Modifications to Fire Alarm system and its devices including service, additions and changes in device location must be performed only by a Certified Fire Alarm Technician as per the Ontario Fire Code section 1.1, subsection 1.1.5.
- .2 The Contractor will receive from the Board's contact a contact number for the monitoring service and a school system number.
- .3 Bidders are cautioned that the Board will be reimbursed for the cost of false alarms. Refer to Section 01 14 00 Work Restrictions, Para. 1.4.4.
- .4 An approved inspection firm shall verify all new fire alarm devices, in accordance with CSA regulations. Certificate of Verification is required before occupancy.

#### **1.7. FIRE ALARM SHUT-DOWN PROCEDURE**

- .1 Plan the operation such that the required work minimizes system down time to the least amount possible. Do not shut the system down or engage silence mode when the building is occupied by students. Only shut the system down when necessary.
- .2 For the purposes of this section, unoccupied shall mean when the school is not occupied by students.
- .3 Wherever possible, shut down only the zone needing work,
- .4 and schedule down time in unoccupied school hours.
- .5 Contractor(s) shall ensure all costs are included in their bid price for work related to the fire alarm system outside of regular hours and/or during unoccupied school hours. This shall include evening and weekend work.
- .6 A fire alarm system must remain active when the building is not occupied by school or contractor's forces and should never be offline overnight.
- .7 Procedure

The following procedure shall be followed when a fire alarm system is completely or partially affected by maintenance, shutdown, bypass, silence, loss of power, or any other nomenclature that affects the proper operation of the complete system.

- .1 Inform both the principal and head custodian whenever the fire alarm system is to be disabled prior to any partial or whole system shut down. Where

- school staff are not available, ensure that the Project Coordinator and/or area supervisor are informed.
- .2 Ensure that the school or building administration has advised all staff when the fire alarm system is disabled and/or when it is back online. This will include instructions to call 911 if they detect smoke or a fire.
  - .3 Immediately prior to alarm system shutdown and upon restoring the fire alarm system, the person supervising the shutdown must:
    - .1 obtain the school account number, located on a red decal attached to the fire alarm panel. This number will be formatted as 20-9xxx, with the xxx being the school location code,
    - .2 contact Direct Detect at 519-741-2494 (the fire alarm monitoring company), to inform them of the state of the fire alarm and the approximate amount of time the fire alarm will be offline. They will require the building name and account number, the contact name, the contractor name as well as any other information they request, and
    - .3 contact Bestell at 519-741-2494 (the current security monitoring company), to inform them of the state of the fire alarm and the approximate amount of time the fire alarm will be offline. They may require the building name and account number as well as any other information they request.
  - .4 A fire watch, at the Contractor's expense, shall be undertaken by a person with the sole and express purpose of completing the following tasks and in the event of the detection of smoke, fire, or any other emergency, notifying the fire department, and the building occupants. The fire watch patrol shall:
    - .1 patrol all halls and high-risk areas affected,
    - .2 have access to a phone and call 911 if they see or detect smoke or fire,
    - .3 report any other problems they encounter,
    - .4 notifying the building occupants in the event of an emergency and
    - .5 remain on patrol until the fire alarm system is reactivated and fully operational.
  - .5 Contact Direct Detect, Bestell, and school administration to inform them that the fire alarm is back online.
  - .6 In the event that a fire alarm system is activated, whether by smoke, fire or accidentally, the system must not be reset until authorized by the Fire Department (verbally or in person) and the cause of the alarm has been investigated.

**1.8. FIRE PROTECTION EQUIPMENT IMPAIRMENT**

- .1 Fire Protection Equipment referred to in this section includes sprinkler systems, special fire suppression systems, and kitchen hood suppression systems.
- .2 The Contractor will take all precautions including restrict all Hot Work operations and shut down hazardous processes during all Fire protection equipment impairment.
- .3 Do not shut the Fire protection equipment down unless necessary. Plan the operation required to reduce system impairment time to the least amount possible.
- .4 Wherever possible, shut down only the Fire protection equipment needing Work and schedule this impairment time for unoccupied school hours. Allow for this in your bid pricing.
- .5 Discuss the possible down time with the head custodian and principal prior to any partial or whole system impairment.
- .6 The school administration shall advise all staff of Fire protection equipment shut down. This will include instructions to call 911 if they see a fire and when system is back online
- .7 The Contractor will plan to use temporary protection such as extra extinguishers, charged hose lines and temporary sprinkler protection during all Fire protection equipment impairment.
- .8 If the sprinkler system is restorable, either in whole or in part, the Contractor or subcontractor shall assign someone to restore the system promptly in the event of a fire.
- .9 A fire patrol may need to be established and will include the following at the Contractor's expense:
  - .1 Patrol all halls and high-risk areas affected.
  - .2 Fire patrol shall have access to a phone and call 911 if they see a fire.
  - .3 Report all other problems they encounter.
  - .4 Remain on patrol until the system is back on.
- .10 The Contractor shall inform all sub trades that the Board has a Red Tag Permit System and it shall be used for all Fire protection equipment impairment.
- .11 For ease of use, a Factory Mutual hanging wall kit has been put in place at all Board Fire protection equipment locations. Supplies of Red Tag Permits are provided there.



### **1.9. FIRE ALARM MODIFICATIONS AND MAINTENANCE**

- .1 Very important changes to Ontario Building Code as they relate to the Standard for the Verification of Fire Alarm Systems CAN/ULC-S537-M have taken effect December 24, 1999. (Minister's Ruling 99-BC-01)
  - .1 Clause 5.1; "Addition of conventional field device(s), or modification(s), to existing input circuit(s) or output circuit(s) shall require re-verification of all devices served by those input circuit(s) or output circuit(s)." If one device is added to a zone, the entire zone or in the case of a single zone panel the entire system is to be verified.
  - .2 Clause 5.2 "Addition of input circuit(s) or output circuit(s) to an existing fire alarm system shall require verification of the new circuit(s) in accordance with this standard, and shall also require all previously existing circuit(s) to be tested as follows:
    - .3 TEST: One conventional field device on each circuit shall be operated to confirm activation of all output circuits in accordance with the systems design." Even though no other zones have been touched, one device per input zone is to be tested when the Fire Alarm system is modified.
    - .4 Clause 5.5 "Where a transponder is added to an existing system, the transponder shall be verified in accordance with subsections 3.2, Wiring; and subsection 3.3 Control Units; and with CAN/ULC-S536, Standard for the Inspection and Testing of Fire Alarm Systems as well as re-verification of existing field devices and verification of new conventional field devices." If a new addressable device is added to a system, the new device is to be tested; as well a test must be conducted on all addressable devices on the loop.
    - .5 Clause 5.6 "Where an existing fire alarm system control unit is replaced with a new control unit, it shall be verified in accordance with CAN/ULC-S536, Standard for the Inspection and Testing of Fire Alarm Systems. Replacement of any control panel will require the testing of all existing fire alarm devices.
- .2 The Contractor and subcontractors shall include in the bid price for the above ULC Standards requirements referenced in the Ontario Building Code.

### **1.10. INSTALLATION AND/OR REPAIR OF ROOFING**

- .1 The Contractor will review with the Consultant and the Board's representative of the location of any asphalt kettles and the dates the kettles will be in use. The Contractor, in the course of performing roofing work, will ensure all personnel utilize the following precautions:
  - .1 Use only kettles equipped with thermometers or gauges in good working order.

- .2 Locate kettles in a safe place outside of the building.
- .3 Maintain continuous supervision while kettles are in operation and provide metal covers for the kettles to smother any flames in case of fire.
- .4 All roofing materials stored in locations no closer than 15 meters to any structures.

**1.11. FIRE DEPARTMENT ACCESS**

- .1 Designated fire routes must be maintained. The Fire Department must be advised of any work that would impede fire apparatus response.

**1.12. SMOKING PRECAUTIONS**

- .1 Smoking is not permitted anywhere on Board properties. Workers who wish to smoke must leave the property, and not within sight of students. Any worker found to be in contravention of the Ontario Smoke Free Act will be subject to legislated fines.

**1.13. FLAMMABLE LIQUIDS**

- .1 The handling and storage on site of flammable liquids are to be governed by the current National Fire Code of Canada.
- .2 Flammable liquids such as gasoline, kerosene and naphtha may be kept for ready use in quantities not exceeding 10 imperial gallons provided they are stored in approved safety cans bearing the Underwriter's Laboratory of Canada or Factory Mutual seal of approval.
- .3 Transfer of flammable liquids is prohibited within buildings.
- .4 Transfer of flammable liquids must not be carried out in the vicinity of open flame or any type of heat producing devices.
- .5 Flammable liquids having a flashpoint below 100° F (37.7°C) such as naphtha or gasoline must not be used as solvents or cleaning agents.
- .6 Flammable waste liquids, for disposal, must be stored in approved containers located in a safe ventilated area. Quantities are to be kept to a minimum.

**END OF SECTION**

**Appendix 013517-A Contractor Hot Work Permit**



Waterloo Region  
 District School Board

**Appendix - 013517-A**

Facility Services

**CONTRACTOR HOT WORK PERMIT**

**STOP!**

**Avoid hot work or seek an alternative method if possible.**

This hot work permit is required for any temporary operation involving open flames or producing heat and/or sparks. This includes but is not limited to: brazing, cutting, grinding, soldering, torch-applied roofing and welding.

**A SEPARATE PERMIT IS REQUIRED FOR EACH AREA**

- Board Supervisor/ Manager/Proj. Coordinator Responsibilities:
- Verify precautions taken in Section A
  - Complete and retain Part 1
  - Complete Section B prior to commencement of Hot Works
  - Issue Part 2 to Contractor completing Hot Work & Post
  - Obtain Part 2 when Fire Monitoring complete
  - Return Part 1 and Part 2 to Controller, Facility Services

- Contractor Responsibilities:
- Verify precautions taken in Section A
  - Complete Section C during each day that Hot Works takes place
  - Return Part 2 to Board Supervisor/ Manager/Proj. Coordinator

**PART 1**

<p><b>Section A Indicate Precautions Taken</b></p> <p><input type="checkbox"/> Available sprinklers, hose streams, and extinguishers available and in service</p> <p><b>Within 35' or 11m of hot work</b></p> <p><input type="checkbox"/> Flammable liquid, dust, lint and oily deposits removed</p> <p><input type="checkbox"/> Explosive atmosphere in area eliminated</p> <p><input type="checkbox"/> Floors swept clean</p> <p><input type="checkbox"/> All wall and floor openings covered</p> <p><input type="checkbox"/> Combustible floors covered with fire resistant sheets</p> <p><input type="checkbox"/> Protect or shut down ducts that might carry sparks/smoke</p> <p><b>Hot work on walls, ceiling or roofs</b></p> <p><input type="checkbox"/> Construction is noncombustible and without combustible covering or insulation</p> <p><input type="checkbox"/> Combustible materials on other side of walls, ceilings or roofs moved away</p> <p><input type="checkbox"/> Combustible structure wetted down</p> <p><b>Hot work on enclosed equipment</b></p> <p><input type="checkbox"/> Enclosed equipment cleaned of all combustible material</p> <p><input type="checkbox"/> Containers purged of flammable liquid/vapour</p> <p><input type="checkbox"/> Pressurized vessels, piping &amp; equipment removed from service, isolated &amp; vented</p> <p><b>Fire watch/hot work and monitoring</b></p> <p><input type="checkbox"/> Fire watch will be provided <u>during</u> and for <u>1 hour</u> after work including break</p> <p><input type="checkbox"/> Fire watch is trained and supplied with suitable extinguishers</p> <p><input type="checkbox"/> Fire watch is trained in the use of sounding fire alarm</p> <p><input type="checkbox"/> Fire watch conducted in adjoining areas, above and below the space where appropriate</p> <p><input type="checkbox"/> Multiple hot work areas for an additional <u>2 hours</u> after fire watch</p> <p><input type="checkbox"/> Other precautions taken (please detail):</p> <p>_____</p> <p>_____</p> <p>_____</p> <p>_____</p>	<p><b>Section B Authorization Granted</b></p> <p>Board Supervisor/Manager/Proj. Coordinator: _____</p> <p style="text-align: right;">Print Name                      Signature</p> <p>Permit Valid from / to: (max. 7 days)                      _____</p> <p style="text-align: right;">From This Date                      To This Date</p> <p style="text-align: center;">(Maximum 7 days or until end of hot work whichever is sooner)</p>
---	--

<b>Section C Contractor and Location Affected</b>			
Dates: (max 7 days)	Name of Contractor conducting hot work	Name & signature of individual assigned to fire watch	Name & signature of individual assigned to fire monitoring
School: _____ Rooms/Area: _____ Nature of Job: _____ I verify the above location has been examined <u>each day</u> , the precautions listed in Section A have been taken <u>each day</u> , and permission is authorized for this work. I further acknowledge that if activity is during <u>school operational hours</u> , that appropriate <u>notification</u> has been given to <u>school</u> administration. Hot Works Contractor: _____ Signature School Administrator notified: _____ Print Name In Case of Emergency call: 911 - Then call: 519-570-0003 Ext. 4123			

Refer to WRDSB Administration Procedure 1200 Hot Works/Fire Watch (Copies Available on Request)

## **01 35 23 – Health And Safety**

### **1.0 GENERAL**

#### **1.1. RELATED SECTIONS**

- .1 Section 01 31 00 - Project Managing and Coordination.
- .2 Section 01 33 00 - Submittal Procedures.
- .3 Section 01 35 17 – Fire Safety Requirements
- .4 Section 01 35 43 – Hazardous Materials
- .5 Section 01 41 00 – Regulatory Requirements
- .6 Section 01 53 00 – Temporary Construction Facilities
- .7 This Section describes requirements applicable to all Sections within Divisions 02 to 49.

#### **1.2. REFERENCES**

- .1 Province of Ontario, including requirements for a "Prime Contractor" as defined by the Act.

#### **1.3. SAFETY PLAN**

- .1 Develop written site-specific Health and Safety Plan based on hazard assessment prior to commencing any site Work and continue to implement, maintain, and enforce plan until final demobilization from site. The Health and Safety Plan must address project specifications.
- .2 Consultant may respond in writing, where deficiencies or concerns are noted and may request resubmission with correction of deficiencies or concerns.
- .3 Be governed by pertinent safety requirements of Federal or Provincial Governments and of municipal bodies having authority, particularly the Ontario Construction Safety Act, The Occupational Health and Safety Act for Ontario, and regulations of Ontario Ministry of Labour, and work in conjunction with proper safety associations operating under the authority of Ontario Workers' Compensation Act. Protect Owner, Owner's employees, the public and those employed on the Work from bodily injury and to protect adjacent public and private property and Owner's property from damage. Furnish and maintain protection, such as warning signs, tarpaulins, guard rails, barriers, guard lights, night lights, railings around shafts, pits and stairwells, etc. as required. Remove temporary protective measures when no longer required.

**1.4. TEMPORARY WORK**

- .1 Temporary work requiring engineering proficiency for the design, erection, operation maintenance and removal shall be designed and bear the stamp of the registered professional Engineer or Architect. Detail drawings will be submitted to the Consultant for review prior to commencing any work.
- .2 Before a temporary structure is used, the person responsible for design, or their representative, shall inspect the structure and certify it has been constructed according to their design.

**1.5. RESPONSIBILITY**

- .1 The "Prime Contractor" according to applicable local jurisdiction, is responsible for health and safety of persons on site, safety of property on site and for protection of persons adjacent to site and environment to the extent that they may be affected by conduct of Work.
- .2 Comply with and enforce compliance by employees with safety requirements of Contract Documents, applicable federal, provincial, territorial and local statutes, regulations, and ordinances, and with site-specific Health and Safety Plan.
- .3 Should any unforeseen or peculiar safety-related factor, hazard, or condition become evident during performance of Work, and follow procedures in place for Employee's Right to Refuse Work in accordance with Acts and Regulations of Health and Safety Act having jurisdiction. Advise the Board and the Consultant verbally and in writing.
- .4 The Contractor shall make their own arrangements for emergency treatment of accidents. Any accidents shall be reported immediately to the Board contact.
- .5 The Contractor agrees to hold the Board harmless of any and all liability of every nature and description, which may be suffered through bodily injuries, involving deaths of any persons, by reasons of negligence of the Contractor, his agents, employees, or his subcontractors.

**1.6. SUBMITTALS**

- .1 Make submittals in accordance with Section 01 33 00.
- .2 Submit site-specific Health and Safety Plan: Within ten (10) days after the date of Notice to Proceed and prior to commencement of Work. Health and Safety Plan must include:
  - .1 Results of site specific safety hazard assessment.
  - .2 Results of safety and health risk or hazard analysis for site tasks and operation

- .3 Submit one (1) copy of Contractor's authorized representative's work site health and safety inspection reports to Consultant and Owner.
- .4 Submit copies of reports or directions issued by Federal, Provincial and Territorial health and safety inspectors.
- .5 Submit copies of incident and accident reports.
- .6 Submit Material Safety Data Sheets (MSDS) to Consultant.
- .7 Consultant's review of Contractor's final Health and Safety plan should not be construed as approval and does not reduce the Contractor's overall responsibility for construction Health and Safety.
- .8 Medical Surveillance: Where prescribed by legislation, regulation or safety program, submit certification of medical surveillance for site personnel prior to commencement of Work, and submit additional certifications for any new site personnel to Consultant.
- .9 On-site Contingency and Emergency Response Plan: Address standard operating procedures to be implemented during emergency situations.
- .10 File Notice of Project with the Ministry of Labour prior to commencement of Work.

#### **1.7. SAFETY ACTIVITIES**

- .1 Perform site specific safety hazard assessment related to the project.
- .2 Schedule and administer Health and Safety meeting with Consultant prior to commencement of Work.
- .3 Perform Work in accordance with Section 01 41 00 - Regulatory Requirements and this Section.

#### **1.8. HEALTH AND SAFETY COORDINATOR**

- .1 Employ and assign to Work, competent and authorized representative as Health and Safety Coordinator. Health and Safety Coordinator must:
  - .1 have previous experience as a Health & Safety coordinator,
  - .2 have working knowledge of occupational safety and health regulations,
  - .3 be responsible for completing Contractor's Health and Safety Training Sessions and ensuring that personnel not successfully completing required training are not permitted to enter site to perform Work,
  - .4 be responsible for implementing, enforcing daily and monitoring site-specific Contractor's Health and Safety Plan, and
  - .5 be on site during execution of Work.

**1.9. POSTING OF DOCUMENTS**

- .1 Ensure applicable items, articles, notices and orders are posted in conspicuous location on site in accordance with Acts and Regulations of Health and Safety Act having jurisdiction, and in consultation with Consultant.

**1.10. CORRECTION OF NON-COMPLIANCE**

- .1 Immediately address health and safety non-compliance issues identified by authority having jurisdiction or by Consultant or by the Board.
- .2 Provide Consultant and/or Board with written report of action taken to correct non-compliance of health and safety issues identified.
- .3 Consultant and or the Board may stop Work if non-compliance of health and safety regulations is not corrected.

**1.11. PROJECT/SITE CONDITIONS**

- .1 Work at site will involve contact with:
  - .1 Refer to Section 01 35 43 Hazardous Materials

**1.12. HAZARDOUS WORK**

- .1 Blasting or other use of explosives is not permitted at the place of work.

**1.13. WORK STOPPAGE**

- .1 Give precedence to safety and health of public and site personnel and protection of environment over cost and schedule considerations for Work.

**1.14. LOCKOUT PROCEDURES**

- .1 All Work to be done on electrical systems or machinery, where the unexpected switching on of the system or machinery could result in personal injury to a student, staff, employee, or the Contractor's employee, must be done in accordance with the Contractor's standard lockout procedure.
- .2 The Contractor shall provide his/her own locks for the above procedure.
- .3 The lock shall include contact information for the person(s) locking out such devices.

**1.15. OVERHEAD LIFTING**

- .1 Under no circumstances will a crane or lifting device be used over an occupied space.
- .2 When working adjacent to occupied spaces, ensure a clearance of one (empty) classroom, or a minimum of 10m between any occupied space and the furthest possible reach of the crane.

**1.16. WARNING SIGNS AND NOTICES**

- .1 Notices shall be posted advising of the hazard but will not be considered a substitute for providing approved protection, separation, and space from the hazard.

**1.17. FIRE PROTECTION**

- .1 Provide and maintain temporary fire protection equipment during performance of Work required by the governing codes, regulations and bylaws.
- .2 Burning rubbish and construction waste materials is not permitted on site.
- .3 Maintain placed or installed Fire Protection to protect the portions of the Work during construction.

**1.18. SCENT-FREE ENVIRONMENT**

- .1 The Board requires that, where advised, a building may be deemed scent-free and as such, the wearing of scented products is prohibited.
- .2 Any methods or materials that are found to create negative responses in staff or students shall cease and be removed under advisement of the Consultant and or the Board, until alternate methods can be determined.

**END OF SECTION**



## **01 35 43 – Hazardous Materials**

### **1.0 GENERAL**

#### **1.1. RELATED SECTIONS**

- .1 Section 01 35 23 – Health and Safety Requirements.
- .2 Section 01 41 00 – Regulatory Requirements.
- .3 This Section describes requirements applicable to all Sections within Divisions 02 to 49.

#### **1.2. REFERENCES**

- .1 Province of Ontario, including requirements for a "Prime Contractor" as defined by the Act.

#### **1.3. ASBESTOS and OTHER REGULATED SUBSTANCES**

- .1 An Asbestos Audit Update, as prepared by MTE Consultants Inc. for this facility, is attached under Appendix 013543 A. A duplicate set is also available in the Facilities Services Departments located in the Education Centre. Unless specifically covered by a Cash Allowance or Contingency Allowance that states otherwise, include in this Contract the required removal of all asbestos containing materials (ACM) to complete the work. No claims for extra costs will be accepted for areas known to contain ACM that are within the scope of this Work.
- .2 Comply with applicable legislation regarding asbestos. Should the Contractor encounter asbestos not noted in the referenced Asbestos Audit that would be disturbed during the course of the Work, they should stop the work in that immediate area and report the same to the Consultant and Board contact.
- .3 In addition, Lead, Mercury, Silica, and Isocyanates are anticipated to be present in existing facilities. New construction, renovations, or alterations require compliance by the Contractor with the applicable legislation.

#### **1.4. PROTOCOL FOR ABATEMENT WORK**

- .1 This Protocol establishes the requirements to be followed by all Asbestos Abatement Contractors involved with the Board. It applies to Type 1, Type 2 and Type 3 Operations as stated in the Regulations and applies to emergency and non-emergency work (directly retained or working as a sub-contractor).
- .2 Asbestos Abatement Contractors must maintain appropriate insurance coverage and WSIB certification.

- 
- .3 Contractors retained for asbestos abatement work shall use personnel certified by the Ontario College of Trades and must provide the Consultant and Board with proof of asbestos certification (AAS and AAW) for all supervisors / all staff involved.
  - .4 School Access
    - .1 During school hours all asbestos contractors are to report to the school office upon arrival. After school hours, ensure card-in / card-out procedures are followed and building security is maintained.
  - .5 Communication
    - .1 Establish communication contact list with email and phone numbers that shall include:
      - .1 Principal / Vice Principal
      - .2 Area Facility Manager
      - .3 Head Custodian
      - .4 Environmental Officer
      - .5 Manager of Mechanical, Electrical and Environmental Services
      - .6 Manager of Health Safety & Security
      - .7 Contractor staff
      - .8 Consultant
    - .2 Contact the School Principal / Vice to set up a firm date for the abatement (removal / repair). Schedule to allow at least 72 hours notice ahead of the work.
    - .3 Confirm the date by notifying via email the following:
      - .1 Principal / Vice-principal,
      - .2 Area Facility Manager, and
      - .3 Environmental Officer.
      - .4 Consultant
    - .4 Indicate the date, the start time, the anticipated completion time for the work and the work areas in the school.
    - .5 Identify personnel managing the project and provide current cell numbers for emergency contacts.
    - .6 For emergency work, as requested by Area Supervisors, Facility Managers or Environmental Officer, no notification to the school is required.
    - .7 Additionally, for Type 3 work also contact:
      - .1 Manager of Health, Safety & Security, and
      - .2 Notify the MOL (also for Type 2) where required by regulation.
      - .3 Consultant

- .8 Discussions with other groups, school staff, media and others is discouraged and shall be directed to the Board Communication Officer where warranted.
- .6 Asbestos Operations
  - .1 Emergency work shall be carried out the same day (evening/night) or under exceptional conditions the following day / evening / night. Contractors shall exercise discretion when working in the school to minimize anxiety of staff/school community. Where warranted, contact Area Supervisor, Facility Manager or Environmental Officer to obtain further direction.
  - .2 For non-emergency work, contractor is to assess the work on site and provide a cost estimate to the Environmental Officer, (daniela\_budure@wrdsb.on.ca) and Consultant. Some work will require discussion with the Facility Manager or Environmental Officer to assess if additional work should be done as to completely remove all ACM material form the area or similar.
  - .3 Where the MTE report shows ACM requiring repair, remove and re-insulate where required.
  - .4 Before beginning any Type 1, Type 2 or Type 3 Operations, the work area must be secured, doors closed, warning signs added to all entrances, caution tape used in open areas and signs used to restrict access to the work area so as to keep persons not involved in the work from entering in the work area.
  - .5 Provide “Construction” warning signs on solid barriers between the Work and public areas. Install a sufficient number of “asbestos abatement” warning signs behind the barriers, posted to warn of the hazard, and that access to the work area is restricted to persons wearing protective clothing and equipment.
  - .6 The contactor is responsible to disable the mechanical ventilation serving the work area and positively prevent operation using Lock-out / Tag-out devices for each air handling unit /fan. Exercise caution during heating season to ensure areas of the building are maintained above freezing and ensure equipment is turned back on after abatement / air clearance completed.
  - .7 Contractor’s employees shall put on / take off PPE within work area marked by construction signs. No employee shall leave the work area wearing PPE.
  - .8 All dust and waste is to be cleaned up and removed at frequent / regular intervals as the work proceeds and immediately upon completion. No waste bags or similar are to be left behind.

### **1.5. SUBMITTALS**

- .1 Once the abatement is completed, forward a Letter of Completion to the Environmental Officer, (daniela\_budure@wrdsb.on.ca). This letter shall be received no later than 72 hours after completion and shall include any sample results.
- .2 For those projects requiring Air Clearance, ensure this info is sent without delay but in all cases no later than 24 hours after sampling. All Type 3 work must take into account that the initial samples may not pass and the contactor must allow one additional day to re-clean and re-sample before school is to resume operations. For those projects not under the direct supervision of a Environmental Consultant, the contactor is to expedite the air clearance sampling with the lab of their choice and carry these costs.
- .3 Forward Air Clearance results to:
  - .1 Principal / Vice-principal,
  - .2 Facility Manager,
  - .3 Environmental Officer,
  - .4 Manager of Mechanical, Electrical and Environmental Services, and
  - .5 Manager of Health, Safety & Security.
  - .6 Consultant

### **1.6. ACKNOWLEDGEMENT**

- .1 The protocols for asbestos work must be read and understood by Asbestos Contractor.
- .2 Submit a signed copy of the most current copy of PROTOCOL FOR ABATEMENT WORK (ASBESTOS ABATEMENT CONTRACTORS) to the General Contractor, the Consultant, and the Board's Environmental Officer.

**END OF SECTION**

**Appendix 01 35 43A Asbestos Audit Update Report**



# Waterloo Oxford District Secondary School

## 2021 Asbestos Audit Update Report

**Project Location:**

1206 Snyder's Road, Baden, ON

**Prepared for:**

Waterloo Region District School Board  
51 Ardelt Avenue, Kitchener, ON

**Prepared by:**

MTE Consultants  
520 Bingemans Centre Drive  
Kitchener, ON N2B 3X9

July 13, 2021

**Revised:** October 25, 2022

**MTE File No.:** C34532-921

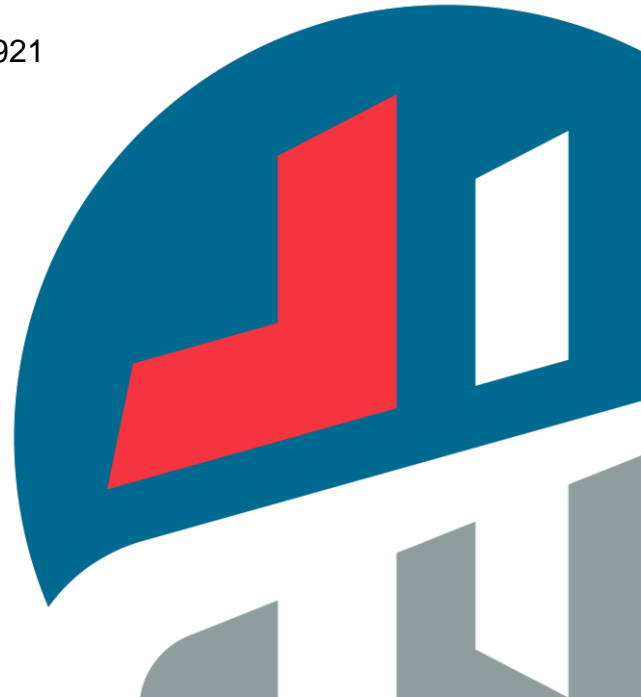



MTE Consultants

520 Bingham Centre Drive, Kitchener, Ontario N2B 3X9

July 13, 2021

**Revised:** October 25, 2022

MTE File No.: C34532-921

Waterloo Region District School Board  
51 Ardelt Avenue  
Kitchener, ON N2C 2R5

**RE: 2021 Asbestos Audit Update – Waterloo Oxford District Secondary School  
1206 Snyder’s Road, Baden, Ontario**

## 1.0 Introduction

MTE Consultants Inc. (MTE) was authorized by the Waterloo Region District School Board (WRDSB) to conduct the 2021 Asbestos Audit Update for the subject building.

The purpose of the assignment was to re-assess and document the location, type, and condition of identified asbestos-containing materials (ACM) present within the building and make appropriate recommendations for management, abatement or remedial activities, as required.

The audit was conducted in accordance with the Ontario Ministry of Labour, *Regulation 278/05- Designated Substance-Asbestos on Construction Projects and in Buildings and Repair Operations* (O. Reg. 278/05). This report shall replace previous audit reports.

## 2.0 Scope of Work

The Scope of Work for this assessment was completed by MTE and included the following activities:

- Review of existing and historical reports and documentation pertaining to ACM within the building;
- Visual inspection to assess the condition of previously identified ACM, excluding portable structures;
- Collection of building material samples that are suspect ACM, as applicable;
- Submission of samples to an accredited laboratory, as applicable;
- Photographic log of damaged materials; and
- Preparation of this report with findings and recommendations.

### 3.0 Methodology and Assessment Criteria

This inspection was conducted by visual and laboratory identification methods for the assessment of ACM and their corresponding location, use, condition, and friability. The areas outlined in Section 2.0 were inspected limited to building components, materials and service connections. Notwithstanding that reasonable attempts were made to identify all ACMs, the possibility of concealed material exists and may not become visible until substantial demolition has occurred and therefore are currently undocumented and did not include the following.

- Locations that may be hazardous to the surveyor, such as electrical equipment;
- Where invasive inspection could cause consequential damage to the property or impair the integrity of the equipment, such as roof systems, underground services or components of mechanical equipment;
- Locations concealed by building finishes that require substantial demolition or removal for access or determination of quantities;
- Materials that is present in such an inconsistent fashion that without complete removal of finishes, the extent cannot be determined;
- Non-permanent items or personal contents, furnishings; and
- Settled dust or airborne agents unless otherwise stated.

#### 3.1 Condition of ACM

During the audit process the general condition of ACMs were observed and noted. Materials which are damaged can pose an increased exposure risk to workers, building occupants and the public. While assessing damage can be subjective, abatement items were grouped into two categories to aid in remedial prioritization.

##### *Monitor Annually*

These are items which display minor isolated damage; however, do not pose an immediate risk to workers from exposure to asbestos fibres due to the current condition of the material and/or location. No remediation is required at this time; however, these items should be monitored on a yearly basis for evidence of continued degradation. Should the condition of the material change, an evaluation should be completed by a competent person to determine remedial action.

##### *Abatement Action Required*

These are items which display damage and may pose potential risk to workers from exposure to asbestos fibres due to the physical condition and/or location of the material. Clean-up, repair or removal of these materials is required as soon as reasonably possible.

### 4.0 Findings

Inspections of the building were conducted by MTE on July 5-6, 2021, March 29, 2022 and September 28, 2022. The two-storey school was constructed in 1955 with additions in 1958, 1962, 1966, 1971, 1972, 2000, 2001, and 2011. The inspection did not include areas of post 1990 construction or renovation (where all building finishes have been removed and replaced), as applicable.

The Asbestos Management Database is provided in **Appendix A** and associated Figures are provided in **Appendix B**. These together provide a current summary of the ACM identified throughout the building.



A summary of the damaged ACM identified at the time of the inspection is provided in **Appendix C**.

The bulk asbestos sample location and analytical summary is provided in **Appendix C**.

#### 4.1 Analytical Results

During this inspection, no samples were collected.

#### 4.2 Removed ACM

A summary of ACM that has been removed since the previous audit/inspection is provided below:

WRDSB Room 124.

- All vinyl floor tile 9"x 9" – grey with white streak and associated mastic.

WRDSB Room 104, 122, 128.

- All vinyl floor tile 9"x 9" – olive with white fleck and associated mastic.

WRDSB Room 103B, 103D, 101 and 126.

- All vinyl floor tile 9"x 9" – grey with white, black, red fleck and associated mastic.

WRDSB Room 404, 404A, 404B, 404C, 404D, 404E and 404F.

- All vinyl floor tile 9"x 9" – tan with white and black fleck and associated mastic.

WRDSB Room 822.

- All vinyl floor tile 9"x 9" – grey with white and grey streak and associated mastic.

WRDSB Room 103E.

- All vinyl sheet flooring and associated mastic.

WRDSB Room 101, 102, 102C, 103A, 103B, 103C, 103D, 103E, 103F, 104, 104C, 118, 118A, 120, 120A, 121, 122, 123, 124, 125, 126, 127, 128, 821, 901 and 902.

- All spray-applied fire proofing on structural steel;
- All pipe fittings; and
- All drywall ceilings.

WRDSB Room 101, 102, 102A, 102B, 102C, 103A, 103B, 103C, 103D, 103E, 103F, 104, 104C, 121, 123, 125, 127, 809, 901 and 902.

- All ceiling tiles 1'x1' – medium and small pinhole.

WRDSB Room 102A, 102B and 102C.

- All spray-applied fire proofing on structural steel.

WRDSB Room 803/809 intersection.

- 2 pipe fittings.

WRDSB Room 511.

- All pipe fittings and pipe straights.

### 4.3 Discovery of Additional ACM

ACM that was not previously identified includes the following:

Friable Material:

- WRDSB Room 120A – trowel-applied fireproofing.

### 4.4 Damaged ACM

Damaged ACM was identified. Refer to **Appendix C, Tables 1 and 2** for a detailed summary of required actions, specific to each material. At the time of the audit, all other ACM at the building was noted to be in good condition.

## 5.0 Recommendations

### 5.1 Remedial

Damaged ACM was identified. Refer to Appendix C, Tables 1 and 2 for a detailed summary of required actions, specific to each material. At the time of the audit, all other ACM at the building was noted to be in good condition.

Type 1 abatement Operations may be conducted internally by trained and qualified WRDSB staff. All other abatement work must be conducted by certified asbestos contractors trained and qualified to conduct the type of work required.

All asbestos work must be conducted by staff and/or contractors who are trained and experienced in the type of asbestos operations required, and should be overseen by a qualified third party Health, Safety and Environmental professional. In order to conduct Type 3 asbestos operations, contractors must be certified as Asbestos Abatement Workers AAW (Trade code 253W) and Asbestos Abatement Supervisors AAS (Trade code 253S) by The Ministry of Training, Colleges and Universities (Ministry of Advanced Education and Skills Development) as prescribed by Section 20 of O. Reg. 278/05.

### 5.2 Long Term Management

This audit was conducted for the long term management of ACM within the building. Prior to future construction or renovation projects, additional assessments and/or sampling may be required.

There are no requirements under current legislation to remove ACM from a building simply because it is present. However, O. Reg. 278/05 requires that an Asbestos Management Plan be implemented and maintained. Asbestos awareness training should be provided for staff that may come in contact with ACM during routine duties or in emergency situations.

ACM that will be disturbed, or will likely be disturbed, during building maintenance, renovations, construction, or demolition activities must be handled and disposed of in accordance with the procedures prescribed by O. Reg. 278/05.

ACM may also be present in concealed locations. If any construction, renovation, alteration, or maintenance activities are required or planned, invasive inspections of concealed locations for potential ACM must be performed prior to such activities. Should any suspect ACM be discovered, work should cease and the materials should not be disturbed. Suspect ACM must be treated as asbestos-containing or sampled and proven to not contain asbestos. Any activities that require disturbance of ACM must be performed in accordance with O. Reg. 278/05.

## 6.0 Limitations

Services performed by **MTE Consultants Inc.** (MTE) were conducted in a manner consistent with the level of care and skill ordinarily exercised by members of the Environmental Engineering & Consulting profession. No other representation expressed or implied as to the accuracy of the information, conclusions or recommendations is included or intended in this report.

This report was completed for the sole use of MTE and the Client. It was completed in accordance with the approved Scope of Work referred to in Section 0. As such, this report may not deal with all issues potentially applicable to the site and may omit issues that are or may be of interest to the reader. MTE makes no representation that the present report has dealt with all-important environmental features, except as provided in the Scope of Work. All findings and conclusions presented in this report are based on site conditions, as they existed during the time period of the investigation. This report is not intended to be exhaustive in scope or to imply a risk-free facility.

Any use which a third party makes of this report, or any reliance on, or decisions to be made based upon it, are the responsibility of such third parties. MTE accepts no responsibility for liabilities incurred by or damages, if any, suffered by any third party as a result of decisions made or actions taken, based upon this report. Others with interest in the site should undertake their own investigations and studies to determine how or if the condition affects them or their plans.

It should be recognized that the passage of time might affect the views, conclusions and recommendations (if any) provided in this report because environmental conditions of a property can change. Should additional or new information become available, MTE recommends that it be brought to our attention in order that we may re-assess the contents of this report.

All of which is respectfully submitted,

**MTE Consultants Inc.**

**Michael Bennett, B.E.S.**  
Indoor Environments Technologist  
519-743-6500 ext. 1459  
[mbennett@mte85.com](mailto:mbennett@mte85.com)

**Paul Semeniuk, B.E.S., C.E.T.**  
Manager, Indoor Environments  
519-743-6500 ext. 1324  
[psemeniuk@mte85.com](mailto:psemeniuk@mte85.com)

PXS:smk  
Attach.

M:\34532\921\1 - Reports\Waterloo Oxford District S.S\Report 2021\2022 Report Revision\34532-921\_2022-10-25\_Rpt - Asbestos Audit - Waterloo Oxford District Secondary School.docx

# Appendix A

---

## **Asbestos Management Database**





<b>School Name</b> <b>Waterloo-Oxford District Secondary School</b> <b>Date Built:</b> Original: 1955 Addition(s): 1958, 1962, 1966, 1971, 1972, 2000, 2001, 2011	<b>Legend:</b> <b>HM</b> - Homogenous Material - homogeneous with previously sampled material <b>SL</b> - Sample Location - Material Sampled <b>VC</b> - Visually Confirmed - Material not sampled, deemed ACM <b>NF</b> - Non-Friable <b>F</b> - Friable	<b>Notes:</b> All quantities provided on Figures, if known. Refer to the Asbestos Audit Update Report for condition of ACM and recommended actions. Dates provided in Material Description/Room Description columns indicates date of installation/renovation and confirms the finishes as non-ACM.
---	--	---

WRDSB Fixed Reference Number	Room Description	Inspected Item	Inspected Material	Material Description	Friability	Asbestos Classification	Sample / Identification Summary	Sample ID	Sample Date	% Asbestos & Fibre Type
<b>Structure/Additions</b>										
	Original Building	Structure	Deck	Concrete	-	Non ACM	-	-	-	-
	Original Building	Structure	Concrete	Concrete	-	Non ACM	-	-	-	-
	Original Building	Façade	Brick Veneer	Brick and Mortar	-	Non ACM	-	-	-	-
	Original Building	Not Inspected	Not Inspected	Roofing Materials	NF	Suspect ACM	VC	-	-	-
	Original Building	Windows	Interior/Exterior Frames	Silicon Sealant	-	Non ACM	-	-	-	-
	Original Building	Doors	Exterior Frames	Silicon Sealant	-	Non ACM	-	-	-	-
	Original Building	Mastic	Mastic	Floor Tile Mastic	NF	ACM	HM	32523-WOHS S68	10-Mar-08	3.5% Chrysotile
	1958 Addition	Structure	Deck	Concrete	-	Non ACM	-	-	-	-
	1958 Addition	Structure	Concrete	Concrete	-	Non ACM	-	-	-	-
	1958 Addition	Façade	Brick Veneer	Brick and Mortar	-	Non ACM	-	-	-	-
	1958 Addition	Not Inspected	Not Inspected	Roofing Materials	NF	Suspect ACM	VC	-	-	-
	1958 Addition	Windows	Interior/Exterior Frames	Silicon Sealant	-	Non ACM	-	-	-	-
	1958 Addition	Doors	Exterior Frames	Silicon Sealant	-	Non ACM	-	-	-	-
	1958 Addition	Mastic	Mastic	Floor Tile Mastic	NF	ACM	HM	32523-WOHS S28	10-Mar-08	1.9% Chrysotile
	1962 Addition	Structure	Deck	Steel	-	Non ACM	-	-	-	-
	1962 Addition	Structure	Concrete	Concrete	-	Non ACM	-	-	-	-
	1962 Addition	Façade	Brick Veneer	Brick and Mortar	-	Non ACM	-	-	-	-
	1962 Addition	Not Inspected	Not Inspected	Roofing Materials	NF	Suspect ACM	VC	-	-	-
	1962 Addition	Windows	Interior/Exterior Frames	Beige Sealant	NF	ACM	HM	S04	5-Jun-18	1% Chrysotile
	1962 Addition	Doors	Exterior Frames	Silicon Sealant	-	Non ACM	-	-	-	-
	1962 Addition	Mastic	Mastic	Floor Tile Mastic	-	Non ACM	-	32523-WOHS S15	10-Mar-08	ND
	1962 Addition	Ceiling	Ceiling Tile 1' x 1'	Brown Mastic	-	Non ACM	HM	S12	10-May-18	ND
	1966 Addition	Structure	Deck	Steel	-	Non ACM	-	-	-	-
	1966 Addition	Structure	Concrete	Concrete	-	Non ACM	-	-	-	-
	1966 Addition	Façade	Brick Veneer	Brick and Mortar	-	Non ACM	-	-	-	-
	1966 Addition	Not Inspected	Not Inspected	Roofing Materials	NF	Suspect ACM	VC	-	-	-
	1966 Addition	Windows	Interior/Exterior Frames	Beige Sealant	NF	ACM	HM	S05	5-Jun-18	5% Chrysotile
	1966 Addition	Doors	Exterior Frames	Silicon Sealant	-	Non ACM	-	-	-	-
	1966 Addition	Mastic	Mastic	Floor Tile Mastic	-	Non ACM	-	32523-WOHS S09	10-Mar-08	ND



<b>School Name</b> <b>Waterloo-Oxford District Secondary School</b> <b>Date Built:</b> Original: 1955 Addition(s): 1958, 1962, 1966, 1971, 1972, 2000, 2001, 2011	<b>Legend:</b> <b>HM</b> - Homogenous Material - homogeneous with previously sampled material <b>SL</b> - Sample Location - Material Sampled <b>VC</b> - Visually Confirmed - Material not sampled, deemed ACM <b>NF</b> - Non-Friable <b>F</b> - Friable	<b>Notes:</b> All quantities provided on Figures, if known. Refer to the Asbestos Audit Update Report for condition of ACM and recommended actions. Dates provided in Material Description/Room Description columns indicates date of installation/renovation and confirms the finishes as non-ACM.
---	--	---

WRDSB Fixed Reference Number	Room Description	Inspected Item	Inspected Material	Material Description	Friability	Asbestos Classification	Sample / Identification Summary	Sample ID	Sample Date	% Asbestos & Fibre Type
	1966 Addition	Ceiling	Ceiling Tile 1' x 1'	Brown Mastic	-	Non ACM	HM	S13	10-May-18	ND
	1971 Addition	Structure	Deck	Steel	-	Non ACM	-	-	-	-
	1971 Addition	Structure	Concrete	Concrete	-	Non ACM	-	-	-	-
	1971 Addition	Façade	Brick Veneer	Brick and Mortar	-	Non ACM	-	-	-	-
	1971 Addition	Not Inspected	Not Inspected	Roofing Materials	NF	Suspect ACM	VC	-	-	-
	1971 Addition	Windows	Interior/Exterior Frames	Silicon Sealant	-	Non ACM	-	-	-	-
	1971 Addition	Doors	Interior/Exterior Frames	Silicon Sealant	-	Non ACM	-	-	-	-
	1971 Addition	Mastic	Mastic	Floor Tile Mastic	NF	ACM	HM	32523-WOHS S32	10-Mar-08	3.3% Chrysotile
	1972 Addition	Structure	Deck	Steel	-	Non ACM	-	-	-	-
	1972 Addition	Structure	Concrete	Concrete	-	Non ACM	-	-	-	-
	1972 Addition	Façade	Brick Veneer	Brick and Mortar	-	Non ACM	-	-	-	-
	1972 Addition	Not Inspected	Not Inspected	Roofing Materials	NF	Suspect ACM	-	-	-	-
	1972 Addition	Windows	Interior/Exterior Frames	Beige Sealant	-	Non ACM	HM	S03	5-Jun-18	8% Chrysotile
	1972 Addition	Doors	Interior Frames	Beige Sealant	-	Non ACM	HM	S02	5-Jun-18	8% Chrysotile
	1972 Addition	Doors	Exterior Frames	Brown Sealant	-	Non ACM	HM	S01	5-Jun-18	ND
	1972 Addition	Mastic	Mastic	Floor Tile Mastic	NF	ACM	HM	32523-WOHS S88	10-Mar-08	0.75% Chrysotile
<b>Level 1</b>										
101	Office	Floor	Vinyl Sheet Flooring	Grey Fleck (2021)	-	Non ACM	-	-	-	-
101	Office	Wall	Concrete	-	-	Non ACM	-	-	-	-
101	Office	Ceiling	Ceiling Tile 2' x 4'	Random Fissure Random Pinhole (2021)	-	Non ACM	-	-	-	-
101	Office	Firespray	Firespray	Colour Sprayed Applied (2021)	-	Non ACM	-	-	-	-
102	Classroom	Floor	Vinyl Floor Tile 12"x 12"	Teal Dense Fleck	-	Non ACM	SL	S07ABC	13-Mar-08	ND
102	Classroom	Wall	Wood	-	-	Non ACM	-	-	-	-
102	Classroom	Wall	Concrete	-	-	Non ACM	-	-	-	-
102	Classroom	Wall	Cork Board	-	-	Non ACM	-	-	-	-
102	Classroom	Ceiling	Ceiling Tile 2' x 4'	Random Fissure Random Pinhole (2021)	-	Non ACM	-	-	-	-
102	Classroom	Firespray	Firespray	Colour Sprayed Applied (2021)	-	Non ACM	-	-	-	-
102A	Lunchroom	Floor	Vinyl Floor Tile 12"x 12"	Teal Dense Fleck	-	Non ACM	SL	S07ABC	13-Mar-08	ND
102A	Lunchroom	Wall	Concrete	-	-	Non ACM	-	-	-	-
102A	Lunchroom	Wall	Drywall	Drywall Joint Compound	NF	ACM	HM	S07	10-Mar-08	1.8% Chrysotile

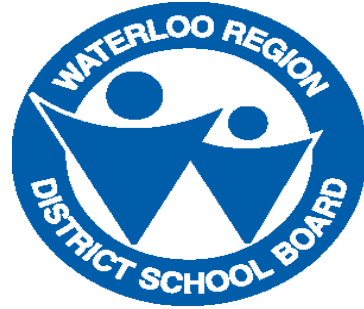

<b>School Name</b> <b>Waterloo-Oxford District Secondary School</b> <b>Date Built:</b> Original: 1955 Addition(s): 1958, 1962, 1966, 1971, 1972, 2000, 2001, 2011	<b>Legend:</b> <b>HM</b> - Homogenous Material - homogeneous with previously sampled material <b>SL</b> - Sample Location - Material Sampled <b>VC</b> - Visually Confirmed - Material not sampled, deemed ACM <b>NF</b> - Non-Friable <b>F</b> - Friable	<b>Notes:</b> All quantities provided on Figures, if known. Refer to the Asbestos Audit Update Report for condition of ACM and recommended actions. Dates provided in Material Description/Room Description columns indicates date of installation/renovation and confirms the finishes as non-ACM.
---	--	---

WRDSB Fixed Reference Number	Room Description	Inspected Item	Inspected Material	Material Description	Friability	Asbestos Classification	Sample / Identification Summary	Sample ID	Sample Date	% Asbestos & Fibre Type
102A	Lunchroom	Ceiling	Deck	Steel	-	Non ACM	-	-	-	-
102A	Lunchroom	Firespray	Firespray	Grey (2022)	-	Non ACM	-	-	-	-
102B	Head CU	Floor	Carpet	-	-	Non ACM	-	-	-	-
102B	Head CU	Wall	Concrete	-	-	Non ACM	-	-	-	-
102B	Head CU	Ceiling	Deck	Steel	-	Non ACM	-	-	-	-
102B	Head CU	Firespray	Firespray	Grey (2022)	-	Non ACM	-	-	-	-
102C	Workroom	Floor	Vinyl Floor Tile 12"x 12"	Teal Dense Fleck	-	Non ACM	SL	S07ABC	13-Mar-08	ND
102C	Workroom	Wall	Wood	-	-	Non ACM	-	-	-	-
102C	Workroom	Wall	Concrete	-	-	Non ACM	-	-	-	-
102C	Workroom	Wall	Cork Board	-	-	Non ACM	-	-	-	-
102C	Workroom	Ceiling	Deck	Steel	-	Non ACM	-	-	-	-
102C	Workroom	Firespray	Firespray	Grey (2022)	-	Non ACM	-	-	-	-
102D	Washroom	Floor	Vinyl Floor Tile 12"x 12"	Teal Dense Fleck	-	Non ACM	SL	S07ABC	13-Mar-08	ND
102D	Washroom	Wall	Wood	-	-	Non ACM	-	-	-	-
102D	Washroom	Wall	Concrete	-	-	Non ACM	-	-	-	-
102D	Washroom	Wall	Cork Board	-	-	Non ACM	-	-	-	-
102D	Washroom	Ceiling	Plaster	-	-	Non ACM	HM	S72, S82	13-Mar-08	ND
103	Classroom	Floor	Vinyl Floor Tile 9"x 9"	Grey with White	NF	ACM	HM	S18	10-Mar-08	1.8% Chrysotile
103	Classroom	Wall	Concrete	-	-	Non ACM	-	-	-	-
103	Classroom	Ceiling	Metal Pan	-	-	Non ACM	-	-	-	-
103	Classroom	Firespray	Firespray	Colour Sprayed Applied (2021)	-	Non ACM	-	-	-	-
103A	Washroom	Floor	Vinyl Sheet Flooring	Grey Fleck (2021)	-	Non ACM	-	-	-	-
103A	Washroom	Wall	Concrete	-	-	Non ACM	-	-	-	-
103A	Washroom	Wall	Drywall	Post 2010	-	Non ACM	-	-	-	-
103A	Washroom	Wall	Plaster	-	-	Non ACM	HM	S72, S82	13-Mar-08	ND
103A	Washroom	Ceiling	Ceiling Tile 2' x 4'	Random Fissure Random Pinhole (2021)	-	Non ACM	-	-	-	-
103A	Washroom	Firespray	Firespray	Colour Sprayed Applied (2021)	-	Non ACM	-	-	-	-
103B	Washroom	Floor	Vinyl Sheet Flooring	Grey Fleck (2021)	-	Non ACM	-	-	-	-
103B	Washroom	Wall	Concrete	-	-	Non ACM	-	-	-	-
103B	Washroom	Wall	Plaster	-	-	Non ACM	HM	S72, S82	13-Mar-08	ND
103B	Washroom	Ceiling	Ceiling Tile 2' x 4'	Random Fissure Random Pinhole (2021)	-	Non ACM	-	-	-	-
103B	Washroom	Firespray	Firespray	Colour Sprayed Applied (2021)	-	Non ACM	-	-	-	-

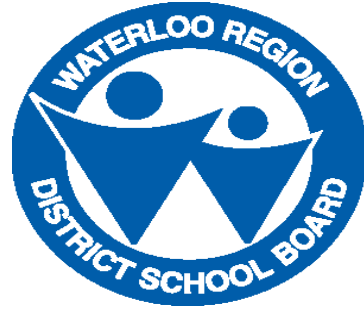

<b>School Name</b> <b>Waterloo-Oxford District Secondary School</b> <b>Date Built:</b> Original: 1955 Addition(s): 1958, 1962, 1966, 1971, 1972, 2000, 2001, 2011	<b>Legend:</b> <b>HM</b> - Homogenous Material - homogeneous with previously sampled material <b>SL</b> - Sample Location - Material Sampled <b>VC</b> - Visually Confirmed - Material not sampled, deemed ACM <b>NF</b> - Non-Friable <b>F</b> - Friable	<b>Notes:</b> All quantities provided on Figures, if known. Refer to the Asbestos Audit Update Report for condition of ACM and recommended actions. Dates provided in Material Description/Room Description columns indicates date of installation/renovation and confirms the finishes as non-ACM.
---	--	---

WRDSB Fixed Reference Number	Room Description	Inspected Item	Inspected Material	Material Description	Friability	Asbestos Classification	Sample / Identification Summary	Sample ID	Sample Date	% Asbestos & Fibre Type
103C	Workroom	Floor	Vinyl Sheet Flooring	Laminate Pattern	-	Non ACM	-	-	-	-
103C	Workroom	Wall	Concrete	-	-	Non ACM	-	-	-	-
103C	Workroom	Wall	Plaster	-	-	Non ACM	HM	S72, S82	13-Mar-08	ND
103C	Workroom	Ceiling	Ceiling Tile 2' x 4'	Random Fissure Random Pinhole (2021)	-	Non ACM	-	-	-	-
103C	Workroom	Ceiling	Ceiling Tile 2' x 4'	Short Fissure Random Pinhole	-	Non ACM	HM	S01	10-May-18	ND
103C	Workroom	Firespray	Firespray	Colour Sprayed Applied (2021)	-	Non ACM	-	-	-	-
103D	Workroom	Floor	Vinyl Sheet Flooring	Grey Fleck (2021)	-	Non ACM	-	-	-	-
103D	Workroom	Wall	Concrete	-	-	Non ACM	-	-	-	-
103D	Workroom	Wall	Plaster	-	-	Non ACM	HM	S72, S82	13-Mar-08	ND
103D	Workroom	Wall	Drywall	Drywall Joint Compound	NF	ACM	HM	S81	10-Mar-08	1% Chrysotile
103D	Workroom	Wall	Wood	-	-	Non ACM	HM	-	13-Mar-08	ND
103D	Workroom	Ceiling	Ceiling Tile 2' x 4'	Random Fissure Random Pinhole (2021)	-	Non ACM	-	-	-	-
103D	Workroom	Firespray	Firespray	Colour Sprayed Applied (2021)	-	Non ACM	-	-	-	-
103E	Washroom	Floor	Vinyl Sheet Flooring	Grey Fleck (2021)	-	Non ACM	-	-	-	-
103E	Washroom	Wall	Concrete	-	-	Non ACM	-	-	-	-
103E	Washroom	Wall	Drywall	Drywall Joint Compound	NF	ACM	HM	S07	10-Mar-08	1.8% Chrysotile
103E	Washroom	Ceiling	Plaster	-	-	Non ACM	HM	S72, S82	13-Mar-08	ND
103E	Washroom	Ceiling	Ceiling Tile 2' x 4'	Random Fissure Random Pinhole (2021)	-	Non ACM	-	-	-	-
103E	Washroom	Firespray	Firespray	Colour Sprayed Applied (2021)	-	Non ACM	-	-	-	-
104	Classroom	Floor	Vinyl Sheet Flooring	Grey Fleck (2021)	-	Non ACM	-	-	-	-
104	Classroom	Wall	Concrete	-	-	Non ACM	-	-	-	-
104	Classroom	Wall	Plaster	-	-	Non ACM	HM	S72, S82	13-Mar-08	ND
104	Classroom	Ceiling	Ceiling Tile 2' x 4'	Random Fissure Random Pinhole (2021)	-	Non ACM	-	-	-	-
104	Classroom	Firespray	Firespray	Colour Sprayed Applied (2021)	-	Non ACM	-	-	-	-
104A	Greenhouse	Floor	Concrete	-	-	Non ACM	-	-	-	-
104A	Greenhouse	Walls	Glass	-	-	Non ACM	-	-	-	-
104A	Greenhouse	Ceiling	Glass	-	-	Non ACM	-	-	-	-
104A	Greenhouse	Panels	Transite Panels at Seams	Transite	NF	ACM	VC	-	-	-
104B	Greenhouse	Floor	Concrete	-	-	Non ACM	-	-	-	-
104B	Greenhouse	Wall	Concrete	-	-	Non ACM	-	-	-	-
104B	Greenhouse	Wall	Plaster	-	-	Non ACM	HM	S72, S82	13-Mar-08	ND
104B	Greenhouse	Ceiling	Ceiling Tile 2' x 4'	Short Fissure Random Pinhole	-	Non ACM	HM	S01	10-May-18	ND





<b>School Name</b> <b>Waterloo-Oxford District Secondary School</b> <b>Date Built:</b> Original: 1955 Addition(s): 1958, 1962, 1966, 1971, 1972, 2000, 2001, 2011	<b>Legend:</b> <b>HM</b> - Homogenous Material - homogeneous with previously sampled material <b>SL</b> - Sample Location - Material Sampled <b>VC</b> - Visually Confirmed - Material not sampled, deemed ACM <b>NF</b> - Non-Friable <b>F</b> - Friable	<b>Notes:</b> All quantities provided on Figures, if known. Refer to the Asbestos Audit Update Report for condition of ACM and recommended actions. Dates provided in Material Description/Room Description columns indicates date of installation/renovation and confirms the finishes as non-ACM.
---	--	---

WRDSB Fixed Reference Number	Room Description	Inspected Item	Inspected Material	Material Description	Friability	Asbestos Classification	Sample / Identification Summary	Sample ID	Sample Date	% Asbestos & Fibre Type
104B	Greenhouse	Ceiling	Wood	-	-	Non ACM	-	-	-	-
104C	Storage	Floor	Vinyl Sheet Flooring	Grey Fleck (2021)	-	Non ACM	-	-	-	-
104C	Storage	Wall	Concrete	-	-	Non ACM	-	-	-	-
104C	Storage	Wall	Plywood	Wood	-	Non ACM	-	-	-	-
104C	Storage	Ceiling	Plaster	-	-	Non ACM	HM	S72, S82	13-Mar-08	ND
104C	Storage	Piping	Pipe Insulation	Fibreglass insulation	-	Non ACM	-	-	-	-
104C	Storage	Piping	Pipe Fitting	Parged Cement	F	ACM	HM	1680.894.03	11-Sep-90	50-75% Chrysotile
104C	Storage	Firespray	Firespray	Colour Sprayed Applied (2021)	-	Non ACM	-	-	-	-
200A	Library	Floor	Vinyl Floor Tile 12"x 12"	Teal Dense Fleck	-	Non ACM	HM	S07ABC	13-Mar-08	ND
200A	Library	Wall	Drywall	Drywall Joint Compound	NF	ACM	HM	S81	10-Mar-08	1% Chrysotile
200A	Library	Ceiling	Ceiling Tile 2' x 4'	Short Fissure Random Pinhole (2001)	-	Non ACM	-	-	-	-
200B	Library	Floor	Vinyl Floor Tile 12"x 12"	Teal Dense Fleck	-	Non ACM	HM	S07ABC	13-Mar-08	ND
200B	Library	Wall	Concrete	-	-	Non ACM	-	-	-	-
200B	Library	Wall	Drywall	Drywall Joint Compound	NF	ACM	HM	S81	10-Mar-08	1% Chrysotile
200B	Library	Ceiling	Ceiling Tile 2' x 4'	Short Fissure Random Pinhole (2001)	-	Non ACM	-	-	-	-
200E	Library	Floor	Vinyl Floor Tile 12"x 12"	Teal Dense Fleck	-	Non ACM	HM	S07ABC	13-Mar-08	ND
200E	Library	Floor	Carpet	-	-	Non ACM	-	-	-	-
200E	Library	Wall	Drywall	Drywall Joint Compound	NF	ACM	HM	S81	10-Mar-08	1% Chrysotile
200E	Library	Wall	Plaster	-	-	Non ACM	HM	S82	13-Mar-08	ND
200E	Library	Ceiling	Ceiling Tile 2' x 4'	Short Fissure Random Pinhole (2001)	-	Non ACM	-	-	-	-
200F	Library	Floor	Vinyl Floor Tile 12"x 12"	Teal Dense Fleck	-	Non ACM	HM	S07ABC	13-Mar-08	ND
200F	Library	Wall	Concrete	-	-	Non ACM	-	-	-	-
200F	Library	Wall	Drywall	Drywall Joint Compound	NF	ACM	HM	S81	10-Mar-08	1% Chrysotile
200F	Library	Wall	Plaster	-	-	Non ACM	HM	S64, S82	10-Mar-08	ND
200F	Library	Ceiling	Ceiling Tile 2' x 4'	Short Fissure Random Pinhole (2001)	-	Non ACM	-	-	-	-
201	Office	Floor	Vinyl Floor Tile 9"x 9"	Grey with Black	NF	ACM	SL	S89	13-Mar-08	2.4% Chrysotile
201	Office	Wall	Plaster	-	-	Non ACM	HM	S64, S82	10-Mar-08	ND
201	Office	Ceiling	Ceiling Tile 2' x 4'	Short Fissure Random Pinhole	-	Non ACM	HM	S01	10-May-18	ND
201A	Health	Floor	Vinyl Floor Tile 12"x 12"	Grey with Spots	-	Non ACM	SL	S91	10-May-18	ND
201A	Health	Floor	Vinyl Floor Tile 12"x 12"	Teal Dense Fleck	-	Non ACM	SL	S07ABC	13-Mar-08	ND
201A	Health	Wall	Concrete	-	-	Non ACM	-	-	-	-
201A	Health	Wall	Plaster	-	-	Non ACM	HM	S64, S82	10-Mar-08	ND



<b>School Name</b> <b>Waterloo-Oxford District Secondary School</b> <b>Date Built:</b> Original: 1955 Addition(s): 1958, 1962, 1966, 1971, 1972, 2000, 2001, 2011	<b>Legend:</b> <b>HM</b> - Homogenous Material - homogeneous with previously sampled material <b>SL</b> - Sample Location - Material Sampled <b>VC</b> - Visually Confirmed - Material not sampled, deemed ACM <b>NF</b> - Non-Friable <b>F</b> - Friable	<b>Notes:</b> All quantities provided on Figures, if known. Refer to the Asbestos Audit Update Report for condition of ACM and recommended actions. Dates provided in Material Description/Room Description columns indicates date of installation/renovation and confirms the finishes as non-ACM.
---	--	---

WRDSB Fixed Reference Number	Room Description	Inspected Item	Inspected Material	Material Description	Friability	Asbestos Classification	Sample / Identification Summary	Sample ID	Sample Date	% Asbestos & Fibre Type
201A	Health	Wall	Drywall	Drywall Joint Compound	NF	ACM	HM	S81	10-Mar-08	1% Chrysotile
201A	Health	Ceiling	Ceiling Tile 2' x 4'	Short Fissure Random Pinhole	-	Non ACM	HM	S01	10-May-18	ND
201B	Shower	Floor	Ceramic Tile	-	-	Non ACM	-	-	-	-
201B	Shower	Wall	Ceramic Tile	-	-	Non ACM	-	-	-	-
201B	Shower	Ceiling	Ceiling Tile 2' x 4'	Short Fissure Random Pinhole (Post 2010)	-	Non ACM	-	-	-	-
202	Classroom	Floor	Vinyl Floor Tile 12"x 12"	Taupe	NF	ACM	SL	S84abc	13-Mar-08	2.2% Chrysotile
202	Classroom	Wall	Drywall	Drywall Joint Compound	NF	ACM	HM	S81	10-Mar-08	1% Chrysotile
202	Classroom	Wall	Plaster	-	-	Non ACM	HM	S24, S72, S82	13-Mar-08	ND
202	Classroom	Ceiling	Ceiling Tile 2' x 4'	Short Fissure Random Pinhole (2004)	-	Non ACM	-	-	-	-
202	Classroom	Ceiling	Ceiling Tile 1' x 1'	Wide Fissure Random Pinhole	-	Non ACM	SL	S83abc	13-Mar-08	NA
202A	Work Room	Floor	Vinyl Floor Tile 12"x 12"	Green	-	Non ACM	SL	S80b	13-Mar-08	ND
202A	Work Room	Wall	Drywall	Drywall Joint Compound	NF	ACM	HM	S81	10-Mar-08	1% Chrysotile
202A	Work Room	Ceiling	Ceiling Tile 2' x 4'	Long Fissure Random Pinhole	-	Non ACM	SL	S85abc	13-Mar-08	ND
202A	Work Room	Ducting	Flex Joint	-	NF	ACM	VC	-	-	-
202A	Work Room	Ceiling	Ceiling Tile 1' x 1'	Wide Fissure Random Pinhole	-	Non ACM	HM	S08	10-May-18	ND
202B	Office	Floor	Vinyl Floor Tile 12"x 12"	Taupe	NF	ACM	SL	S84b	13-Mar-08	2.2% Chrysotile
202B	Office	Wall	Plaster	-	-	Non ACM	HM	S82	13-Mar-08	ND
202B	Office	Ceiling	Ceiling Tile 2' x 4'	Random Fissure, Random Pinhole	-	Non ACM	SL	S86abc	13-Mar-08	ND
203	Classroom	Floor	Vinyl Floor Tile 12"x 12"	Green	-	Non ACM	HM	S80	13-Mar-08	ND
203	Classroom	Wall	Plaster	-	-	Non ACM	SL	S82ce	13-Mar-08	ND
203	Classroom	Ceiling	Ceiling Tile 2' x 4'	Short Fissure Random Pinhole (2004)	-	Non ACM	-	-	-	-
203	Classroom	Ceiling	Ceiling Tile 1' x 1'	Large and Small Pinhole	-	Non ACM	HM	S77	13-Mar-08	NA
204	Classroom	Floor	Vinyl Floor Tile 12"x 12"	Taupe	NF	ACM	HM	S84	13-Mar-08	2.2% Chrysotile
204	Classroom	Wall	Drywall	Drywall Joint Compound	NF	ACM	HM	S81	10-Mar-08	1% Chrysotile
204	Classroom	Wall	Plaster	-	-	Non ACM	SL	S82b	13-Mar-08	ND
204	Classroom	Ceiling	Ceiling Tile 2' x 4'	Short Fissure Random Pinhole	-	Non ACM	HM	S01	10-May-18	ND
204	Classroom	Ceiling	Ceiling Tile 1' x 1'	Wide Fissure Random Pinhole	-	Non ACM	HM	S08	10-May-18	ND
205	Kitchen	Floor	Vinyl Floor Tile 12"x 12"	Green	-	Non ACM	HM	S80	13-Mar-08	ND
205	Kitchen	Wall	Drywall	Drywall Joint Compound	NF	ACM	HM	S81	10-Mar-08	1% Chrysotile
205	Kitchen	Wall	Plaster	-	-	Non ACM	SL	S82ce	13-Mar-08	ND
205	Kitchen	Ceiling	Ceiling Tile 2' x 4'	Short Fissure Random Pinhole (2004)	-	Non ACM	-	-	-	-
206	Work Room	Floor	Vinyl Floor Tile 12"x 12"	Green	-	Non ACM	SL	S80b	13-Mar-08	ND



<b>School Name</b> <b>Waterloo-Oxford District Secondary School</b> <b>Date Built:</b> Original: 1955 Addition(s): 1958, 1962, 1966, 1971, 1972, 2000, 2001, 2011	<b>Legend:</b> <b>HM</b> - Homogenous Material - homogeneous with previously sampled material <b>SL</b> - Sample Location - Material Sampled <b>VC</b> - Visually Confirmed - Material not sampled, deemed ACM <b>NF</b> - Non-Friable <b>F</b> - Friable	<b>Notes:</b> All quantities provided on Figures, if known. Refer to the Asbestos Audit Update Report for condition of ACM and recommended actions. Dates provided in Material Description/Room Description columns indicates date of installation/renovation and confirms the finishes as non-ACM.
---	--	---

WRDSB Fixed Reference Number	Room Description	Inspected Item	Inspected Material	Material Description	Friability	Asbestos Classification	Sample / Identification Summary	Sample ID	Sample Date	% Asbestos & Fibre Type
206	Work Room	Wall	Plaster	-	-	Non ACM	HM	S82	13-Mar-08	ND
206	Work Room	Ceiling	Ceiling Tile 2' x 4'	Short Fissure Random Pinhole	-	Non ACM	HM	S01	10-May-18	ND
206	Work Room	Ceiling	Ceiling Tile 1' x 1'	Large and Small Pinhole	-	Non ACM	SL	S77b	13-Mar-08	ND
206A	Work Room	Floor	Vinyl Floor Tile 12"x 12"	Green	-	Non ACM	SL	S80b	13-Mar-08	ND
206A	Work Room	Wall	Plaster	-	-	Non ACM	HM	S82	13-Mar-08	ND
206A	Work Room	Ceiling	Ceiling Tile 2' x 4'	Short Fissure Random Pinhole	-	Non ACM	HM	S01	10-May-18	ND
206A	Work Room	Ceiling	Ceiling Tile 1' x 1'	Large and Small Pinhole	-	Non ACM	SL	S77b	13-Mar-08	ND
207	Classroom	Floor	Vinyl Floor Tile 12"x 12"	Grey/Green	NF	ACM	SL	S88abc	13-Mar-08	2.7% Chrysotile
207	Classroom	Wall	Drywall	Drywall Joint Compound	NF	ACM	HM	S81	10-Mar-08	1% Chrysotile
207	Classroom	Wall	Plaster	-	-	Non ACM	SL	S82ce	13-Mar-08	ND
207	Classroom	Ceiling	Ceiling Tile 2' x 4'	Short Fissure Random Pinhole (2004)	-	Non ACM	-	-	-	-
207	Classroom	Above Ceiling	Ceiling Tile 1' x 1'	Craters with Dots	-	Non ACM	SL	S87abc	13-Mar-08	ND
207	Classroom	Piping	Pipe Insulation	Fibreglass insulation	-	Non ACM	-	-	-	-
207A	Office	Floor	Carpet	-	-	Non ACM	-	-	-	-
207A	Office	Wall	Plaster	-	-	Non ACM	HM	S82	13-Mar-08	ND
207A	Office	Ceiling	Ceiling Tile 1' x 1'	Wide Fissure Random Pinhole	-	Non ACM	SL	S08ABC	10-May-18	ND
207C	Classroom	Floor	Vinyl Floor Tile 12"x 12"	Grey/Green	NF	ACM	SL	S88abc	13-Mar-08	2.7% Chrysotile
207C	Classroom	Wall	Drywall	Drywall Joint Compound	NF	ACM	HM	S81	10-Mar-08	1% Chrysotile
207C	Classroom	Wall	Plaster	-	-	Non ACM	SL	S82ce	13-Mar-08	ND
207C	Classroom	Ceiling	Ceiling Tile 2' x 4'	Short Fissure Random Pinhole (2004)	-	Non ACM	-	-	-	-
207C	Classroom	Above Ceiling	Ceiling Tile 1' x 1'	Craters with Dots	-	Non ACM	SL	S87abc	13-Mar-08	ND
207C	Classroom	Piping	Pipe Insulation	Fibreglass insulation	-	Non ACM	-	-	-	-
208	Classroom	Floor	Vinyl Floor Tile 12"x 12"	Green	-	Non ACM	HM	S80	13-Mar-08	ND
208	Classroom	Wall	Drywall	Drywall Joint Compound	NF	ACM	HM	S81	10-Mar-08	1% Chrysotile
208	Classroom	Ceiling	Ceiling Tile 2' x 4'	Short Fissure Random Pinhole	-	Non ACM	HM	S01	10-May-18	ND
208	Classroom	Ceiling	Ceiling Tile 1' x 1'	Large and Small Pinhole	-	Non ACM	HM	S77	13-Mar-08	NA
208	Classroom	Piping	Pipe Insulation	Fibreglass insulation	-	Non ACM	-	-	-	-
210	Office	Floor	Vinyl Floor Tile 12"x 12"	Grey Oatmeal	-	Non ACM	HM	S90	13-Mar-08	ND
210	Office	Wall	Plaster	-	-	Non ACM	HM	S64, S82	10-Mar-08	ND
210	Office	Wall	Drywall	Drywall Joint Compound	NF	ACM	HM	S81	10-Mar-08	1% Chrysotile
210	Office	Ceiling	Ceiling Tile 2' x 4'	Short Fissure Random Pinhole (1997)	-	Non ACM	-	-	-	-
210	Office	Piping	Pipe Insulation	Fibreglass insulation	-	Non ACM	-	-	-	-



<b>School Name</b> <b>Waterloo-Oxford District Secondary School</b> <b>Date Built:</b> Original: 1955 Addition(s): 1958, 1962, 1966, 1971, 1972, 2000, 2001, 2011	<b>Legend:</b> <b>HM</b> - Homogenous Material - homogeneous with previously sampled material <b>SL</b> - Sample Location - Material Sampled <b>VC</b> - Visually Confirmed - Material not sampled, deemed ACM <b>NF</b> - Non-Friable <b>F</b> - Friable	<b>Notes:</b> All quantities provided on Figures, if known. Refer to the Asbestos Audit Update Report for condition of ACM and recommended actions. Dates provided in Material Description/Room Description columns indicates date of installation/renovation and confirms the finishes as non-ACM.
---	--	---

WRDSB Fixed Reference Number	Room Description	Inspected Item	Inspected Material	Material Description	Friability	Asbestos Classification	Sample / Identification Summary	Sample ID	Sample Date	% Asbestos & Fibre Type
210A	Office	Floor	Carpet	-	-	Non ACM	-	-	-	-
210A	Office	Wall	Drywall	Drywall Joint Compound	NF	ACM	HM	S81	10-Mar-08	1% Chrysotile
210A	Office	Wall	Plaster	-	-	Non ACM	HM	S64, S82	10-Mar-08	ND
210A	Office	Ceiling	Ceiling Tile 2' x 4'	Short Fissure Random Pinhole (2004)	-	Non ACM	-	-	-	-
210B	Office	Floor	Carpet	-	-	Non ACM	-	-	-	-
210B	Office	Wall	Drywall	Drywall Joint Compound	NF	ACM	HM	S81	10-Mar-08	1% Chrysotile
210B	Office	Wall	Plaster	-	-	Non ACM	HM	S64, S82	10-Mar-08	ND
210B	Office	Ceiling	Ceiling Tile 2' x 4'	Short Fissure Random Pinhole (2004)	-	Non ACM	-	-	-	-
210C	Office	Floor	Carpet	-	-	Non ACM	-	-	-	-
210C	Office	Wall	Drywall	Drywall Joint Compound	NF	ACM	HM	S81	10-Mar-08	1% Chrysotile
210C	Office	Wall	Plaster	-	-	Non ACM	HM	S64, S82	10-Mar-08	ND
210C	Office	Ceiling	Ceiling Tile 2' x 4'	Short Fissure Random Pinhole (2004)	-	Non ACM	-	-	-	-
210D	Office	Floor	Vinyl Floor Tile 12"x 12"	Orange with White Fleck	NF	ACM	HM	S30	13-Mar-08	5.0% Chrysotile
210D	Office	Wall	Plaster	-	-	Non ACM	HM	S64, S82	10-Mar-08	ND
210D	Office	Ceiling	Ceiling Tile 1' x 1'	Large and Small Pinhole	-	Non ACM	HM	S77	13-Mar-08	ND
210E	Office	Floor	Vinyl Floor Tile 12"x 12"	Orange with White Fleck	NF	ACM	HM	S30	13-Mar-08	5.0% Chrysotile
210E	Office	Wall	Plaster	-	-	Non ACM	HM	S64, S82	10-Mar-08	ND
210E	Office	Ceiling	Ceiling Tile 1' x 1'	Large and Small Pinhole	-	Non ACM	HM	S77	13-Mar-08	ND
210F	Office	Floor	Vinyl Floor Tile 9"x 9"	Green with Faded Streak	NF	ACM	SL	S76abc	13-Mar-08	1.4% Chrysotile
210F	Office	Wall	Concrete	-	-	Non ACM	-	-	-	-
210F	Office	Ceiling	Plaster	-	-	Non ACM	HM	S64, S82	10-Mar-08	ND
210G	Office	Floor	Carpet	-	-	Non ACM	-	-	-	-
210G	Office	Wall	Wood Panel	-	-	Non ACM	-	-	-	-
210G	Office	Wall	Plaster	-	-	Non ACM	HM	S64, S82	10-Mar-08	ND
210G	Office	Ceiling	Ceiling Tile 2' x 4'	Short Fissure Random Pinhole (2004)	-	Non ACM	-	-	-	-
2101H	Office	Floor	Vinyl Floor Tile 9"x 9"	Taupe with Spots	NF	ACM	HM	S96abc	13-Mar-08	1.5% Chrysotile
2101H	Office	Wall	Plaster	-	-	Non ACM	HM	S64, S82	10-Mar-08	ND
2101H	Office	Ceiling	Plaster	-	-	Non ACM	HM	S64, S82	10-Mar-08	ND
210I	Office	Floor	Carpet	-	-	Non ACM	-	-	-	-
210I	Office	Wall	Plaster	-	-	Non ACM	HM	S64, S82	10-Mar-08	ND
210I	Office	Ceiling	Plaster	-	-	Non ACM	HM	S64, S82	10-Mar-08	ND
300	Mechanical	Floor	Concrete	-	-	Non ACM	-	-	-	-



<b>School Name</b> <b>Waterloo-Oxford District Secondary School</b> <b>Date Built:</b> Original: 1955 Addition(s): 1958, 1962, 1966, 1971, 1972, 2000, 2001, 2011	<b>Legend:</b> <b>HM</b> - Homogenous Material - homogeneous with previously sampled material <b>SL</b> - Sample Location - Material Sampled <b>VC</b> - Visually Confirmed - Material not sampled, deemed ACM <b>NF</b> - Non-Friable <b>F</b> - Friable	<b>Notes:</b> All quantities provided on Figures, if known. Refer to the Asbestos Audit Update Report for condition of ACM and recommended actions. Dates provided in Material Description/Room Description columns indicates date of installation/renovation and confirms the finishes as non-ACM.
---	--	---

WRDSB Fixed Reference Number	Room Description	Inspected Item	Inspected Material	Material Description	Friability	Asbestos Classification	Sample / Identification Summary	Sample ID	Sample Date	% Asbestos & Fibre Type
300	Mechanical	Wall	Concrete	-	-	Non ACM	-	-	-	-
300	Mechanical	Deck	Concrete	-	-	Non ACM	-	-	-	-
300	Mechanical	Piping	Pipe Insulation	Air Cell	F	ACM	HM	1680.894.04	11-Sep-90	>75% Amosite
300	Mechanical	Mechanical	Mechanical Insulation	Boiler Breaching	F	ACM	SL	1680.894.05	11-Sep-90	50-75% Chrysotile; 25-50% Amosite
300	Mechanical	Piping	Pipe Fitting	Parged Cement	F	ACM	HM	1680.894.03	11-Sep-90	50-75% Chrysotile
300	Mechanical	Piping	Pipe Insulation	Fibreglass insulation	-	Non ACM	-	-	-	-
300A	Mechanical	Floor	Concrete	-	-	Non ACM	-	-	-	-
300A	Mechanical	Wall	Concrete	-	-	Non ACM	-	-	-	-
300A	Mechanical	Piping	Pipe Insulation	Fibreglass insulation	-	Non ACM	-	-	-	-
300A	Mechanical	Deck	Concrete	-	-	Non ACM	-	-	-	-
300A	Mechanical	Ducting	Flex Joint	-	NF	ACM	VC	-	-	-
300A	Mechanical	Piping	Pipe Fitting	Parged Cement	F	ACM	HM	1680.894.03	11-Sep-90	50-75% Chrysotile
301	Office	Floor	Hardwood	-	-	Non ACM	-	-	-	-
301	Office	Wall	Plaster	-	-	Non ACM	HM	S64, S82	10-Mar-08	ND
301	Office	Ceiling	Ceiling Tile 2' x 4'	Short Fissure Random Pinhole (1997)	-	Non ACM	VC	-	-	-
301	Office	Ceiling	Ceiling Tile 1' x 1'	Large and Small Pinhole	-	Non ACM	HM	S77	13-Mar-08	ND
301C	Office	Floor	Hardwood	-	-	Non ACM	-	-	-	-
301C	Office	Wall	Plaster	-	-	Non ACM	HM	S64, S82	10-Mar-08	ND
301C	Office	Ceiling	Ceiling Tile 2' x 4'	Short Fissure Random Pinhole (1997)	-	Non ACM	VC	-	-	-
301C	Office	Ceiling	Ceiling Tile 1' x 1'	Large and Small Pinhole	-	Non ACM	HM	S77	13-Mar-08	ND
301D	Office	Floor	Hardwood	-	-	Non ACM	-	-	-	-
301D	Office	Wall	Plaster	-	-	Non ACM	HM	S64, S82	10-Mar-08	ND
301D	Office	Ceiling	Ceiling Tile 2' x 4'	Short Fissure Random Pinhole (1997)	-	Non ACM	VC	-	-	-
301D	Office	Ceiling	Ceiling Tile 1' x 1'	Large and Small Pinhole	-	Non ACM	HM	S77	13-Mar-08	ND
301E	Office	Floor	Hardwood	-	-	Non ACM	-	-	-	-
301E	Office	Wall	Plaster	-	-	Non ACM	HM	S64, S82	10-Mar-08	ND
301E	Office	Ceiling	Ceiling Tile 2' x 4'	Short Fissure Random Pinhole (1997)	-	Non ACM	VC	-	-	-
301E	Office	Ceiling	Ceiling Tile 1' x 1'	Large and Small Pinhole	-	Non ACM	HM	S77	13-Mar-08	ND
302	Work Room	Floor	Vinyl Floor Tile 12"x 12"	Cream with Brown	NF	ACM	SL	S94abc	13-Mar-08	1.2% Chrysotile
302	Work Room	Wall	Plaster	-	-	Non ACM	SL	S82g	13-Mar-08	ND
302	Work Room	Ceiling	Ceiling Tile 2' x 2'	Random Fissure	-	Non ACM	SL	S93abc	13-Mar-08	ND
302	Work Room	Piping	Pipe Insulation	Fibreglass insulation	-	Non ACM	-	-	-	-



<b>School Name</b> <b>Waterloo-Oxford District Secondary School</b> <b>Date Built:</b> Original: 1955 Addition(s): 1958, 1962, 1966, 1971, 1972, 2000, 2001, 2011	<b>Legend:</b> HM - Homogenous Material - homogeneous with previously sampled material SL - Sample Location - Material Sampled VC - Visually Confirmed - Material not sampled, deemed ACM NF - Non-Friable F- Friable	<b>Notes:</b> All quantities provided on Figures, if known. Refer to the Asbestos Audit Update Report for condition of ACM and recommended actions. Dates provided in Material Description/Room Description columns indicates date of installation/renovation and confirms the finishes as non-ACM.
---	--	---

WRDSB Fixed Reference Number	Room Description	Inspected Item	Inspected Material	Material Description	Friability	Asbestos Classification	Sample / Identification Summary	Sample ID	Sample Date	% Asbestos & Fibre Type
304	Office	Floor	Vinyl Floor Tile 12"x 12"	Brown Oatmeal	NF	ACM	SL	S95abc	13-Mar-08	0.75% Chrysotile
304	Office	Wall	Plaster	-	-	Non ACM	HM	S24, S72, S82	13-Mar-08	ND
304	Office	Ceiling	Ceiling Tile 2' x 2'	Short Fissure Random Pinhole (2001)	-	Non ACM	VC	-	-	-
304	Office	Ducting	Duct Insulation	Fibreglass insulation	-	Non ACM	-	-	-	-
304	Office	Piping	Pipe Insulation	Fibreglass insulation	-	Non ACM	-	-	-	-
305	Classroom	Floor	Vinyl Floor Tile 12"x 12"	Teal Dense Fleck	-	Non ACM	SL	S07ABC	13-Mar-08	ND
305	Classroom	Wall	Plaster	-	-	Non ACM	HM	S82	13-Mar-08	ND
305	Classroom	Ceiling	Ceiling Tile 1' x 1'	Thick Fissure Pinhole	-	Non ACM	HM	S45	13-Mar-08	ND
305A	Office	Floor	Vinyl Sheet Flooring	Grey Dense Fleck (Post 2018)	-	Non ACM	-	-	-	-
305A	Office	Wall	Plaster	-	-	Non ACM	HM	S82	13-Mar-08	ND
305A	Office	Wall	Drywall	Drywall Joint Compound	NF	ACM	HM	S07	10-Mar-08	1.8% Chrysotile
305A	Office	Ceiling	Drywall	Drywall Joint Compound	NF	ACM	HM	S07	10-Mar-08	1.8% Chrysotile
305A	Office									
305A	Office	Ceiling	Ceiling Tile 2' x 4'	Short Fissure Random Pinhole	-	Non ACM	-	-	-	-
305B	Storage	Floor	Vinyl Floor Tile 12"x 12"	Orange with White Fleck	NF	ACM	HM	S30	13-Mar-08	5.0% Chrysotile
305B	Storage	Wall	Plaster	-	-	Non ACM	HM	S82	13-Mar-08	ND
305B	Storage	Ceiling	Ceiling Tile 1' x 1'	Thick Fissure Pinhole	-	Non ACM	HM	S45	13-Mar-08	ND
305D	Washroom	Floor	Vinyl Sheet Flooring	Grey Dense Fleck (Post 2018)	-	Non ACM	-	-	-	-
305D	Washroom	Wall	Plaster	-	-	Non ACM	HM	S82	13-Mar-08	ND
305D	Washroom	Wall	Drywall	Drywall Joint Compound	NF	ACM	HM	S07	10-Mar-08	1.8% Chrysotile
305D	Washroom	Ceiling	Drywall	Drywall Joint Compound	NF	ACM	HM	S07	10-Mar-08	1.8% Chrysotile
305E	Kitchen	Floor	Vinyl Sheet Flooring	Grey Dense Fleck (Post 2018)	-	Non ACM	-	-	-	-
305E	Kitchen	Wall	Plaster	-	-	Non ACM	HM	S82	13-Mar-08	ND
305E	Kitchen	Wall	Drywall	Drywall Joint Compound	NF	ACM	HM	S07	10-Mar-08	1.8% Chrysotile
305E	Kitchen	Ceiling	Drywall	Drywall Joint Compound	NF	ACM	HM	S07	10-Mar-08	1.8% Chrysotile
305E	Kitchen	Ceiling	Ceiling Tile 2' x 2'	Thick Fissure Pinhole	-	Non ACM	HM	S06	10-May-18	ND
305F	Classroom	Floor	Vinyl Floor Tile 12"x 12"	Teal Dense Fleck	-	Non ACM	SL	S07ABC	13-Mar-08	ND
305F	Classroom	Wall	Drywall	Drywall Joint Compound	NF	ACM	HM	S07	10-Mar-08	1.8% Chrysotile
305F	Classroom	Ceiling	Ceiling Tile 1' x 1'	Thick Fissure Pinhole	-	Non ACM	HM	S45	13-Mar-08	ND
305G	Office	Floor	Vinyl Floor Tile 12"x 12"	Brown Oatmeal	NF	ACM	HM	S95	13-Mar-08	0.75% Chrysotile
305G	Office	Wall	Plaster	-	-	Non ACM	HM	S82	13-Mar-08	ND
305G	Office	Ceiling	Ceiling Tile 1' x 1'	Craters with Dots	-	Non ACM	SL	S87ac	13-Mar-08	ND

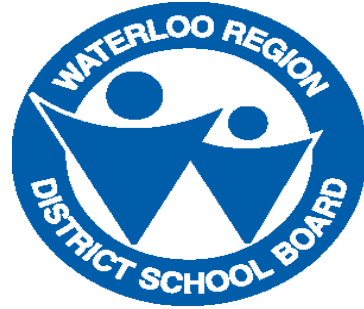

<b>School Name</b> <b>Waterloo-Oxford District Secondary School</b> <b>Date Built:</b> Original: 1955 Addition(s): 1958, 1962, 1966, 1971, 1972, 2000, 2001, 2011	<b>Legend:</b> <b>HM</b> - Homogenous Material - homogeneous with previously sampled material <b>SL</b> - Sample Location - Material Sampled <b>VC</b> - Visually Confirmed - Material not sampled, deemed ACM <b>NF</b> - Non-Friable <b>F</b> - Friable	<b>Notes:</b> All quantities provided on Figures, if known. Refer to the Asbestos Audit Update Report for condition of ACM and recommended actions. Dates provided in Material Description/Room Description columns indicates date of installation/renovation and confirms the finishes as non-ACM.
---	--	---

WRDSB Fixed Reference Number	Room Description	Inspected Item	Inspected Material	Material Description	Friability	Asbestos Classification	Sample / Identification Summary	Sample ID	Sample Date	% Asbestos & Fibre Type
306	Classroom	Floor	Vinyl Floor Tile 12"x 12"	White with Black Fleck	-	Non ACM	SL	S42abc	13-Mar-08	ND
306	Classroom	Wall	Plaster	-	-	Non ACM	HM	S24, S72, S82	13-Mar-08	ND
306	Classroom	Ceiling	Ceiling Tile 2' x 2'	Short Fissure Random Pinhole (1997)	-	Non ACM	-	-	-	-
306	Classroom	Wall	Drywall	No Drywall Joint Compound	-	Non ACM	-	-	-	-
306	Classroom	Piping	Pipe Insulation	Fibreglass insulation	-	Non ACM	-	-	-	-
307	Classroom	Floor	Vinyl Floor Tile 12"x 12"	White with Black Fleck	-	Non ACM	HM	S42	13-Mar-08	ND
307	Classroom	Wall	Plaster	-	-	Non ACM	SL	S43	13-Mar-08	ND
307	Classroom	Ceiling	Ceiling Tile 2' x 2'	Short Fissure Random Pinhole (1997)	-	Non ACM	-	-	-	-
307	Classroom	Wall	Drywall	No Drywall Joint Compound	-	Non ACM	-	-	-	-
307	Classroom	Piping	Pipe Insulation	Fibreglass insulation	-	Non ACM	-	-	-	-
308A	Office	Floor	Hardwood	-	-	Non ACM	-	-	-	-
308A	Office	Wall	Drywall	-	-	Non ACM	-	-	-	-
308A	Office	Ceiling	Ceiling Tile 2'x2'	Dense Fissure Small Pinhole	-	Non ACM	HM	S29	13-Mar-08	ND
308	Office	Floor	Vinyl Floor Tile 12"x 12"	Orange with White Fleck	NF	ACM	HM	S30	13-Mar-08	5.0% Chrysotile
308	Office	Wall	Plaster	-	-	Non ACM	HM	S24, S72, S82	13-Mar-08	ND
308	Office	Ceiling	Drywall	No Drywall Joint Compound	-	Non ACM	-	-	-	-
308	Office	Ceiling	Ceiling Tile 2' x 2'	Dense Fissure Small Pinhole	-	Non ACM	HM	S29	13-Mar-08	ND
308	Office	Piping	Pipe Insulation	Fibreglass insulation	-	Non ACM	-	-	-	-
309	Dressing Room	Floor	Vinyl Floor Tile 12"x 12"	Green with Black, White, & Grey Fleck	NF	ACM	SL	S34abc	13-Mar-08	2.2% Chrysotile
309	Dressing Room	Wall	Concrete	-	-	Non ACM	-	-	-	-
309	Dressing Room	Ceiling	Ceiling Tile 2 x 2	Large & Small Pinhole (Drywall)	-	Non ACM	-	-	-	-
309	Dressing Room	Piping	Pipe Insulation	Fibreglass insulation	-	Non ACM	-	-	-	-
309A	Washroom	Floor	Vinyl Floor Tile 12"x 12"	Green with Black, White, & Grey Fleck	NF	ACM	SL	S34abc	13-Mar-08	2.2% Chrysotile
309A	Washroom	Wall	Concrete	-	-	Non ACM	-	-	-	-
309A	Washroom	Ceiling	Plaster	-	-	Non ACM	HM	S24, S72, S82	13-Mar-08	ND
310	No Access	Not Inspected								
310A	No Access	Not Inspected								
311	Washroom	Floor	Vinyl Floor Tile 12"x 12"	Grey Dense Fleck (Post 2018)	-	Non ACM	-	-	-	-
311	Washroom	Wall	Concrete	-	-	Non ACM	-	-	-	-
311	Washroom	Ceiling	Ceiling Tile 2 x 2	Large & Small Pinhole (Drywall)	-	Non ACM	-	-	-	-
311	Washroom	Piping	Pipe Insulation	Fibreglass insulation	-	Non ACM	-	-	-	-
312	Washroom	Floor	Vinyl Floor Tile 12"x 12"	Grey with Brown & White Fleck	-	Non ACM	SL	S37abc	13-Mar-08	ND

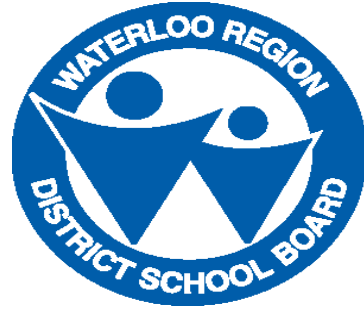

<b>School Name</b> <b>Waterloo-Oxford District Secondary School</b> <b>Date Built:</b> Original: 1955 Addition(s): 1958, 1962, 1966, 1971, 1972, 2000, 2001, 2011	<b>Legend:</b> <b>HM</b> - Homogenous Material - homogeneous with previously sampled material <b>SL</b> - Sample Location - Material Sampled <b>VC</b> - Visually Confirmed - Material not sampled, deemed ACM <b>NF</b> - Non-Friable <b>F</b> - Friable	<b>Notes:</b> All quantities provided on Figures, if known. Refer to the Asbestos Audit Update Report for condition of ACM and recommended actions. Dates provided in Material Description/Room Description columns indicates date of installation/renovation and confirms the finishes as non-ACM.
---	--	---

WRDSB Fixed Reference Number	Room Description	Inspected Item	Inspected Material	Material Description	Friability	Asbestos Classification	Sample / Identification Summary	Sample ID	Sample Date	% Asbestos & Fibre Type
312	Washroom	Wall	Concrete	-	-	Non ACM	-	-	-	-
312	Washroom	Ceiling	Ceiling Tile 2 x 2	Large & Small Pinhole (Drywall)	-	Non ACM	-	-	-	-
312	Washroom	Piping	Pipe Insulation	Fibreglass insulation	-	Non ACM	-	-	-	-
313	Storage	Floor	Vinyl Floor Tile 12"x 12"	Orange with White Fleck	NF	ACM	HM	S30	13-Mar-08	5.0% Chrysotile
313	Storage	Wall	Concrete	-	-	Non ACM	-	-	-	-
313	Storage	Ceiling	Plaster	-	-	Non ACM	HM	S24, S72, S82	13-Mar-08	ND
314	Storage	Floor	Vinyl Floor Tile 12"x 12"	Beige Dense Fleck (Post 2010)	-	Non ACM	-	-	-	-
314	Storage	Floor	Concrete	-	-	Non ACM	-	-	-	-
314	Storage	Wall	Concrete	-	-	Non ACM	-	-	-	-
314	Storage	Wall	Plaster	-	-	Non ACM	HM	S24, S72, S82	13-Mar-08	ND
314	Storage	Ceiling	Ceiling Tile 2' x 4'	Short Fissure Random Pinhole (Post 2010)	-	Non ACM	-	-	-	-
314	Storage	Ceiling	Concrete	-	-	Non ACM	-	-	-	-
315	Storage to Washroom	Floor	Vinyl Floor Tile 12"x 12"	Orange with White Fleck	NF	ACM	HM	S30	13-Mar-08	5.0% Chrysotile
315	Storage to Washroom	Wall	Concrete	-	-	Non ACM	-	-	-	-
315	Storage to Washroom	Ceiling	Plaster	-	-	Non ACM	HM	S24, S72, S82	13-Mar-08	ND
315A	Washroom	Floor	Vinyl Floor Tile 12"x 12"	Orange with White Fleck	NF	ACM	HM	S30	13-Mar-08	5.0% Chrysotile
315A	Washroom	Wall	Concrete	-	-	Non ACM	-	-	-	-
315A	Washroom	Ceiling	Plaster	-	-	Non ACM	HM	S24, S72, S82	13-Mar-08	ND
315A	Washroom	Piping	Pipe Fitting	Parged Cement	F	ACM	HM	1680.894.03	11-Sep-90	50-75% Chrysotile
316	Office	Floor	Vinyl Floor Tile 12"x 12"	Grey with Brown & White Fleck	-	Non ACM	HM	S37	13-Mar-08	ND
316	Office	Wall	Concrete	-	-	Non ACM	-	-	-	-
316	Office	Ceiling	Ceiling Tile 2 x 2	Large & Small Pinhole (Drywall)	-	Non ACM	-	-	-	-
317	Kitchen/Dishwasher	Floor	Vinyl Floor Tile 12"x 12"	Grey with Brown & White Fleck	-	Non ACM	HM	S37	13-Mar-08	ND
317	Kitchen/Dishwasher	Wall	Concrete	-	-	Non ACM	-	-	-	-
317	Kitchen/Dishwasher	Ceiling	Ceiling Tile 2' x 2'	Solid Pattern	-	Non ACM	SL	S38abc	13-Mar-08	ND
317	Kitchen/Dishwasher	Ceiling	Ceiling Tile 2' x 2'	Short Fissure Random Pinhole (1994)	-	Non ACM	-	-	-	-
317	Kitchen/Dishwasher	Above Ceiling	Texture Coat	-	F	ACM	HM	S39	13-Mar-08	20% Chrysotile
318	Staff Dining	Floor	Vinyl Sheet Flooring	Grey Cloudy (Post 2018)	-	Non ACM	-	-	-	-
318	Staff Dining	Wall	Concrete	-	-	Non ACM	-	-	-	-
318	Staff Dining	Ceiling	Plaster	-	-	Non ACM	SL	S41abc	13-Mar-08	ND
318	Staff Dining	Above Ceiling	Texture Coat	-	F	ACM	HM	S39	13-Mar-08	20% Chrysotile
318	Staff Dining	Piping	Pipe Insulation	Fibreglass insulation	-	Non ACM	-	-	-	-





<b>School Name</b> <b>Waterloo-Oxford District Secondary School</b> <b>Date Built:</b> Original: 1955 Addition(s): 1958, 1962, 1966, 1971, 1972, 2000, 2001, 2011	<b>Legend:</b> <b>HM</b> - Homogenous Material - homogeneous with previously sampled material <b>SL</b> - Sample Location - Material Sampled <b>VC</b> - Visually Confirmed - Material not sampled, deemed ACM <b>NF</b> - Non-Friable <b>F</b> - Friable	<b>Notes:</b> All quantities provided on Figures, if known. Refer to the Asbestos Audit Update Report for condition of ACM and recommended actions.  Dates provided in Material Description/Room Description columns indicates date of installation/renovation and confirms the finishes as non-ACM.
---	--	---

WRDSB Fixed Reference Number	Room Description	Inspected Item	Inspected Material	Material Description	Friability	Asbestos Classification	Sample / Identification Summary	Sample ID	Sample Date	% Asbestos & Fibre Type
319	Servery	Floor	Vinyl Floor Tile 12"x 12"	Grey with Brown & White Fleck	-	Non ACM	HM	S37	13-Mar-08	ND
319	Servery	Wall	Ceramic Tile	-	-	Non ACM	-	-	-	-
319	Servery	Ceiling	Ceiling Tile 2' x 2'	Solid Pattern	-	Non ACM	SL	S38abc	13-Mar-08	ND
319	Servery	Ceiling	Ceiling Tile 2' x 2'	Short Fissure Random Pinhole (1994)	-	Non ACM	-	-	-	-
319	Servery	Piping	Pipe Insulation	Fibreglass insulation	-	Non ACM	-	-	-	-
320	Servery	Floor	Terrazzo	-	-	Non ACM	-	-	-	-
320	Servery	Wall	Plaster	-	-	Non ACM	HM	S24, S72, S82	13-Mar-08	ND
320	Servery	Ceiling	Ceiling Tile 2 x 2	Large & Small Pinhole (Drywall)	-	Non ACM	-	-	-	-
321	Custodial Room	Floor	Terrazzo	-	-	Non ACM	-	-	-	-
321	Custodial Room	Wall	Concrete	-	-	Non ACM	-	-	-	-
321	Custodial Room	Ceiling	Plaster	-	-	Non ACM	HM	S24, S72, S82	13-Mar-08	ND
323	Cafetorium	Floor	Vinyl Floor Tile 12"x 12"	Black with Specks (Post 2010)	-	Non ACM	-	-	-	-
323	Cafetorium	Floor	Vinyl Floor Tile 12"x 12"	Beige with Specks (Post 2010)	-	Non ACM	-	-	-	-
323	Cafetorium	Floor	Vinyl Floor Tile 12"x 12"	Grey with Specks (Post 2010)	-	Non ACM	-	-	-	-
323	Cafetorium	Floor	Vinyl Floor Tile 12"x 12"	Green with Specks (Post 2010)	-	Non ACM	-	-	-	-
323	Cafetorium	Wall	Concrete	-	-	Non ACM	-	-	-	-
323	Cafetorium	Ceiling	Ceiling Tile 2' x 2'	Dense Fissure Small Pinhole	-	Non ACM	SL	S29abc	13-Mar-08	ND
323	Cafetorium	Piping	Pipe Insulation	Fibreglass insulation	-	Non ACM	-	-	-	-
323A	Stage	Floor	Wood	-	-	Non ACM	-	-	-	-
323A	Stage	Wall	Concrete	-	-	Non ACM	-	-	-	-
323A	Stage	Wall	Plaster	-	-	Non ACM	HM	S24, S72, S82	13-Mar-08	ND
323A	Stage	Piping	Pipe Fitting	Parged Cement	F	ACM	HM	1680.894.03	11-Sep-90	50-75% Chrysotile
323A	Stage	Piping	Pipe Insulation	Fibreglass insulation	-	Non ACM	-	-	-	-
323B	Stage	Floor	Concrete	-	-	Non ACM	-	-	-	-
323B	Stage	Wall	Concrete	-	-	Non ACM	-	-	-	-
323B	Stage	Wall	Plaster	-	-	Non ACM	HM	S24, S72, S82	13-Mar-08	ND
323B	Stage	Piping	Pipe Fitting	Parged Cement	F	ACM	HM	1680.894.03	11-Sep-90	50-75% Chrysotile
323B	Stage	Piping	Pipe Insulation	Fibreglass insulation	-	Non ACM	-	-	-	-
400A	Washroom	Floor	Terrazzo	-	-	Non ACM	-	-	-	-
400A	Washroom	Wall	Concrete	-	-	Non ACM	-	-	-	-
400A	Washroom	Wall	Ceramic Tile	-	-	Non ACM	-	-	-	-
400A	Washroom	Ceiling	Ceiling Tile 2' x 4'	Thick Fissure	-	Non ACM	SL	S65abc	-	-



	<b>School Name</b>	<b>Legend:</b>	<b>Notes:</b>
	Waterloo-Oxford District Secondary School	<b>HM</b> - Homogenous Material - homogeneous with previously sampled material <b>SL</b> - Sample Location - Material Sampled <b>VC</b> - Visually Confirmed - Material not sampled, deemed ACM <b>NF</b> - Non-Friable <b>F</b> - Friable	<b>All quantities provided on Figures, if known. Refer to the Asbestos Audit Update Report for condition of ACM and recommended actions.</b>
	<b>Date Built:</b>		
	Original: 1955		<b>Dates provided in Material Description/Room Description columns indicates date of installation/renovation and confirms the finishes as non-ACM.</b>
Addition(s): 1958, 1962, 1966, 1971, 1972, 2000, 2001, 2011			

WRDSB Fixed Reference Number	Room Description	Inspected Item	Inspected Material	Material Description	Friability	Asbestos Classification	Sample / Identification Summary	Sample ID	Sample Date	% Asbestos & Fibre Type
400B	Office	Floor	Terrazzo	-	-	Non ACM	-	-	-	-
400B	Office	Wall	Concrete	-	-	Non ACM	-	-	-	-
400B	Office	Wall	Ceramic Tile	-	-	Non ACM	-	-	-	-
400B	Office	Ceiling	Ceiling Tile 2' x 4'	Textured Pinhole	-	Non ACM	SL	S10abc	10-May-18	ND
400B	Office	Ceiling	Ceiling Tile 1' x 1'	Large and Small	-	Non ACM	HM	S10	10-Mar-08	ND
400B	Office	Piping	Pipe Insulation	Fiberglass insulation	-	Non ACM	-	-	-	-
400D	Storage	Floor	Concrete	-	-	Non ACM	-	-	-	-
400D	Storage	Wall	Plaster	-	-	Non ACM	HM	S64	10-Mar-08	ND
400D	Storage	Ceiling	Plaster	-	-	Non ACM	HM	S64	10-Mar-08	ND
401	Gymnasium	Floor	Wood	-	-	Non ACM	-	-	-	-
401	Gymnasium	Wall	Concrete	-	-	Non ACM	-	-	-	-
401	Gymnasium	Ceiling	Metal Pan	-	-	Non ACM	-	-	-	-
401	Gymnasium	Ceiling	Plaster	-	-	Non ACM	HM	S82	13-Mar-08	ND
401A	Storage	Floor	Vinyl Floor Tile 12"x 12"	Grey Dense Fleck (Post 2010)	-	Non ACM	-	-	-	-
401A	Storage	Wall	Concrete	-	-	Non ACM	-	-	-	-
401A	Storage	Wall	Brick	-	-	Non ACM	-	-	-	-
401A	Storage	Ceiling	Wood	-	-	Non ACM	-	-	-	-
401A	Storage	Piping	Pipe Fitting	Parged Cement	F	ACM	HM	1680.894.03	11-Sep-90	50-75% Chrysotile
401B	Office	Floor	Vinyl Floor Tile 12"x 12"	Grey Dense Fleck (Post 2010)	-	Non ACM	-	-	-	-
401B	Office	Wall	Plaster	-	-	Non ACM	HM	S82	13-Mar-08	ND
401B	Office	Ceiling	Plaster	-	-	Non ACM	HM	S82	13-Mar-08	ND
401C	Washroom	Floor	Vinyl Floor Tile 12"x 12"	Grey Dense Fleck (Post 2010)	-	Non ACM	-	-	-	-
401C	Washroom	Wall	Plaster	-	-	Non ACM	HM	S82	13-Mar-08	ND
401C	Washroom	Ceiling	Plaster	-	-	Non ACM	HM	S82	13-Mar-08	ND
401C	Washroom	Piping	Pipe Fitting	Parged Cement	F	ACM	HM	1680.894.03	11-Sep-90	50-75% Chrysotile
401D	Football Storage Room	Floor	Concrete	-	-	Non ACM	-	-	-	-
401D	Football Storage Room	Wall	Concrete	-	-	Non ACM	-	-	-	-
401D	Football Storage Room	Ceiling	Concrete	-	-	Non ACM	-	-	-	-
401D	Football Storage Room	Piping	Pipe Fitting	Fiberglass/PVC	-	Non ACM	-	-	-	-
402	Gymnasium	Floor	Wood	-	-	Non ACM	-	-	-	-
402	Gymnasium	Wall	Concrete	-	-	Non ACM	-	-	-	-
402	Gymnasium	Ceiling	Metal Pan	-	-	Non ACM	-	-	-	-

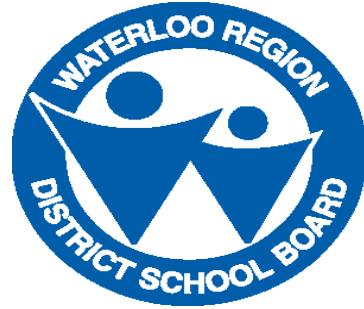

<b>School Name</b> <b>Waterloo-Oxford District Secondary School</b> <b>Date Built:</b> Original: 1955 Addition(s): 1958, 1962, 1966, 1971, 1972, 2000, 2001, 2011	<b>Legend:</b> HM - Homogenous Material - homogeneous with previously sampled material SL - Sample Location - Material Sampled VC - Visually Confirmed - Material not sampled, deemed ACM NF - Non-Friable F- Friable	<b>Notes:</b> All quantities provided on Figures, if known. Refer to the Asbestos Audit Update Report for condition of ACM and recommended actions. Dates provided in Material Description/Room Description columns indicates date of installation/renovation and confirms the finishes as non-ACM.
---	--	---

WRDSB Fixed Reference Number	Room Description	Inspected Item	Inspected Material	Material Description	Friability	Asbestos Classification	Sample / Identification Summary	Sample ID	Sample Date	% Asbestos & Fibre Type
402	Gymnasium	Ceiling	Plaster	-	-	Non ACM	HM	S82	13-Mar-08	ND
402A	Weight Room	Floor	Rubber	-	-	Non ACM	-	-	-	-
402A	Weight Room	Floor	Concrete	-	-	Non ACM	-	-	-	-
402A	Weight Room	Wall	Concrete	-	-	Non ACM	-	-	-	-
402A	Weight Room	Wall	Drywall	Drywall Joint Compound	NF	ACM	HM	S61	10-Mar-08	1.3% Chrysotile
402A	Weight Room	Ceiling	Drywall	Drywall Joint Compound	NF	ACM	HM	S61	10-Mar-08	1.3% Chrysotile
402B	Gym Storage	Floor	Vinyl Floor Tile 12"x 12"	Blue with Blue and White Fleck	NF	ACM	-	-	-	-
402B	Gym Storage	Wall	Concrete	-	-	Non ACM	-	-	-	-
402B	Gym Storage	Ceiling	Drywall	Drywall Joint Compound	NF	ACM	HM	S61	10-Mar-08	1.3% Chrysotile
402A	Gym Storage	Floor	Terrazzo	-	-	Non ACM	-	-	-	-
402A	Gym Storage	Wall	Concrete	-	-	Non ACM	-	-	-	-
402A	Gym Storage	Wall	Plaster	-	-	Non ACM	SL	S64abc	10-Mar-08	ND
402A	Gym Storage	Wall	Plaster	-	-	Non ACM	HM	S64	10-Mar-08	ND
402B	Gym Storage	Floor	Terrazzo	-	-	Non ACM	-	-	-	-
402B	Gym Storage	Wall	Concrete	-	-	Non ACM	-	-	-	-
402B	Gym Storage	Wall	Plaster	-	-	Non ACM	SL	S64abc	10-Mar-08	ND
402B	Gym Storage	Wall	Plaster	-	-	Non ACM	HM	S64	10-Mar-08	ND
402C	Gym Storage	Floor	Terrazzo	-	-	Non ACM	-	-	-	-
402C	Gym Storage	Wall	Concrete	-	-	Non ACM	-	-	-	-
402C	Gym Storage	Wall	Plaster	-	-	Non ACM	SL	S64abc	10-Mar-08	ND
402C	Gym Storage	Wall	Plaster	-	-	Non ACM	HM	S64	10-Mar-08	ND
402C	Electrical Room	Not Inspected								
403	Gym	Floor	Hardwood	-	-	Non ACM	-	-	-	-
403	Gym	Wall	Concrete	-	-	Non ACM	-	-	-	-
403	Gym	Deck	Metal Pan	Steel	-	Non ACM	-	-	-	-
403	Gym	Piping	Pipe Fitting	Parged Cement	F	ACM	HM	1680.894.03	11-Sep-90	50-75% Chrysotile
403A	Storage	Floor	Concrete	-	-	Non ACM	-	-	-	-
403A	Storage	Wall	Plaster	-	-	Non ACM	SL	S64abc	10-Mar-08	ND
403A	Storage	Wall	Plaster	-	-	Non ACM	HM	S64	10-Mar-08	ND
403B	Changeroom	Floor	Terrazzo	-	-	Non ACM	-	-	-	-
403B	Changeroom	Wall	Concrete	-	-	Non ACM	-	-	-	-
403B	Changeroom	Ceiling	Ceiling Tile 1' x 1'	Large and Small	-	Non ACM	HM	S10	10-Mar-08	ND

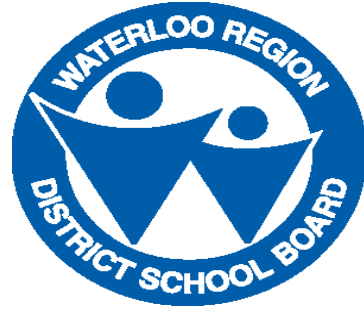

<b>School Name</b> <b>Waterloo-Oxford District Secondary School</b> <b>Date Built:</b> Original: 1955 Addition(s): 1958, 1962, 1966, 1971, 1972, 2000, 2001, 2011	<b>Legend:</b> HM - Homogenous Material - homogeneous with previously sampled material SL - Sample Location - Material Sampled VC - Visually Confirmed - Material not sampled, deemed ACM NF - Non-Friable F- Friable	<b>Notes:</b> All quantities provided on Figures, if known. Refer to the Asbestos Audit Update Report for condition of ACM and recommended actions. Dates provided in Material Description/Room Description columns indicates date of installation/renovation and confirms the finishes as non-ACM.
---	--	---

WRDSB Fixed Reference Number	Room Description	Inspected Item	Inspected Material	Material Description	Friability	Asbestos Classification	Sample / Identification Summary	Sample ID	Sample Date	% Asbestos & Fibre Type
403B	Changeroom	Ceiling	Ceiling Tile 2' x 4'	Short Fissure Small Pinhole	-	Non ACM	SL	S01ABC	10-May-18	ND
403B	Changeroom	Piping	Pipe Insulation	Fiberglass insulation	-	Non ACM	-	-	-	-
403C	Changeroom	Floor	Ceramic Tile	-	-	Non ACM	-	-	-	-
403C	Changeroom	Wall	Concrete	-	-	Non ACM	-	-	-	-
403C	Changeroom	Ceiling	Ceiling Tile 1' x 1'	Large and Small	-	Non ACM	HM	S10	10-Mar-08	ND
403C	Changeroom	Ceiling	Ceiling Tile 2' x 4'	Short Fissure Small Pinhole	-	Non ACM	SL	S01ABC	10-May-18	ND
403C	Changeroom	Piping	Pipe Insulation	Fiberglass insulation	-	Non ACM	-	-	-	-
403D	Changeroom	Wall	Concrete	-	-	Non ACM	-	-	-	-
403D	Changeroom	Ceiling	Ceiling Tile 1' x 1'	Large and Small	-	Non ACM	HM	S10	10-Mar-08	ND
403D	Changeroom	Ceiling	Ceiling Tile 2' x 4'	Short Fissure Small Pinhole	-	Non ACM	SL	S01ABC	10-May-18	ND
403D	Changeroom	Piping	Pipe Insulation	Fiberglass insulation	-	Non ACM	-	-	-	-
403E	Changeroom	Floor	Terrazzo	-	-	Non ACM	-	-	-	-
403E	Changeroom	Wall	Concrete	-	-	Non ACM	-	-	-	-
403E	Changeroom	Ceiling	Ceramic Tile	-	-	Non ACM	-	-	-	-
403E	Changeroom	Piping	Pipe Insulation	Fiberglass insulation	-	Non ACM	-	-	-	-
403F	Changeroom	Floor	Terrazzo	-	-	Non ACM	-	-	-	-
403F	Changeroom	Wall	Concrete	-	-	Non ACM	-	-	-	-
403F	Changeroom	Ceiling	Ceramic Tile	-	-	Non ACM	-	-	-	-
403F	Changeroom	Piping	Pipe Insulation	Fiberglass insulation	-	Non ACM	-	-	-	-
403G	Changeroom	Floor	Terrazzo	-	-	Non ACM	-	-	-	-
403G	Changeroom	Wall	Concrete	-	-	Non ACM	-	-	-	-
403G	Changeroom	Ceiling	Ceiling Tile 1' x 1'	Large and Small	-	Non ACM	HM	S10	10-Mar-08	ND
403G	Changeroom	Ceiling	Ceiling Tile 2' x 4'	Short Fissure Small Pinhole	-	Non ACM	HM	S01	10-May-18	ND
403G	Changeroom	Piping	Pipe Insulation	Fiberglass insulation	-	Non ACM	-	-	-	-
404	Music	Floor	Vinyl Floor Tile 9"x 9"	Tan with White & Black Fleck	NF	ACM	SL	S26abc	13-Mar-08	0.75% Chrysotile
404	Music	Floor	Vinyl Floor Tile 12"x 12"	Teal Dense Fleck	-	Non ACM	SL	S07	13-Mar-08	ND
404	Music	Wall	Plaster	-	-	Non ACM	HM	S24, S72, S82	13-Mar-08	ND
404	Music	Wall	Concrete	-	-	Non ACM	-	-	-	-
404	Music	Ceiling	Ceiling Tile 2' x 4'	Short Fissure Random Pinhole (Post 2020)	-	Non ACM	-	-	-	-
404	Music	Ceiling	Ceiling Tile 1' x 1'	Medium and Small Pinhole	NF	ACM	HM	S12	10-Mar-08	2.1% Amosite
404	Music	Piping	Pipe Fitting	Parged Cement	F	ACM	HM	1680.894.03	11-Sep-90	50-75% Chrysotile
404A	Practice Room	Floor	Vinyl Floor Tile 9"x 9"	Tan with White & Black Fleck	NF	ACM	HM	S26	13-Mar-08	0.75% Chrysotile



<b>School Name</b> <b>Waterloo-Oxford District Secondary School</b> <b>Date Built:</b> Original: 1955 Addition(s): 1958, 1962, 1966, 1971, 1972, 2000, 2001, 2011	<b>Legend:</b> HM - Homogenous Material - homogeneous with previously sampled material SL - Sample Location - Material Sampled VC - Visually Confirmed - Material not sampled, deemed ACM NF - Non-Friable F- Friable	<b>Notes:</b> All quantities provided on Figures, if known. Refer to the Asbestos Audit Update Report for condition of ACM and recommended actions. Dates provided in Material Description/Room Description columns indicates date of installation/renovation and confirms the finishes as non-ACM.
---	--	---

WRDSB Fixed Reference Number	Room Description	Inspected Item	Inspected Material	Material Description	Friability	Asbestos Classification	Sample / Identification Summary	Sample ID	Sample Date	% Asbestos & Fibre Type
404A	Practice Room	Wall	Plaster	-	-	Non ACM	HM	S24, S72, S82	13-Mar-08	ND
404A	Practice Room	Wall	Concrete	-	-	Non ACM	-	-	-	-
404A	Practice Room	Ceiling	Ceiling Tile 1' x 1'	Medium and Small Pinhole	NF	ACM	HM	S12	10-Mar-08	2.1% Amosite
404B	Practice Room	Floor	Vinyl Floor Tile 9"x 9"	Tan with White & Black Fleck	NF	ACM	HM	S26	13-Mar-08	0.75% Chrysotile
404B	Practice Room	Wall	Plaster	-	-	Non ACM	HM	S24, S72, S82	13-Mar-08	ND
404B	Practice Room	Wall	Concrete	-	-	Non ACM	-	-	-	-
404B	Practice Room	Ceiling	Ceiling Tile 1' x 1'	Medium and Small Pinhole	NF	ACM	HM	S12	10-Mar-08	2.1% Amosite
404C	Practice Room	Floor	Vinyl Floor Tile 9"x 9"	Tan with White & Black Fleck	NF	ACM	HM	S26	13-Mar-08	0.75% Chrysotile
404C	Practice Room	Wall	Plaster	-	-	Non ACM	HM	S24, S72, S82	13-Mar-08	ND
404C	Practice Room	Ceiling	Ceiling Tile 2' x 4'	Short Fissure Random Pinhole (Post 2020)	-	Non ACM	-	-	-	-
404C	Practice Room	Ceiling	Ceiling Tile 1' x 1'	Medium and Small Pinhole	NF	ACM	HM	S12	10-Mar-08	2.1% Amosite
404D	Practice Room	Floor	Vinyl Floor Tile 9"x 9"	Tan with White & Black Fleck	NF	ACM	HM	S26	13-Mar-08	0.75% Chrysotile
404D	Practice Room	Wall	Plaster	-	-	Non ACM	HM	S24, S72, S82	13-Mar-08	ND
404D	Practice Room	Ceiling	Ceiling Tile 2' x 4'	Short Fissure Random Pinhole (Post 2020)	-	Non ACM	-	-	-	-
404D	Practice Room	Ceiling	Ceiling Tile 1' x 1'	Medium and Small Pinhole	NF	ACM	HM	S12	10-Mar-08	2.1% Amosite
404E	Practice Room	Floor	Vinyl Floor Tile 9"x 9"	Tan with White & Black Fleck	NF	ACM	HM	S26	13-Mar-08	0.75% Chrysotile
404E	Practice Room	Floor	Concrete	-	-	Non ACM	-	-	-	-
404E	Practice Room	Wall	Drywall	Drywall Joint Compound	NF	ACM	HM	S07	10-Mar-08	1.8% Chrysotile
404E	Practice Room	Ceiling	Ceiling Tile 2' x 4'	Short Fissure Random Pinhole (Post 2020)	-	Non ACM	-	-	-	-
404E	Practice Room	Ceiling	Ceiling Tile 1' x 1'	Medium and Small Pinhole	NF	ACM	HM	S12	10-Mar-08	2.1% Amosite
404F	Practice Room	Floor	Vinyl Floor Tile 9"x 9"	Tan with White & Black Fleck	NF	ACM	HM	S26	13-Mar-08	0.75% Chrysotile
404F	Practice Room	Floor	Concrete	-	-	Non ACM	-	-	-	-
404F	Practice Room	Wall	Drywall	Drywall Joint Compound	NF	ACM	HM	S07	10-Mar-08	1.8% Chrysotile
404F	Practice Room	Ceiling	Ceiling Tile 2' x 4'	Short Fissure Random Pinhole (Post 2020)	-	Non ACM	-	-	-	-
404F	Practice Room	Ceiling	Ceiling Tile 1' x 1'	Medium and Small Pinhole	NF	ACM	HM	S12	10-Mar-08	2.1% Amosite
405	Classroom	Floor	Carpet	-	-	Non ACM	-	-	-	-
405	Classroom	Floor	Vinyl Floor Tile 9"x 9"	Beige with Grey Fleck	-	Non ACM	SL	S25abc	13-Mar-08	Trace Chrysotile
405	Classroom	Wall	Plaster	-	-	Non ACM	HM	S24	13-Mar-08	ND
405	Classroom	Wall	Concrete	-	-	Non ACM	-	-	-	-
405	Classroom	Ceiling	Ceiling Tile 2' x 4'	Short Fissure Random Pinhole (Post 2020)	-	Non ACM	-	-	-	-
405	Classroom	Ceiling	Ceiling Tile 1' x 1'	Medium and Small Pinhole	NF	ACM	HM	S12	10-Mar-08	2.1% Amosite
405	Classroom	Piping	Pipe Fitting	Parged Cement	F	ACM	HM	1680.894.03	11-Sep-90	50-75% Chrysotile



<b>School Name</b> <b>Waterloo-Oxford District Secondary School</b> <b>Date Built:</b> Original: 1955 Addition(s): 1958, 1962, 1966, 1971, 1972, 2000, 2001, 2011	<b>Legend:</b> <b>HM</b> - Homogenous Material - homogeneous with previously sampled material <b>SL</b> - Sample Location - Material Sampled <b>VC</b> - Visually Confirmed - Material not sampled, deemed ACM <b>NF</b> - Non-Friable <b>F</b> - Friable	<b>Notes:</b> All quantities provided on Figures, if known. Refer to the Asbestos Audit Update Report for condition of ACM and recommended actions. Dates provided in Material Description/Room Description columns indicates date of installation/renovation and confirms the finishes as non-ACM.
---	--	---

WRDSB Fixed Reference Number	Room Description	Inspected Item	Inspected Material	Material Description	Friability	Asbestos Classification	Sample / Identification Summary	Sample ID	Sample Date	% Asbestos & Fibre Type
405A	Workroom	Floor	Vinyl Floor Tile 9"x 9"	Beige with Grey Fleck	-	Non ACM	SL	S25abc	13-Mar-08	Trace Chrysotile
405A	Workroom	Floor	Floor Tile Mastic	Black Mastic	-	-	HM	S26	13-Mar-08	Non Detect
405A	Workroom	Floor	Concrete	-	-	-	-	-	-	-
405A	Workroom	Wall	Plaster	-	-	Non ACM	HM	S24	13-Mar-08	ND
405A	Workroom	Ceiling	Ceiling Tile 2' x 4'	Short Fissure Random Pinhole (Post 2020)	-	-	-	-	-	-
405A	Workroom	Ceiling	Ceiling Tile 1' x 1'	Medium and Small Pinhole	NF	ACM	HM	S12	10-Mar-08	2.1% Amosite
409	Changeroom	Floor	Terrazzo	-	-	Non ACM	-	-	-	-
409	Changeroom	Wall	Concrete	-	-	Non ACM	-	-	-	-
409	Changeroom	Wall	Ceramic Tile	-	-	Non ACM	-	-	-	-
409	Changeroom	Ceiling	Concrete	-	-	Non ACM	-	-	-	-
409A	Changeroom	Floor	Terrazzo	-	-	Non ACM	-	-	-	-
409A	Changeroom	Wall	Concrete	-	-	Non ACM	-	-	-	-
409A	Changeroom	Wall	Ceramic Tile	-	-	Non ACM	-	-	-	-
409A	Changeroom	Ceiling	Concrete	-	-	Non ACM	-	-	-	-
409B	Washroom	Floor	Terrazzo	-	-	Non ACM	-	-	-	-
409B	Washroom	Wall	Concrete	-	-	Non ACM	-	-	-	-
409B	Washroom	Wall	Ceramic Tile	-	-	Non ACM	-	-	-	-
409B	Washroom	Ceiling	Concrete	-	-	Non ACM	-	-	-	-
410	Washroom	Floor	Terrazzo	-	-	Non ACM	-	-	-	-
410	Washroom	Wall	Concrete	-	-	Non ACM	-	-	-	-
410	Washroom	Wall	Ceramic Tile	-	-	Non ACM	-	-	-	-
410	Washroom	Ceiling	Concrete	-	-	Non ACM	-	-	-	-
410A	Changeroom	Floor	Terrazzo	-	-	Non ACM	-	-	-	-
410A	Changeroom	Wall	Concrete	-	-	Non ACM	-	-	-	-
410A	Changeroom	Wall	Ceramic Tile	-	-	Non ACM	-	-	-	-
410A	Changeroom	Ceiling	Concrete	-	-	Non ACM	-	-	-	-
410B	Changeroom	Floor	Terrazzo	-	-	Non ACM	-	-	-	-
410B	Changeroom	Wall	Concrete	-	-	Non ACM	-	-	-	-
410B	Changeroom	Wall	Ceramic Tile	-	-	Non ACM	-	-	-	-
410B	Changeroom	Ceiling	Concrete	-	-	Non ACM	-	-	-	-
410C	Tuck Shop	Floor	Vinyl Floor Tile 9"x 9"	Grey with White Streaks	NF	ACM	SL	S68abc	10-Mar-08	1.3% Chrysotile
410C	Tuck Shop	Wall	Plaster	-	-	Non ACM	HM	S82	13-Mar-08	ND

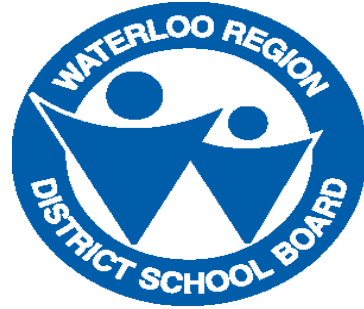

<b>School Name</b> <b>Waterloo-Oxford District Secondary School</b> <b>Date Built:</b> Original: 1955 Addition(s): 1958, 1962, 1966, 1971, 1972, 2000, 2001, 2011	<b>Legend:</b> HM - Homogenous Material - homogeneous with previously sampled material SL - Sample Location - Material Sampled VC - Visually Confirmed - Material not sampled, deemed ACM NF - Non-Friable F- Friable	<b>Notes:</b> All quantities provided on Figures, if known. Refer to the Asbestos Audit Update Report for condition of ACM and recommended actions. Dates provided in Material Description/Room Description columns indicates date of installation/renovation and confirms the finishes as non-ACM.
---	--	---

WRDSB Fixed Reference Number	Room Description	Inspected Item	Inspected Material	Material Description	Friability	Asbestos Classification	Sample / Identification Summary	Sample ID	Sample Date	% Asbestos & Fibre Type
410C	Tuck Shop	Ceiling	Ceiling Tile 1' x 1'	Large and Small	-	Non ACM	HM	S77	10-Mar-08	ND
500	Washroom	Floor	Terrazzo	-	-	Non ACM	-	-	-	-
500	Washroom	Wall	Concrete	-	-	Non ACM	-	-	-	-
500	Washroom	Wall	Plaster	-	-	Non ACM	HM	S24, S72, S82	13-Mar-08	ND
500	Washroom	Ceiling	Plaster	-	-	Non ACM	HM	S24, S72, S82	13-Mar-08	ND
500	Washroom	Piping	Pipe Fitting	Parged Cement	F	ACM	HM	1680.894.03	11-Sep-90	50-75% Chrysotile
500	Pipe Chase	Floor	Terrazzo	-	-	Non ACM	-	-	-	-
500	Pipe Chase	Wall	Plaster	-	-	Non ACM	HM	S24, S72, S82	13-Mar-08	ND
500	Pipe Chase	Ceiling	Ceiling Tile 1' x 1'	Large and Small Pinhole	-	Non ACM	HM	S04, S77	13-Mar-08	ND
500A	Washroom	Floor	Terrazzo	-	-	Non ACM	-	-	-	-
500A	Washroom	Wall	Plaster	-	-	Non ACM	HM	S24, S72, S82	13-Mar-08	ND
500A	Washroom	Wall	Concrete	-	-	Non ACM	-	-	-	-
500A	Washroom	Ceiling	Ceiling Tile 1' x 1'	Large and Small Pinhole	-	Non ACM	HM	S04, S77	13-Mar-08	ND
500A	Washroom	Piping	Pipe Fitting	Parged Cement	F	ACM	HM	1680.894.03	11-Sep-90	50-75% Chrysotile
501	Classroom	Floor	Vinyl Floor Tile 9"x 9"	Tan with Red and Black	NF	ACM	SL	S28abc	13-Mar-08	4.1% Chrysotile
501	Classroom	Wall	Plaster	-	-	Non ACM	HM	S24, S72, S82	13-Mar-08	ND
501	Classroom	Ceiling	Ceiling Tile 1' x 1'	Large and Small Pinhole	-	Non ACM	HM	S04, S77	13-Mar-08	ND
501	Classroom	Ceiling	Ceiling Tile 2' x 4'	Short Fissure Random Pinhole (Post 1994)	-	Non ACM	VC	-	-	-
501	Classroom	Piping	Pipe Fitting	Parged Cement	F	ACM	HM	1680.894.03	11-Sep-90	50-75% Chrysotile
502	Workroom	Floor	Vinyl Floor Tile 12"x 12"	White with Brown (Post 2010)	-	Non ACM	-	-	-	-
502	Workroom	Wall	Plaster	-	-	Non ACM	HM	S24, S72, S82	13-Mar-08	ND
502	Workroom	Wall	Drywall	Post 2010	-	Non ACM	-	-	-	-
502	Workroom	Ceiling	Ceiling Tile 1' x 1'	Large and Small Pinhole	-	Non ACM	HM	S04, S77	13-Mar-08	ND
502	Workroom	Ceiling	Ceiling Tile 2' x 4'	Short Fissure Random Pinhole (Post 1994)	-	Non ACM	VC	-	-	-
503	Classroom	Floor	Vinyl Floor Tile 9"x 9"	Tan with Red and Black	NF	ACM	HM	S28	13-Mar-08	4.1% Chrysotile
503	Classroom	Wall	Plaster	-	-	Non ACM	HM	S24, S72, S82	13-Mar-08	ND
503	Classroom	Ceiling	Ceiling Tile 1' x 1'	Large and Small Pinhole	-	Non ACM	HM	S04, S77	13-Mar-08	ND
503	Classroom	Ceiling	Ceiling Tile 2' x 4'	Short Fissure Random Pinhole (Post 1994)	-	Non ACM	VC	-	-	-
503	Classroom	Piping	Pipe Fitting	Parged Cement	F	ACM	HM	1680.894.03	11-Sep-90	50-75% Chrysotile
504	Workroom	Floor	Vinyl Floor Tile 12"x 12"	White with Brown (Post 2010)	-	Non ACM	-	-	-	-
504	Workroom	Wall	Plaster	-	-	Non ACM	HM	S24, S72, S82	13-Mar-08	ND
504	Workroom	Wall	Drywall	Post 2010	-	Non ACM	-	-	-	-

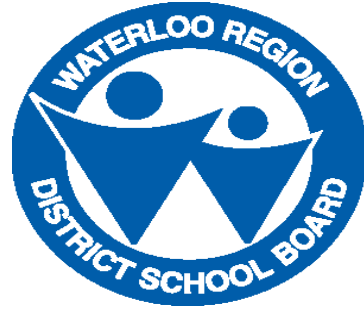

<b>School Name</b> <b>Waterloo-Oxford District Secondary School</b> <b>Date Built:</b> Original: 1955 Addition(s): 1958, 1962, 1966, 1971, 1972, 2000, 2001, 2011	<b>Legend:</b> <b>HM</b> - Homogenous Material - homogeneous with previously sampled material <b>SL</b> - Sample Location - Material Sampled <b>VC</b> - Visually Confirmed - Material not sampled, deemed ACM <b>NF</b> - Non-Friable <b>F</b> - Friable	<b>Notes:</b> All quantities provided on Figures, if known. Refer to the Asbestos Audit Update Report for condition of ACM and recommended actions. Dates provided in Material Description/Room Description columns indicates date of installation/renovation and confirms the finishes as non-ACM.
---	--	---

WRDSB Fixed Reference Number	Room Description	Inspected Item	Inspected Material	Material Description	Friability	Asbestos Classification	Sample / Identification Summary	Sample ID	Sample Date	% Asbestos & Fibre Type
504	Workroom	Ceiling	Ceiling Tile 1' x 1'	Large and Small Pinhole	-	Non ACM	HM	S04, S77	13-Mar-08	ND
504	Workroom	Ceiling	Ceiling Tile 2' x 4'	Short Fissure Random Pinhole (Post 1994)	-	Non ACM	-	-	-	-
504A	Storage	Floor	Vinyl Floor Tile 12"x 12"	White with Brown (Post 2010)	-	Non ACM	-	-	-	-
504A	Storage	Wall	Plaster	-	-	Non ACM	HM	S24, S72, S82	13-Mar-08	ND
504A	Storage	Wall	Wood	-	-	Non ACM	-	-	-	-
504A	Storage	Ceiling	Ceiling Tile 1' x 1'	Large and Small Pinhole	-	Non ACM	HM	S04, S77	13-Mar-08	ND
504B	Workroom	Floor	Vinyl Floor Tile 12"x 12"	White with Brown (Post 2010)	-	Non ACM	-	-	-	-
504B	Workroom	Wall	Plaster	-	-	Non ACM	HM	S24, S72, S82	13-Mar-08	ND
504B	Workroom	Wall	Drywall	Post 2010	-	Non ACM	-	-	-	-
504B	Workroom	Ceiling	Ceiling Tile 1' x 1'	Large and Small Pinhole	-	Non ACM	HM	S04, S77	13-Mar-08	ND
504B	Workroom	Ceiling	Ceiling Tile 2' x 4'	Short Fissure Random Pinhole (Post 1994)	-	Non ACM	-	-	-	-
505	Classroom	Floor	Vinyl Floor Tile 9"x 9"	Green with White Streaks	NF	ACM	HM	S21	13-Mar-08	0.5% Chrysotile
505	Classroom	Wall	Plaster	-	-	Non ACM	HM	S24, S72, S82	13-Mar-08	ND
505	Classroom	Ceiling	Ceiling Tile 1' x 1'	Large and Small Pinhole	-	Non ACM	HM	S04, S77	13-Mar-08	ND
505	Classroom	Ceiling	Ceiling Tile 2' x 4'	Short Fissure Random Pinhole (Post 1994)	-	Non ACM	-	-	-	-
505	Classroom	Deck	Metal Pan	Steel	-	Non ACM	-	-	-	-
505	Classroom	Piping	Pipe Fitting	Parged Cement	F	ACM	HM	1680.894.03	11-Sep-90	50-75% Chrysotile
506	Classroom	Floor	Vinyl Floor Tile 9"x 9"	Blue with White Streaks	-	Non ACM	SL	S20abc	10-Mar-08	0.5% Chrysotile
506	Classroom	Wall	Plaster	-	-	Non ACM	HM	S19	10-Mar-08	-
506	Classroom	Ceiling	Ceiling Tile 2' x 4'	Short Fissure Random Pinhole	-	Non ACM	HM	S01	10-May-18	ND
507	Classroom	Floor	Vinyl Sheet Flooring	Blue Dense Fleck (Post 2018)	-	Non ACM	-	-	-	-
507	Classroom	Wall	Plaster	-	-	Non ACM	HM	S19	10-Mar-08	-
507	Classroom	Ceiling	Ceiling Tile 2' x 4'	Short Fissure Random Pinhole	-	Non ACM	HM	S01	10-May-18	ND
508	Classroom	Floor	Vinyl Floor Tile 12"x 12"	Brown Oatmeal (Post 2010)	-	Non ACM	-	-	-	-
508	Classroom	Wall	Plaster	-	-	Non ACM	HM	S19	10-Mar-08	-
508	Classroom	Ceiling	Ceiling Tile 2' x 4'	Short Fissure Random Pinhole	-	Non ACM	HM	S01	10-May-18	ND
508	Classroom	Ceiling	Ceiling Tile 1' x 1'	Pattern/Date	-	Non ACM	-	-	-	-
508	Classroom	Wall	Metal Partition	-	-	Non ACM	-	-	-	-
509	Classroom	Floor	Vinyl Floor Tile 12"x 12"	Brown Oatmeal (Post 2010)	-	Non ACM	-	-	-	-
509	Classroom	Wall	Concrete	-	-	Non ACM	-	-	-	-
509	Classroom	Ceiling	Ceiling Tile 2' x 4'	Short Fissure Random Pinhole	-	Non ACM	HM	S01	10-May-18	ND
509A	Classroom	Floor	Vinyl Floor Tile 12"x 12"	Brown Oatmeal (Post 2010)	-	Non ACM	-	-	-	-





<b>School Name</b> <b>Waterloo-Oxford District Secondary School</b> <b>Date Built:</b> Original: 1955 Addition(s): 1958, 1962, 1966, 1971, 1972, 2000, 2001, 2011	<b>Legend:</b> HM - Homogenous Material - homogeneous with previously sampled material SL - Sample Location - Material Sampled VC - Visually Confirmed - Material not sampled, deemed ACM NF - Non-Friable F- Friable	<b>Notes:</b> All quantities provided on Figures, if known. Refer to the Asbestos Audit Update Report for condition of ACM and recommended actions. Dates provided in Material Description/Room Description columns indicates date of installation/renovation and confirms the finishes as non-ACM.
---	--	---

WRDSB Fixed Reference Number	Room Description	Inspected Item	Inspected Material	Material Description	Friability	Asbestos Classification	Sample / Identification Summary	Sample ID	Sample Date	% Asbestos & Fibre Type
509A	Classroom	Wall	Concrete	-	-	Non ACM	-	-	-	-
509A	Classroom	Wall	Drywall	Drywall Joint Compound (Post 2000)	-	Non ACM	-	-	-	-
509A	Classroom	Ceiling	Ceiling Tile 2' x 4'	Short Fissure Random Pinhole	-	Non ACM	HM	S01	10-May-18	ND
509B	Classroom	Floor	Vinyl Floor Tile 12"x 12"	Brown Oatmeal (Post 2010)	-	Non ACM	-	-	-	-
509B	Classroom	Wall	Concrete	-	-	Non ACM	-	-	-	-
509B	Classroom	Wall	Drywall	Drywall Joint Compound (Post 2010)	-	Non ACM	-	-	-	-
509B	Classroom	Ceiling	Ceiling Tile 2' x 4'	Short Fissure Random Pinhole	-	Non ACM	HM	S01	10-May-18	ND
510	Classroom	Floor	Concrete	-	-	Non ACM	-	-	-	-
510	Classroom	Wall	Concrete	-	-	Non ACM	-	-	-	-
510	Classroom	Wall	Plaster	-	-	Non ACM	SL	S03BC	10-May-18	ND
510	Classroom	Wall	Metal Partition	-	-	Non ACM	-	-	-	-
510	Classroom	Ceiling	Ceiling Tie	Fibreglass	-	Non ACM	-	-	-	-
510	Classroom	Piping	Pipe Fitting	Parged Cement	F	ACM	HM	1680.894.03	11-Sep-90	50-75% Chrysotile
510	Classroom	Ducting	Flex Joint	-	NF	ACM	VC	-	-	-
510A	Classroom	Floor	Concrete	-	-	Non ACM	-	-	-	-
510A	Classroom	Wall	Concrete	-	-	Non ACM	-	-	-	-
510A	Classroom	Wall	Metal Partition	-	-	Non ACM	-	-	-	-
510A	Classroom	Ceiling	Ceiling Tile 2' x 4'	Short Fissure Random Pinhole	-	Non ACM	HM	S01	10-May-18	ND
510A	Classroom	Piping	Pipe Fitting	Parged Cement	F	ACM	HM	1680.894.03	11-Sep-90	50-75% Chrysotile
511	Storage Room	Floor	Concrete	-	-	Non ACM	-	-	-	-
511	Storage Room	Wall	Plaster	-	-	Non ACM	HM	S02, S05, S19	10-Mar-08	ND
511	Storage Room	Wall	Concrete	-	-	Non ACM	-	-	-	-
511	Storage Room	Ceiling	Plaster	-	-	Non ACM	HM	S02, S05, S19	10-Mar-08	ND
511A	Cyclone Room	Floor	Concrete	-	-	Non ACM	-	-	-	-
511A	Cyclone Room	Wall	Concrete	-	-	Non ACM	-	-	-	-
511A	Cyclone Room	Ceiling	Metal Pan	Open Web Steel Joists	-	Non ACM	-	-	-	-
511B	Cyclone Room	Floor	Concrete	-	-	Non ACM	-	-	-	-
511B	Cyclone Room	Wall	Concrete	-	-	Non ACM	-	-	-	-
511B	Cyclone Room	Ceiling	Metal Pan	Open Web Steel Joists	-	Non ACM	-	-	-	-
511B	Cyclone Room	Mechanical	Cyclone	-	-	Non ACM	-	-	-	-
511C	Fan Room	Floor	Concrete	-	-	Non ACM	-	-	-	-
511C	Fan Room	Wall	Concrete	-	-	Non ACM	-	-	-	-



<b>School Name</b> <b>Waterloo-Oxford District Secondary School</b> <b>Date Built:</b> Original: 1955 Addition(s): 1958, 1962, 1966, 1971, 1972, 2000, 2001, 2011	<b>Legend:</b> HM - Homogenous Material - homogeneous with previously sampled material SL - Sample Location - Material Sampled VC - Visually Confirmed - Material not sampled, deemed ACM NF - Non-Friable F- Friable	<b>Notes:</b> All quantities provided on Figures, if known. Refer to the Asbestos Audit Update Report for condition of ACM and recommended actions. Dates provided in Material Description/Room Description columns indicates date of installation/renovation and confirms the finishes as non-ACM.
---	--	---

WRDSB Fixed Reference Number	Room Description	Inspected Item	Inspected Material	Material Description	Friability	Asbestos Classification	Sample / Identification Summary	Sample ID	Sample Date	% Asbestos & Fibre Type
511C	Fan Room	Wall	Brick	-	-	Non ACM	-	-	-	-
511C	Fan Room	Ceiling	Drywall	Drywall Joint Compound	NF	ACM	HM	S61	10-Mar-08	1.3% Chrysotile
511C	Fan Room	Ducting	Flex Joint	-	NF	ACM	VC	-	-	-
511D	Stairwell	Floor	Vinyl Floor Tile 12"x 12"	Brown Oatmeal (Post 2010)	-	Non ACM	-	-	-	-
511D	Stairwell	Wall	Concrete	-	-	Non ACM	-	-	-	-
511D	Stairwell	Piping	Pipe Insulation	Fiberglass insulation	-	Non ACM	-	-	-	-
511D	Stairwell	Piping	Pipe Fitting	Parged Cement	F	ACM	HM	1680.894.03	11-Sep-90	50-75% Chrysotile
511E	Stairwell	Floor	Vinyl Floor Tile 12"x 12"	Brown Oatmeal (Post 2010)	-	Non ACM	-	-	-	-
511E	Stairwell	Wall	Concrete	-	-	Non ACM	-	-	-	-
511E	Stairwell	Piping	Pipe Insulation	Fiberglass insulation	-	Non ACM	-	-	-	-
512	Classroom	Floor	Wood	-	-	Non ACM	-	-	-	-
512	Classroom	Floor	Vinyl Floor Tile 9"x 9"	Grey with White	NF	ACM	SL	S18abc	10-Mar-08	1.8% Chrysotile
512	Classroom	Wall	Concrete	-	-	Non ACM	-	-	-	-
512	Classroom	Ceiling	Ceiling Tile 2' x 4'	Short Fissure Random Pinhole	-	Non ACM	HM	S01	10-May-18	ND
512	Classroom	Ceiling	Ceiling Tile 2' x 4'	Long Fissure Random Pinhole	-	Non ACM	-	-	-	-
512	Classroom	Piping	Pipe Fitting	Parged Cement	F	ACM	HM	1680.894.03	11-Sep-90	50-75% Chrysotile
512B	Small Storage	Floor	Wood	-	-	Non ACM	-	-	-	-
512B	Small Storage	Wall	Plaster	-	-	Non ACM	SL	S03A	10-May-18	ND
512B	Small Storage	Ceiling	Ceiling Tile 1' x 1'	Cellulose	-	Non ACM	-	-	-	-
512C	Large Storage	Floor	Wood	-	-	Non ACM	-	-	-	-
512C	Large Storage	Wall	Plaster	-	-	Non ACM	HM	S03	10-May-18	ND
512C	Large Storage	Ceiling	Ceiling Tile 1' x 1'	Large Pinhole	-	Non ACM	HM	S10	10-May-18	ND
513	Media Room	Floor	Carpet	-	-	Non ACM	-	-	-	-
513	Media Room	Wall	Concrete	-	-	Non ACM	-	-	-	-
513	Media Room	Wall	Drywall	Drywall Joint Compound	NF	ACM	HM	S61	10-Mar-08	1.3% Chrysotile
513	Media Room	Ceiling	Ceiling Tile 2' x 4'	Short Fissure Random Pinhole	-	Non ACM	HM	S01	10-May-18	ND
513	Media Room	Piping	Pipe Fitting	Fiberglass/PVC	-	Non ACM	-	-	-	-
513A	Staff Room	Floor	Vinyl Floor Tile 12"x 12"	Tan with Brown	NF	ACM	SL	S15abc	10-Mar-08	3.6% Chrysotile
513A	Staff Room	Wall	Concrete	-	-	Non ACM	-	-	-	-
513A	Staff Room	Wall	Wood Panel	-	-	Non ACM	-	-	-	-
513A	Staff Room	Ceiling	Ceiling Tile 2' x 4'	Medium Fissure Random Pinhole	-	Non ACM	HM	S02ABC	10-May-18	ND
513A	Staff Room	Piping	Pipe Fitting	Parged Cement	F	ACM	HM	1680.894.03	11-Sep-90	50-75% Chrysotile



<b>School Name</b> <b>Waterloo-Oxford District Secondary School</b> <b>Date Built:</b> Original: 1955 Addition(s): 1958, 1962, 1966, 1971, 1972, 2000, 2001, 2011	<b>Legend:</b> <b>HM</b> - Homogenous Material - homogeneous with previously sampled material <b>SL</b> - Sample Location - Material Sampled <b>VC</b> - Visually Confirmed - Material not sampled, deemed ACM <b>NF</b> - Non-Friable <b>F</b> - Friable	<b>Notes:</b> All quantities provided on Figures, if known. Refer to the Asbestos Audit Update Report for condition of ACM and recommended actions. Dates provided in Material Description/Room Description columns indicates date of installation/renovation and confirms the finishes as non-ACM.
---	--	---

WRDSB Fixed Reference Number	Room Description	Inspected Item	Inspected Material	Material Description	Friability	Asbestos Classification	Sample / Identification Summary	Sample ID	Sample Date	% Asbestos & Fibre Type
513B	Staff Room	Floor	Vinyl Floor Tile 12"x 12"	Brown Dense Fleck (Post 2010)	-	Non ACM	-	-	-	-
513B	Staff Room	Wall	Concrete	-	-	Non ACM	-	-	-	-
513B	Staff Room	Ceiling	Ceiling Tile 1' x 1'	Large and Small Pinhole	-	Non ACM	HM	S04, S77	13-Mar-08	ND
513B	Staff Room	Piping	Pipe Insulation	Horsehair	-	Non ACM	-	-	-	-
513B	Staff Room	Piping	Pipe Fitting	Parged Cement	F	ACM	HM	1680.894.03	11-Sep-90	50-75% Chrysotile
513C	Closet	Floor	Vinyl Floor Tile 12"x 12"	White with Grey Fleck (Post 2010)	-	Non ACM	-	-	-	-
513C	Closet	Wall	Concrete	-	-	Non ACM	-	-	-	-
513C	Closet	Wall	Plaster	-	-	Non ACM	HM	S24, S72, S82	13-Mar-08	ND
513C	Closet	Ceiling	Ceiling Tile 2' x 4'	Short Fissure Random Pinhole	-	Non ACM	HM	S01	10-May-18	ND
513E	Storage Room	Floor	Vinyl Floor Tile 12"x 12"	White with Grey Fleck (Post 2010)	-	Non ACM	-	-	-	-
513E	Storage Room	Wall	Drywall	Drywall Joint Compound	NF	ACM	HM	S61	10-Mar-08	1.3% Chrysotile
513E	Storage Room	Ceiling	Ceiling Tile 2' x 4'	Short Fissure Random Pinhole	-	Non ACM	HM	S01	10-May-18	ND
513E	Storage Room	Piping	Pipe Fitting	Parged Cement	F	ACM	HM	1680.894.03	11-Sep-90	50-75% Chrysotile
514	Classroom	Floor	Wood	-	-	Non ACM	-	-	-	-
514	Classroom	Wall	Drywall	Drywall Joint Compound	NF	ACM	HM	S61	10-Mar-08	1.3% Chrysotile
514	Classroom	Wall	Concrete	-	-	Non ACM	-	-	-	-
514	Classroom	Ceiling	Ceiling Tile 2' x 4'	Random Fissures and Pinholes	-	Non ACM	SL	S13abc	10-Mar-08	ND
514	Classroom	Piping	Pipe Fitting	Parged Cement	F	ACM	HM	1680.894.03	11-Sep-90	50-75% Chrysotile
514A	Classroom	Floor	Carpet	-	-	Non ACM	-	-	-	-
514A	Classroom	Wall	Concrete	-	-	Non ACM	-	-	-	-
514A	Classroom	Wall	Drywall	Drywall Joint Compound	NF	ACM	HM	S61	10-Mar-08	1.3% Chrysotile
514A	Classroom	Wall	Ceiling Tile 1' x 1'	Acoustic Tiles	-	Non ACM	SL	S14abc	10-Mar-08	ND
514A	Classroom	Ceiling	Ceiling Tile 2' x 4'	Short Fissure Random Pinhole	-	Non ACM	HM	S01	10-May-18	ND
514A	Classroom	Piping	Pipe Fitting	Parged Cement	F	ACM	HM	1680.894.03	11-Sep-90	50-75% Chrysotile
514B	Storage Room	Floor	Carpet	-	-	Non ACM	-	-	-	-
514B	Storage Room	Wall	Concrete	-	-	Non ACM	-	-	-	-
514B	Storage Room	Wall	Drywall	Drywall Joint Compound	NF	ACM	HM	S61	10-Mar-08	1.3% Chrysotile
514B	Storage Room	Wall	Ceiling Tile 1' x 1'	Acoustic Tiles	-	Non ACM	HM	S14abc	10-Mar-08	ND
514B	Storage Room	Ceiling	Ceiling Tile 2' x 4'	Short Fissure Random Pinhole	-	Non ACM	HM	S01	10-May-18	ND
514E	Closet	Floor	Concrete	-	-	Non ACM	-	-	-	-
514E	Closet	Wall	Drywall	Post 2010	-	Non ACM	-	-	-	-
514E	Closet	Ceiling	Metal Pan	Open Web Steel Joists	-	Non ACM	-	-	-	-

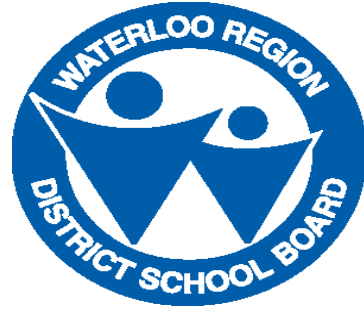

<b>School Name</b> <b>Waterloo-Oxford District Secondary School</b> <b>Date Built:</b> Original: 1955 Addition(s): 1958, 1962, 1966, 1971, 1972, 2000, 2001, 2011	<b>Legend:</b> HM - Homogenous Material - homogeneous with previously sampled material SL - Sample Location - Material Sampled VC - Visually Confirmed - Material not sampled, deemed ACM NF - Non-Friable F- Friable	<b>Notes:</b> All quantities provided on Figures, if known. Refer to the Asbestos Audit Update Report for condition of ACM and recommended actions.  Dates provided in Material Description/Room Description columns indicates date of installation/renovation and confirms the finishes as non-ACM.
---	--	---

WRDSB Fixed Reference Number	Room Description	Inspected Item	Inspected Material	Material Description	Friability	Asbestos Classification	Sample / Identification Summary	Sample ID	Sample Date	% Asbestos & Fibre Type
515	Classroom	Floor	Concrete	-	-	Non ACM	-	-	-	-
515	Classroom	Wall	Plaster	-	-	Non ACM	HM	S24, S43	10-Mar-08	ND
515	Classroom	Wall	Concrete	-	-	Non ACM	-	-	-	-
515	Classroom	Ceiling	Metal Pan	Open Web Steel Joists	-	Non ACM	-	-	-	-
515A	Classroom	Floor	Vinyl Floor Tile 9"x 9"	Brown with White Flecks	NF	ACM	HM	S09abc	10-Mar-08	1.3% Chrysotile
515A	Classroom	Wall	Plaster	-	-	Non ACM	HM	S24, S43	10-Mar-08	ND
515A	Classroom	Ceiling	Plaster	-	-	Non ACM	HM	S24, S43	10-Mar-08	ND
515B	Classroom	Floor	Vinyl Floor Tile 9"x 9"	Brown with White Flecks	NF	ACM	SL	S09abc	10-Mar-08	1.3% Chrysotile
515B	Classroom	Wall	Plaster	-	-	Non ACM	HM	S24, S43	10-Mar-08	ND
515B	Classroom	Ceiling	Plaster	-	-	Non ACM	HM	S24, S43	10-Mar-08	ND
515B	Classroom	Floor	Concrete	-	-	Non ACM	-	-	-	-
515B	Classroom	Wall	Plaster	-	-	Non ACM	HM	S24, S43	10-Mar-08	ND
515B	Classroom	Wall	Concrete	-	-	Non ACM	-	-	-	-
515B	Classroom	Ceiling	Ceiling Tile 1' x 1'	Large Pinhole	-	Non ACM	SL	S10abc	-	ND
515B	Classroom	Ceiling	Ceiling Tile 1' x 1'	Long Fissure Small Pinhole	-	Non ACM	SL	S11abc	-	ND
515B	Classroom	Piping	Pipe Fitting	Parged Cement	F	ACM	HM	1680.894.03	11-Sep-90	50-75% Chrysotile
516	Classroom	Floor	Wood	-	-	Non ACM	-	-	-	-
516	Classroom	Floor	Vinyl Floor Tile 9"x 9"	Tan with White & Black Fleck	NF	ACM	SL	S26abc	13-Mar-08	0.75% Chrysotile
516	Classroom	Wall	Drywall	Drywall Joint Compound	NF	ACM	SL	S07abc	10-Mar-08	1.8% Chrysotile
516	Classroom	Wall	Concrete	-	-	Non ACM	-	-	-	-
516	Classroom	Ceiling	Ceiling Tile 1' x 1'	Medium and Small Pinhole	NF	ACM	SL	S12abc	10-Mar-08	2.1% Amosite
516	Classroom	Piping	Pipe Fitting	Parged Cement	F	ACM	HM	1680.894.03	11-Sep-90	50-75% Chrysotile
516	Classroom	Piping	Pipe Insulation	Horsehair	-	Non ACM	-	-	-	-
516A	Small Store Room	Floor	Wood	-	-	Non ACM	-	-	-	-
516A	Small Store Room	Wall	Drywall	Drywall Joint Compound	NF	ACM	HM	S07	10-Mar-08	1.8% Chrysotile
516A	Small Store Room	Ceiling	Ceiling Tile 2' x 2'	Large Pinhole (Drywall)	-	Non ACM	-	-	-	-
516A	Small Store Room	Piping	Pipe Fitting	Parged Cement	F	ACM	HM	1680.894.03	11-Sep-90	50-75% Chrysotile
516B	Large Store Room	Floor	Wood	-	-	Non ACM	-	-	-	-
516B	Large Store Room	Wall	Drywall	Drywall Joint Compound	NF	ACM	HM	S07	10-Mar-08	1.8% Chrysotile
516B	Large Store Room	Wall	Concrete	-	-	Non ACM	-	-	-	-
516B	Large Store Room	Ceiling	Ceiling Tile 2' x 2'	Large Pinhole (Drywall)	-	Non ACM	-	-	-	-
516C	Store Room	Floor	Wood	-	-	Non ACM	-	-	-	-



<b>School Name</b> <b>Waterloo-Oxford District Secondary School</b> <b>Date Built:</b> Original: 1955 Addition(s): 1958, 1962, 1966, 1971, 1972, 2000, 2001, 2011	<b>Legend:</b> <b>HM</b> - Homogenous Material - homogeneous with previously sampled material <b>SL</b> - Sample Location - Material Sampled <b>VC</b> - Visually Confirmed - Material not sampled, deemed ACM <b>NF</b> - Non-Friable <b>F</b> - Friable	<b>Notes:</b> All quantities provided on Figures, if known. Refer to the Asbestos Audit Update Report for condition of ACM and recommended actions. Dates provided in Material Description/Room Description columns indicates date of installation/renovation and confirms the finishes as non-ACM.
---	--	---

WRDSB Fixed Reference Number	Room Description	Inspected Item	Inspected Material	Material Description	Friability	Asbestos Classification	Sample / Identification Summary	Sample ID	Sample Date	% Asbestos & Fibre Type
516C	Store Room	Wall	Drywall	Drywall Joint Compound	NF	ACM	SL	S07abc	10-Mar-08	1.8% Chrysotile
516C	Store Room	Wall	Concrete	-	-	Non ACM	-	-	-	-
516C	Store Room	Ceiling	Ceiling Tile 2' x 2'	Large Pinhole (Drywall)	-	Non ACM	-	-	-	-
517	Classroom	Floor	Concrete	-	-	Non ACM	-	-	-	-
517	Classroom	Floor	Wood	-	-	Non ACM	-	-	-	-
517	Classroom	Wall	Concrete	-	-	Non ACM	-	-	-	-
517	Classroom	Wall	Brick	-	-	Non ACM	-	-	-	-
517	Classroom	Ceiling	Ceiling Tile 2' x 4'	Short Fissure Random Pinhole (Post 2010)	-	Non ACM	-	-	-	-
517	Classroom	Piping	Pipe Fitting	Fiberglass/PVC	-	Non ACM	-	-	-	-
517	Classroom	Piping	Pipe Fitting	Cellulose	-	Non ACM	-	-	-	-
517A	Classroom	Floor	Concrete	-	-	Non ACM	-	-	-	-
517A	Classroom	Wall	Concrete	-	-	Non ACM	-	-	-	-
517A	Classroom	Ceiling	Concrete	-	-	Non ACM	-	-	-	-
518	Classroom	Floor	Concrete	-	-	Non ACM	-	-	-	-
518	Classroom	Wall	Concrete	-	-	Non ACM	-	-	-	-
518	Classroom	Wall	Drywall	Drywall Joint Compound	-	Non ACM	SL	S01abc	10-Mar-08	ND
518	Classroom	Wall	Brick	-	-	Non ACM	-	-	-	-
518	Classroom	Ceiling	Ceiling Tile 2' x 4'	Long Fissure Random Pinhole	NF	ACM	SL	S03abc	10-Mar-08	1.7% Amosite, 0.6% Chrysotile
518	Classroom	Piping	Pipe Fitting	Parged Cement	F	ACM	HM	1680.894.03	11-Sep-90	50-75% Chrysotile
518A	Instrument Room	Floor	Concrete	-	-	Non ACM	-	-	-	-
518A	Instrument Room	Wall	Concrete	-	-	Non ACM	-	-	-	-
518A	Instrument Room	Ceiling	Ceiling Tile 2' x 4'	Long Fissure Random Pinhole	NF	ACM	SL	S03abc	10-Mar-08	1.7% Amosite, 0.6% Chrysotile
518A	Instrument Room	Ceiling	Concrete	-	-	Non ACM	-	-	-	-
518B	Storage Room	Floor	Concrete	-	-	Non ACM	-	-	-	-
518B	Storage Room	Wall	Concrete	-	-	Non ACM	-	-	-	-
518B	Storage Room	Ceiling	Ceiling Tile 2' x 4'	Long Fissure Random Pinhole	NF	ACM	SL	S03abc	10-Mar-08	1.7% Amosite, 0.6% Chrysotile
518B	Storage Room	Ceiling	Concrete	-	-	Non ACM	-	-	-	-
518B	Storage Room	Piping	Pipe Fitting	Parged Cement	F	ACM	HM	1680.894.03	11-Sep-90	50-75% Chrysotile
518B	Storage Room	Piping	Pipe Insulation	Air Cell	F	ACM	HM	1680.894.04	11-Sep-90	>75% Amosite
518C	Fan Room	Floor	Concrete	-	-	Non ACM	-	-	-	-
518C	Fan Room	Wall	Concrete	-	-	Non ACM	-	-	-	-
518C	Fan Room	Ceiling	Concrete	-	-	Non ACM	-	-	-	-



<b>School Name</b> <b>Waterloo-Oxford District Secondary School</b> <b>Date Built:</b> Original: 1955 Addition(s): 1958, 1962, 1966, 1971, 1972, 2000, 2001, 2011	<b>Legend:</b> HM - Homogenous Material - homogeneous with previously sampled material SL - Sample Location - Material Sampled VC - Visually Confirmed - Material not sampled, deemed ACM NF - Non-Friable F- Friable	<b>Notes:</b> All quantities provided on Figures, if known. Refer to the Asbestos Audit Update Report for condition of ACM and recommended actions. Dates provided in Material Description/Room Description columns indicates date of installation/renovation and confirms the finishes as non-ACM.
---	--	---

WRDSB Fixed Reference Number	Room Description	Inspected Item	Inspected Material	Material Description	Friability	Asbestos Classification	Sample / Identification Summary	Sample ID	Sample Date	% Asbestos & Fibre Type
518C	Fan Room	Piping	Pipe Fitting	Parged Cement	F	ACM	HM	1680.894.03	11-Sep-90	50-75% Chrysotile
518C	Fan Room	Piping	Pipe Insulation	Air Cell	F	ACM	HM	1680.894.04	11-Sep-90	>75% Amosite
518C	Fan Room	Ducting	Flex Joint	-	NF	ACM	VC	-	-	-
801	Corridor - 1966	Floor	Terrazzo	-	-	Non ACM	-	-	-	-
801	Corridor - 1966	Wall	Plaster	-	-	Non ACM	SL	S72abc	13-Mar-08	ND
801	Corridor - 1966	Ceiling	Ceiling Tile 2' x 2'	Large and Small Pinhole (Drywall)	-	Non ACM	-	-	-	-
801	Corridor - 1966	Ceiling	Ceiling Tile 2' x 4'	Short Fissure Random Pinhole	-	Non ACM	HM	S01	10-May-18	ND
801	Corridor - 1966	Piping	Pipe Insulation	Fibreglass insulation	-	Non ACM	-	-	-	-
801	Corridor - 1966	Piping	Pipe Fitting	Parged Cement	F	ACM	SL	1680.894.03	11-Sep-90	50-75% Chrysotile
801	Corridor - 1966	Firespray	Firespray	Spray-applied	F	ACM	SL	S71abc	13-Mar-08	3.8% Chrysotile
802	Corridor - 1955	Floor	Terrazzo	-	-	Non ACM	-	-	-	-
802	Corridor - 1955	Wall	Plaster	-	-	Non ACM	HM	S64, S82	10-Mar-08	ND
802	Corridor - 1955	Ceiling	Ceiling Tile 2' x 4'	Short Fissure Random Pinhole (1991)	-	Non ACM	-	-	-	-
802	Corridor - 1955	Piping	Pipe Insulation	Fibreglass insulation	-	Non ACM	-	-	-	-
802	Corridor - 1955	Ceiling	Ceiling Tile 1' x 1'	Large and Small Pinhole	-	Non ACM	HM	S77	13-Mar-08	ND
802	Corridor - 1955	Wall	Drywall	Drywall Joint Compound	NF	ACM	HM	S81	10-Mar-08	1% Chrysotile
802	Corridor - 1955	Piping	Pipe Fitting	Parged Cement	F	ACM	HM	1680.894.03	11-Sep-90	50-75% Chrysotile
802	Corridor - 1955	Piping	Pipe Insulation	Air Cell	F	ACM	HM	1680.894.04	11-Sep-90	>75% Amosite
803	Corridor - 1955	Floor	Terrazzo	-	-	Non ACM	-	-	-	-
803	Corridor - 1955	Wall	Plaster	-	-	Non ACM	SL	S82b	13-Mar-08	ND
803	Corridor - 1955	Ceiling	Ceiling Tile 2' x 2'	Short Fissure Random Pinhole	-	Non ACM	SL	S92abc	13-Mar-08	ND
803	Corridor - 1955	Piping	Pipe Insulation	Air Cell	F	ACM	HM	1680.894.04	11-Sep-90	>75% Amosite
803	Corridor - 1955	Piping	Pipe Fitting	Parged Cement	F	ACM	HM	1680.894.03	11-Sep-90	50-75% Chrysotile
804	Corridor - 1955	Floor	Terrazzo	-	-	Non ACM	-	-	-	-
804	Corridor - 1955	Wall	Plaster	-	-	Non ACM	HM	S24, S72, S82	13-Mar-08	ND
804	Corridor - 1955	Ceiling	Ceiling Tile 2' x 4'	Short Fissure Random Pinhole (2004)	-	Non ACM	-	-	-	-
804	Corridor - 1955	Piping	Pipe Fitting	Parged Cement	F	ACM	HM	1680.894.03	11-Sep-90	50-75% Chrysotile
804A	Corridor - 1955	Floor	Terrazzo	-	-	Non ACM	-	-	-	-
804A	Corridor - 1955	Wall	Plaster	-	-	Non ACM	HM	S24, S72, S82	13-Mar-08	ND
804A	Corridor - 1955	Ceiling	Ceiling Tile 2' x 4'	Short Fissure Random Pinhole (2004)	-	Non ACM	-	-	-	-
805	Corridor - 1955	Floor	Vinyl Floor Tile 12"x 12"	Grey with Brown & White Fleck	-	Non ACM	HM	S37	13-Mar-08	ND
805	Corridor - 1955	Wall	Plaster	-	-	Non ACM	HM	S24, S72, S82	13-Mar-08	ND



<b>School Name</b> <b>Waterloo-Oxford District Secondary School</b> <b>Date Built:</b> Original: 1955 Addition(s): 1958, 1962, 1966, 1971, 1972, 2000, 2001, 2011	<b>Legend:</b> <b>HM</b> - Homogenous Material - homogeneous with previously sampled material <b>SL</b> - Sample Location - Material Sampled <b>VC</b> - Visually Confirmed - Material not sampled, deemed ACM <b>NF</b> - Non-Friable <b>F</b> - Friable	<b>Notes:</b> All quantities provided on Figures, if known. Refer to the Asbestos Audit Update Report for condition of ACM and recommended actions. Dates provided in Material Description/Room Description columns indicates date of installation/renovation and confirms the finishes as non-ACM.
---	--	---

WRDSB Fixed Reference Number	Room Description	Inspected Item	Inspected Material	Material Description	Friability	Asbestos Classification	Sample / Identification Summary	Sample ID	Sample Date	% Asbestos & Fibre Type
805	Corridor - 1955	Ceiling	Ceiling Tile 2' x 2'	Dense Fissure Small Pinhole	-	Non ACM	HM	S29	13-Mar-08	ND
805	Corridor - 1955	Piping	Pipe Insulation	Fibreglass insulation	-	Non ACM	-	-	-	-
807	Corridor - 1971	Floor	Terrazzo	-	-	Non ACM	-	-	-	-
807	Corridor - 1971	Wall	Plaster	-	-	Non ACM	SL	S35e	13-Mar-08	ND
807	Corridor - 1971	Ceiling	Ceiling Tile 2' x 2'	Large & Small Pinhole (Drywall)	-	Non ACM	-	-	-	-
807	Corridor - 1971	Ceiling	Ceiling Tile 2' x 2'	Dense Fissure Small Pinhole	-	Non ACM	SL	S29abc	13-Mar-08	ND
807	Corridor - 1971	Ducting	Duct Insulation	Fibreglass insulation	-	Non ACM	-	-	-	-
807	Corridor - 1971	Piping	Pipe Insulation	Fibreglass insulation	-	Non ACM	-	-	-	-
807A	Corridor	Floor	Vinyl Floor Tile 12"x 12"	Orange with White Fleck	NF	ACM	HM	S30	13-Mar-08	5.0% Chrysotile
807A	Corridor	Wall	Plaster	-	-	Non ACM	HM	S24, S72, S82	13-Mar-08	ND
807A	Corridor	Ceiling	Drywall	No Drywall Joint Compound	-	Non ACM	-	-	-	-
807A	Corridor	Ceiling	Ceiling Tile 2' x 2'	Dense Fissure Small Pinhole	-	Non ACM	HM	S29	13-Mar-08	ND
807A	Corridor	Piping	Pipe Insulation	Fibreglass insulation	-	Non ACM	-	-	-	-
807B	Stage Entrance/Hallway	Floor	Vinyl Floor Tile 9"x 9"	Orange with White Fleck	NF	ACM	HM	S30	13-Mar-08	5.0% Chrysotile
807B	Stage Entrance/Hallway	Wall	Concrete	-	-	Non ACM	-	-	-	-
807B	Stage Entrance/Hallway	Ceiling	Ceiling Tile 2 x 2	Large & Small Pinhole (Drywall)	-	Non ACM	-	-	-	-
807B	Stage Entrance/Hallway	Piping	Pipe Insulation	Fibreglass insulation	-	Non ACM	-	-	-	-
807C	Stage Entrance/Hallway	Floor	Vinyl Floor Tile 9"x 9"	Orange with White Fleck	NF	ACM	HM	S30	13-Mar-08	5.0% Chrysotile
807C	Stage Entrance/Hallway	Wall	Concrete	-	-	Non ACM	-	-	-	-
807C	Stage Entrance/Hallway	Ceiling	Ceiling Tile 2 x 2	Large & Small Pinhole (Drywall)	-	Non ACM	-	-	-	-
807C	Stage Entrance/Hallway	Piping	Pipe Insulation	Fibreglass insulation	-	Non ACM	-	-	-	-
808	Corridor - 1955	Floor	Terrazzo	-	-	Non ACM	-	-	-	-
808	Corridor - 1955	Wall	Plaster	-	-	Non ACM	HM	S82	13-Mar-08	ND
808	Corridor - 1955	Ceiling	Ceiling Tile 2' x 2'	Short Fissure Random Pinhole	-	Non ACM	HM	S01	10-May-18	ND
808	Corridor - 1955	Piping	Pipe Fitting	Parged Cement	F	ACM	HM	1680.894.03	11-Sep-90	50-75% Chrysotile
809	Corridor - 1962	Floor	Vinyl Floor Tile 12"x 12"	Green with Grey and White	-	Non ACM	SL	S67abc	-	-
809	Corridor - 1962	Floor	Vinyl Floor Tile 12"x 12"	Black with Grey and White	-	Non ACM	SL	S66abc	-	-
809	Corridor - 1962	Floor	Vinyl Floor Tile 12"x 12"	Brown with Brown and White Fleck	-	Non ACM	HM	S53	13-Mar-08	ND
809	Corridor - 1962	Wall	Plaster	-	-	Non ACM	SL	S64de	10-Mar-08	ND
809	Corridor - 1962	Ceiling	Ceiling Tile 2' x 2'	Short Fissure Random Pinhole (Post 2021)	-	Non ACM	-	-	-	-
809	Corridor - 1962	Piping	Pipe Fitting	Parged Cement	F	ACM	HM	1680.894.03	11-Sep-90	50-75% Chrysotile
810	Corridor - 1958	Floor	Terrazzo	-	-	Non ACM	-	-	-	-

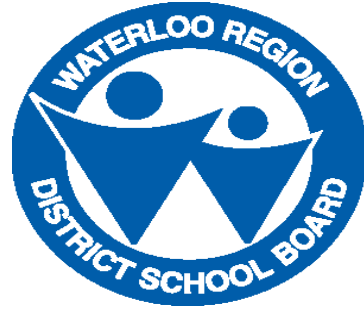

<b>School Name</b> <b>Waterloo-Oxford District Secondary School</b> <b>Date Built:</b> Original: 1955 Addition(s): 1958, 1962, 1966, 1971, 1972, 2000, 2001, 2011	<b>Legend:</b> HM - Homogenous Material - homogeneous with previously sampled material SL - Sample Location - Material Sampled VC - Visually Confirmed - Material not sampled, deemed ACM NF - Non-Friable F- Friable	<b>Notes:</b> All quantities provided on Figures, if known. Refer to the Asbestos Audit Update Report for condition of ACM and recommended actions. Dates provided in Material Description/Room Description columns indicates date of installation/renovation and confirms the finishes as non-ACM.
---	--	---

WRDSB Fixed Reference Number	Room Description	Inspected Item	Inspected Material	Material Description	Friability	Asbestos Classification	Sample / Identification Summary	Sample ID	Sample Date	% Asbestos & Fibre Type
810	Corridor - 1958	Wall	Plaster	-	-	Non ACM	SL	S27abcd	13-Mar-08	ND
810	Corridor - 1958	Ceiling	Ceiling Tile 2 x 2	Large & Small Pinhole (Drywall)	-	Non ACM	-	-	-	-
810	Corridor - 1958	Ceiling	Ceiling Tile 2' x 2'	Short Fissure Random Pinhole (Post 1994)	-	Non ACM	-	-	-	-
810	Corridor - 1958	Piping	Pipe Insulation	Fibreglass insulation	-	Non ACM	-	-	-	-
810	Corridor - 1958	Firespray	Firespray	Troweled-applied	F	ACM	HM	S23	13-Mar-08	3.2% Chrysotile
811	Corridor - 1966	Floor	Terrazzo	-	-	Non ACM	-	-	-	-
811	Corridor - 1966	Floor	Concrete	-	-	Non ACM	-	-	-	-
811	Corridor - 1966	Wall	Plaster	-	-	Non ACM	SL	S24e	13-Mar-08	ND
811	Corridor - 1966	Ceiling	Ceiling Tile 2 x 2	Large & Small Pinhole (Drywall)	-	Non ACM	-	-	-	-
811	Corridor - 1966	Ceiling	Ceiling Tile 2' x 2'	Short Fissure Random Pinhole (Post 1994)	-	Non ACM	-	-	-	-
811	Corridor - 1966	Firespray	Firespray	Troweled-applied	F	ACM	HM	S23	13-Mar-08	3.2% Chrysotile
812	Corridor - 1962	Floor	Terrazzo	-	-	Non ACM	-	-	-	-
812	Corridor - 1962	Wall	Plaster	-	-	Non ACM	HM	S24	13-Mar-08	ND
812	Corridor - 1962	Ceiling	Ceiling Tile 2 x 2	Large & Small Pinhole	NF	ACM	-	-	-	-
812	Corridor - 1962	Ceiling	Ceiling Tile 2' x 2'	Short Fissure Random Pinhole (Post 1994)	-	Non ACM	-	-	-	-
812	Corridor - 1962	Piping	Pipe Fitting	Parged Cement	F	ACM	HM	1680.894.03	11-Sep-90	50-75% Chrysotile
812	Corridor - 1962	Firespray	Firespray	-	F	ACM	HM	S23	13-Mar-08	3.2% Chrysotile
813	Corridor - 1972	Floor	Terrazzo	-	-	Non ACM	-	-	-	-
813	Corridor - 1972	Wall	Plaster	-	-	Non ACM	SL	S02cde	-	ND
813	Corridor - 1972	Ceiling	Ceiling Tile 2' x 2'	Large Pinhole (Drywall)	-	Non ACM	-	-	-	-
813	Corridor - 1972	Ceiling	Ceiling Tile 2' x 2'	Short Fissure Random Pinhole (2013)	-	Non ACM	-	-	-	-
813	Corridor - 1972	Piping	Pipe Insulation	Fiberglass insulation	-	Non ACM	-	-	-	-
813	Corridor - 1972	Firespray	Firespray	Spray-applied	F	ACM	HM	S06	10-Mar-08	4.1% Chrysotile
813	Corridor - 1966	Floor	Terrazzo	-	-	Non ACM	-	-	-	-
813	Corridor - 1966	Wall	Plaster	-	-	Non ACM	SL	S05abcd	10-Mar-08	ND
813	Corridor - 1966	Ceiling	Ceiling Tile 2' x 2'	Large Pinhole (Drywall)	-	Non ACM	-	-	-	-
813	Corridor - 1966	Ceiling	Drywall	No Drywall Joint Compound	-	Non ACM	-	-	-	-
813	Corridor - 1966	Firespray	Firespray	-	F	ACM	SL	S06abc	10-Mar-08	4.1% Chrysotile
813	Corridor - 1966	Piping	Pipe Fitting	Parged Cement	F	ACM	HM	1680.894.03	11-Sep-90	50-75% Chrysotile
813	Corridor - 1962	Floor	Terrazzo	-	-	Non ACM	-	-	-	-
813	Corridor - 1962	Wall	Plaster	-	-	Non ACM	SL	S19abcde	10-Mar-08	ND
813	Corridor - 1962	Ceiling	Ceiling Tile 2' x 2'	Large Pinhole (Drywall)	-	Non ACM	-	-	-	-





<b>School Name</b> <b>Waterloo-Oxford District Secondary School</b> <b>Date Built:</b> Original: 1955 Addition(s): 1958, 1962, 1966, 1971, 1972, 2000, 2001, 2011	<b>Legend:</b> HM - Homogenous Material - homogeneous with previously sampled material SL - Sample Location - Material Sampled VC - Visually Confirmed - Material not sampled, deemed ACM NF - Non-Friable F- Friable	<b>Notes:</b> All quantities provided on Figures, if known. Refer to the Asbestos Audit Update Report for condition of ACM and recommended actions. Dates provided in Material Description/Room Description columns indicates date of installation/renovation and confirms the finishes as non-ACM.
---	--	---

WRDSB Fixed Reference Number	Room Description	Inspected Item	Inspected Material	Material Description	Friability	Asbestos Classification	Sample / Identification Summary	Sample ID	Sample Date	% Asbestos & Fibre Type
813	Corridor - 1962	Ceiling	Drywall	No Drywall Joint Compound	-	Non ACM	-	-	-	-
813	Corridor - 1962	Firespray	Firespray	-	F	ACM	SL	S06abc	10-Mar-08	4.1% Chrysotile
813	Corridor - 1962	Piping	Pipe Fitting	Parged Cement	F	ACM	HM	1680.894.03	11-Sep-90	50-75% Chrysotile
814	Corridor	Floor	Terrazzo	-	-	Non ACM	-	-	-	-
814	Corridor	Wall	Concrete	-	-	Non ACM	-	-	-	-
814	Corridor	Wall	Ceramic Tile	-	-	Non ACM	-	-	-	-
814	Corridor	Ceiling	Ceiling Tile 1' x 1'	Large and Small	-	Non ACM	HM	S10	10-Mar-08	ND
814	Corridor	Ceiling	Ceiling Tile 2' x 4'	Short Fissure Random Pinhole	-	Non ACM	HM	S01	10-May-18	ND
815	Corridor	Floor	Vinyl Floor Tile 9"x 9"	Tan with White & Black Fleck	NF	ACM	HM	S26	13-Mar-08	0.75% Chrysotile
815	Corridor	Wall	Plaster	-	-	Non ACM	HM	S24, S72, S82	13-Mar-08	ND
815	Corridor	Wall	Concrete	-	-	Non ACM	-	-	-	-
815	Corridor	Ceiling	Ceiling Tile 1' x 1'	Medium and Small Pinhole	NF	ACM	HM	S12	10-Mar-08	2.1% Amosite
816	Corridor	Floor	Vinyl Floor Tile 12"x 12"	White with Grey Fleck (Post 2010)	-	Non ACM	-	-	-	-
816	Corridor	Wall	Concrete	-	-	Non ACM	-	-	-	-
816	Corridor	Wall	Plaster	-	-	Non ACM	HM	S24, S72, S82	13-Mar-08	ND
816	Corridor	Ceiling	Ceiling Tile 2' x 4'	Short Fissure Random Pinhole	-	Non ACM	HM	S01	10-May-18	ND
818	Corridor	Floor	Vinyl Floor Tile 12"x 12"	Orange with White Fleck	NF	ACM	HM	S30	13-Mar-08	5.0% Chrysotile
818	Corridor	Wall	Concrete	-	-	Non ACM	-	-	-	-
818	Corridor	Ceiling	Plaster	-	-	Non ACM	HM	S24, S72, S82	13-Mar-08	ND
818	Corridor	Piping	Pipe Insulation	Fibreglass insulation	-	Non ACM	-	-	-	-
818	Corridor	Above Ceiling	Texture Coat	-	F	ACM	HM	S39	13-Mar-08	20% Chrysotile
819	Corridor	Floor	Vinyl Floor Tile 12"x 12"	Grey with Brown & White Fleck	-	Non ACM	HM	S37	13-Mar-08	ND
819	Corridor	Wall	Concrete	-	-	Non ACM	-	-	-	-
819	Corridor	Ceiling	Ceiling Tile 2' x 2'	Solid Pattern	-	Non ACM	HM	S38	13-Mar-08	ND
819	Corridor	Piping	Pipe Insulation	Fibreglass insulation	-	Non ACM	-	-	-	-
820	Corridor	Floor	Concrete	-	-	Non ACM	-	-	-	-
820	Corridor	Wall	Concrete	-	-	Non ACM	-	-	-	-
820	Corridor	Wall	Brick	-	-	Non ACM	-	-	-	-
820	Corridor	Deck	Concrete	-	-	Non ACM	-	-	-	-
820	Corridor	Piping	Pipe Fitting	Parged Cement	F	ACM	HM	1680.894.03	11-Sep-90	50-75% Chrysotile
830	Corridor	Floor	Vinyl Floor Tile 12"x 12"	Grey Oatmeal	-	Non ACM	HM	S90	13-Mar-08	ND
830	Corridor	Wall	Plaster	-	-	Non ACM	HM	S64, S82	10-Mar-08	ND



<b>School Name</b> <b>Waterloo-Oxford District Secondary School</b> <b>Date Built:</b> Original: 1955 Addition(s): 1958, 1962, 1966, 1971, 1972, 2000, 2001, 2011	<b>Legend:</b> HM - Homogenous Material - homogeneous with previously sampled material SL - Sample Location - Material Sampled VC - Visually Confirmed - Material not sampled, deemed ACM NF - Non-Friable F- Friable	<b>Notes:</b> All quantities provided on Figures, if known. Refer to the Asbestos Audit Update Report for condition of ACM and recommended actions. Dates provided in Material Description/Room Description columns indicates date of installation/renovation and confirms the finishes as non-ACM.
---	--	---

WRDSB Fixed Reference Number	Room Description	Inspected Item	Inspected Material	Material Description	Friability	Asbestos Classification	Sample / Identification Summary	Sample ID	Sample Date	% Asbestos & Fibre Type
830	Corridor	Wall	Drywall	Drywall Joint Compound	NF	ACM	HM	S81	10-Mar-08	1% Chrysotile
830	Corridor	Ceiling	Ceiling Tile 2' x 4'	Short Fissure Random Pinhole (1997)	-	Non ACM	-	-	-	-
830	Corridor	Piping	Pipe Insulation	Fibreglass insulation	-	Non ACM	-	-	-	-
901	Stairwell	Floor	Terrazzo	-	-	Non ACM	-	-	-	-
901	Stairwell	Wall	Plaster	-	-	Non ACM	HM	S72, S82	13-Mar-08	ND
901	Stairwell	Ceiling	Ceiling Tile 2' x 4'	Random Fissure Random Pinhole (2021)	-	Non ACM	-	-	-	-
901	Stairwell	Ceiling	Drywall	Drywall Joint Compound	NF	ACM	HM	S81	10-Mar-08	1% Chrysotile
902	Stairwell	Floor	Terrazzo	-	-	Non ACM	-	-	-	-
902	Stairwell	Wall	Plaster	-	-	Non ACM	HM	S72, S82	13-Mar-08	ND
902	Stairwell	Ceiling	Ceiling Tile 2' x 4'	Random Fissure Random Pinhole (2021)	-	Non ACM	-	-	-	-
902	Stairwell	Ceiling	Drywall	Drywall Joint Compound	NF	ACM	HM	S81	10-Mar-08	1% Chrysotile
903	Stairwell	Floor	Terrazzo	-	-	Non ACM	-	-	-	-
903	Stairwell	Wall	Concrete	-	-	Non ACM	-	-	-	-
903	Stairwell	Wall	Plaster	-	-	Non ACM	HM	S82	13-Mar-08	ND
903	Stairwell	Ceiling	Plaster	-	-	Non ACM	HM	S82	13-Mar-08	ND
904	Stairwell	Floor	Terrazzo	-	-	Non ACM	-	-	-	-
904	Stairwell	Wall	Concrete	-	-	Non ACM	-	-	-	-
904	Stairwell	Wall	Plaster	-	-	Non ACM	HM	S82	13-Mar-08	ND
904	Stairwell	Ceiling	Plaster	-	-	Non ACM	HM	S82	13-Mar-08	ND
905	Stairwell	Floor	Terrazzo	-	-	Non ACM	-	-	-	-
905	Stairwell	Wall	Plaster	-	-	Non ACM	HM	S27	10-Mar-08	ND
905	Stairwell	Ceiling	Ceiling Tile 1' x 1'	Large and Small Pinhole	-	Non ACM	HM	S77	10-May-18	ND
905	Stairwell	Floor	Terrazzo	-	-	Non ACM	-	-	-	-
905	Stairwell	Wall	Plaster	-	-	Non ACM	HM	S27	10-Mar-08	ND
905	Stairwell	Ceiling	Ceiling Tile 1' x 1'	Large and Small Pinhole	-	Non ACM	HM	S77	10-May-18	ND
905	Stairwell	Floor	Terrazzo	-	-	Non ACM	-	-	-	-
905	Stairwell	Wall	Plaster	-	-	Non ACM	SL	S35abcd	13-Mar-08	ND
905	Stairwell	Ceiling	Ceiling Tile 2' x 2'	Dense Fissure Small Pinhole	-	Non ACM	SL	S29abc	13-Mar-08	ND
905	Stairwell	Ceiling	Ceiling Tile 2' x 4'	Short Fissure Random Pinhole (Post 1994)	-	Non ACM	-	-	-	-
905A	Stairwell	Floor	Terrazzo	-	-	Non ACM	-	-	-	-
905A	Stairwell	Wall	Concrete	-	-	Non ACM	-	-	-	-
905A	Stairwell	Wall	Plaster	-	-	Non ACM	HM	S24, S72, S82	13-Mar-08	ND



<b>School Name</b> <b>Waterloo-Oxford District Secondary School</b> <b>Date Built:</b> Original: 1955 Addition(s): 1958, 1962, 1966, 1971, 1972, 2000, 2001, 2011	<b>Legend:</b> HM - Homogenous Material - homogeneous with previously sampled material SL - Sample Location - Material Sampled VC - Visually Confirmed - Material not sampled, deemed ACM NF - Non-Friable F- Friable	<b>Notes:</b> All quantities provided on Figures, if known. Refer to the Asbestos Audit Update Report for condition of ACM and recommended actions. Dates provided in Material Description/Room Description columns indicates date of installation/renovation and confirms the finishes as non-ACM.
---	--	---

WRDSB Fixed Reference Number	Room Description	Inspected Item	Inspected Material	Material Description	Friability	Asbestos Classification	Sample / Identification Summary	Sample ID	Sample Date	% Asbestos & Fibre Type
905A	Stairwell	Ceiling	Plaster	-	-	Non ACM	HM	S24, S72, S82	13-Mar-08	ND
905A	Stairwell	Piping	Pipe Insulation	Fibreglass insulation	-	Non ACM	-	-	-	-
905A	Stairwell	Piping	Pipe Fitting	Fibreglass/PVC	-	Non ACM	-	-	-	-
906	Stairwell	Floor	Vinyl Floor Tile 12"x 12"	Orange with White Fleck	NF	ACM	SL	S30abc	13-Mar-08	5.0% Chrysotile
906	Stairwell	Floor	Vinyl Floor Tile 12"x 12"	Beige with Grey Fleck	NF	ACM	SL	S31abc	13-Mar-08	5.0% Chrysotile
906	Stairwell	Wall	Concrete	-	-	Non ACM	-	-	-	-
906	Stairwell	Ceiling	Ceiling Tile 2' x 2'	Dense Fissure Small Pinhole	-	Non ACM	SL	S29abc	13-Mar-08	ND
906	Stairwell	Piping	Pipe Insulation	Fibreglass insulation	-	Non ACM	-	-	-	-
907	Stairwell	Floor	Concrete	-	-	Non ACM	-	-	-	-
907	Stairwell	Wall	Concrete	-	-	Non ACM	-	-	-	-
907	Stairwell	Ceiling	Concrete	-	-	Non ACM	-	-	-	-
908	Stairwell	Floor	Terrazzo	-	-	Non ACM	-	-	-	-
908	Stairwell	Wall	Plaster	-	-	Non ACM	HM	S24, S43	10-Mar-08	ND
908	Stairwell	Wall	Concrete	-	-	Non ACM	-	-	-	-
908	Stairwell	Ceiling	Ceiling Tile 1' x 1'	Large and Small Pinhole	-	Non ACM	SL	S04abc	10-Mar-08	ND
908	Stairwell	Ceiling	Plaster	-	-	Non ACM	HM	S24, S43	10-Mar-08	ND
908A	Stairwell	Floor	Terrazzo	-	-	Non ACM	-	-	-	-
908A	Stairwell	Wall	Plaster	-	-	Non ACM	HM	S24, S43	10-Mar-08	ND
908A	Stairwell	Wall	Concrete	-	-	Non ACM	-	-	-	-
908A	Stairwell	Ceiling	Plaster	-	-	Non ACM	HM	S24, S43	10-Mar-08	ND
909	Stairwell	Floor	Terrazzo	-	-	Non ACM	-	-	-	-
909	Stairwell	Wall	Plaster	-	-	Non ACM	HM	S02	10-Mar-08	ND
909	Stairwell	Wall	Concrete	-	-	Non ACM	-	-	-	-
909	Stairwell	Ceiling	Plaster	-	-	Non ACM	HM	S02	10-Mar-08	ND
909	Stairwell	Ceiling	Ceiling Tile 2' x 2'	Large Pinhole (Drywall)	-	Non ACM	-	-	-	-
909	Stairwell	Floor	Terrazzo	-	-	Non ACM	-	-	-	-
909	Stairwell	Wall	Plaster	-	-	Non ACM	HM	S35	-	-
909	Stairwell	Ceiling	Ceiling Tile 2' x 2'	Short Fissure Random Pinhole	-	Non ACM	HM	S01	10-May-18	ND
<b>Level 2</b>										
118	Washroom	Floor	Terrazzo	-	-	Non ACM	-	-	-	-

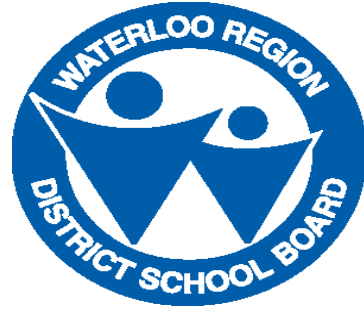

<b>School Name</b> <b>Waterloo-Oxford District Secondary School</b> <b>Date Built:</b> Original: 1955 Addition(s): 1958, 1962, 1966, 1971, 1972, 2000, 2001, 2011	<b>Legend:</b> HM - Homogenous Material - homogeneous with previously sampled material SL - Sample Location - Material Sampled VC - Visually Confirmed - Material not sampled, deemed ACM NF - Non-Friable F- Friable	<b>Notes:</b> All quantities provided on Figures, if known. Refer to the Asbestos Audit Update Report for condition of ACM and recommended actions. Dates provided in Material Description/Room Description columns indicates date of installation/renovation and confirms the finishes as non-ACM.
---	--	---

WRDSB Fixed Reference Number	Room Description	Inspected Item	Inspected Material	Material Description	Friability	Asbestos Classification	Sample / Identification Summary	Sample ID	Sample Date	% Asbestos & Fibre Type
118	Washroom	Wall	Concrete	-	-	Non ACM	-	-	-	-
118	Washroom	Ceiling	Plaster	-	-	Non ACM	HM	S72	13-Mar-08	ND
118A	Custodial Room	Floor	Terrazzo	-	-	Non ACM	-	-	-	-
118A	Custodial Room	Wall	Concrete	-	-	Non ACM	-	-	-	-
118A	Custodial Room	Ceiling	Plaster	-	-	Non ACM	HM	S72	13-Mar-08	ND
120	Washroom	Floor	Terrazzo	-	-	Non ACM	-	-	-	-
120	Washroom	Wall	Concrete	-	-	Non ACM	-	-	-	-
120	Washroom	Ceiling	Plaster	-	-	Non ACM	HM	S72	13-Mar-08	ND
120A	Fan Room	Floor	Concrete	-	-	Non ACM	-	-	-	-
120A	Fan Room	Wall	Concrete	-	-	Non ACM	-	-	-	-
120A	Fan Room	Deck	Concrete	-	-	Non ACM	-	-	-	-
120A	Fan Room	Fireproofing	Fireproofing	Troweled-Applied	F	ACM	SL	S01abc	3-Oct-22	40% Chrysotile
120A	Fan Room	Piping	Pipe Fitting	Parged Cement	F	ACM	HM	1680.894.03	11-Sep-90	50-75% Chrysotile
120A	Fan Room	Ducting	Flex Joint	-	NF	ACM	VC	-	-	-
120A	Fan Room	Piping	Pipe Insulation	Fibreglass insulation	-	Non ACM	-	-	-	-
121	Classroom	Floor	Vinyl Floor Tile 12"x 12"	Beige Dense Fleck (Post 2013)	-	Non ACM	-	-	-	-
121	Classroom	Wall	Concrete	-	-	Non ACM	-	-	-	-
121	Classroom	Wall	Plaster	-	-	Non ACM	HM	S72	13-Mar-08	ND
121	Classroom	Ceiling	Ceiling Tile 2' x 4'	Random Fissure Random Pinhole (2021)	-	Non ACM	-	-	-	-
121	Classroom	Firespray	Firespray	Colour Sprayed Applied (2021)	-	Non ACM	-	-	-	-
122	Classroom	Floor	Vinyl Sheet Flooring	New (2021)	-	Non ACM	-	-	-	-
122	Classroom	Wall	Concrete	-	-	Non ACM	-	-	-	-
122	Classroom	Wall	Plaster	-	-	Non ACM	HM	S72, S82	13-Mar-08	ND
122	Classroom	Ceiling	Ceiling Tile 2' x 4'	Random Fissure Random Pinhole (2021)	-	Non ACM	-	-	-	-
122	Classroom	Firespray	Firespray	Colour Sprayed Applied (2021)	-	Non ACM	-	-	-	-
123	Classroom	Floor	Vinyl Floor Tile 9"x 9"	Olive with Black Streak	NF	ACM	SL	S11ABC	10-May-18	1% Chrysotile
123	Classroom	Wall	Concrete	-	-	Non ACM	-	-	-	-
123	Classroom	Wall	Plaster	-	-	Non ACM	HM	S72, S82	13-Mar-08	ND
123	Classroom	Ceiling	Ceiling Tile 2' x 4'	Random Fissure Random Pinhole (2021)	-	Non ACM	-	-	-	-
123	Classroom	Firespray	Firespray	Colour Sprayed Applied (2021)	-	Non ACM	-	-	-	-
124	Classroom	Floor	Vinyl Sheet Flooring	New (2021)	-	Non ACM	-	-	-	-
124	Classroom	Wall	Concrete	-	-	Non ACM	-	-	-	-



<b>School Name</b> <b>Waterloo-Oxford District Secondary School</b> <b>Date Built:</b> Original: 1955 Addition(s): 1958, 1962, 1966, 1971, 1972, 2000, 2001, 2011	<b>Legend:</b> HM - Homogenous Material - homogeneous with previously sampled material SL - Sample Location - Material Sampled VC - Visually Confirmed - Material not sampled, deemed ACM NF - Non-Friable F- Friable	<b>Notes:</b> All quantities provided on Figures, if known. Refer to the Asbestos Audit Update Report for condition of ACM and recommended actions. Dates provided in Material Description/Room Description columns indicates date of installation/renovation and confirms the finishes as non-ACM.
---	--	---

WRDSB Fixed Reference Number	Room Description	Inspected Item	Inspected Material	Material Description	Friability	Asbestos Classification	Sample / Identification Summary	Sample ID	Sample Date	% Asbestos & Fibre Type
124	Classroom	Wall	Plaster	-	-	Non ACM	HM	S72, S82	13-Mar-08	ND
124	Classroom	Ceiling	Ceiling Tile 2' x 4'	Random Fissure Random Pinhole (2021)	-	Non ACM	-	-	-	-
124	Classroom	Firespray	Firespray	Colour Sprayed Applied (2021)	-	Non ACM	-	-	-	-
125	Classroom	Floor	Vinyl Floor Tile 9"x 9"	Green with Faded Streak	NF	ACM	SL	S76abc	13-Mar-08	1.4% Chrysotile
125	Classroom	Wall	Concrete	-	-	Non ACM	-	-	-	-
125	Classroom	Wall	Plaster	-	-	Non ACM	SL	S72de	13-Mar-08	ND
125	Classroom	Ceiling	Ceiling Tile 2' x 4'	Random Fissure Random Pinhole (2021)	-	Non ACM	-	-	-	-
125	Classroom	Firespray	Firespray	Colour Sprayed Applied (2021)	-	Non ACM	-	-	-	-
126	Classroom	Floor	Vinyl Sheet Flooring	New (2021)	-	Non ACM	-	-	-	-
126	Classroom	Wall	Concrete	-	-	Non ACM	-	-	-	-
126	Classroom	Wall	Plaster	-	-	Non ACM	HM	S72, S82	13-Mar-08	ND
126	Classroom	Ceiling	Ceiling Tile 2' x 4'	Random Fissure Random Pinhole (2021)	-	Non ACM	-	-	-	-
126	Classroom	Firespray	Firespray	Colour Sprayed Applied (2021)	-	Non ACM	-	-	-	-
127	Classroom	Floor	Vinyl Floor Tile 9"x 9"	Beige with Brown & White Fleck	NF	ACM	SL	S75abc	13-Mar-08	1.5% Chrysotile
127	Classroom	Wall	Concrete	-	-	Non ACM	-	-	-	-
127	Classroom	Wall	Plaster	-	-	Non ACM	HM	S72, S82	13-Mar-08	ND
127	Classroom	Ceiling	Ceiling Tile 2' x 4'	Random Fissure Random Pinhole (2021)	-	Non ACM	-	-	-	-
127	Classroom	Firespray	Firespray	Colour Sprayed Applied (2021)	-	Non ACM	-	-	-	-
128	Classroom	Floor	Vinyl Sheet Flooring	New (2021)	-	Non ACM	-	-	-	-
128	Classroom	Wall	Concrete	-	-	Non ACM	-	-	-	-
128	Classroom	Wall	Plaster	-	-	Non ACM	HM	S72, S82	13-Mar-08	ND
128	Classroom	Ceiling	Ceiling Tile 2' x 4'	Random Fissure Random Pinhole (2021)	-	Non ACM	-	-	-	-
128	Classroom	Firespray	Firespray	Colour Sprayed Applied (2021)	-	Non ACM	-	-	-	-
520	Washroom	Floor	Vinyl Floor Tile 12"x 12"	Beige with Beige Fleck	-	Non ACM	SL	S57abc	10-Mar-08	ND
520	Washroom	Wall	Plaster	-	-	Non ACM	HM	S27	10-Mar-08	ND
520	Washroom	Ceiling	Plaster	-	-	Non ACM	HM	S27	10-Mar-08	ND
520A	Custodial Closet	Floor	Vinyl Floor Tile 12"x 12"	Grey with Grey and White Spots	-	Non ACM	SL	S58abc	10-Mar-08	ND
520A	Custodial Closet	Wall	Plaster	-	-	Non ACM	HM	S27	10-Mar-08	ND
520A	Custodial Closet	Wall	Wood	-	-	Non ACM	-	-	-	-
520A	Custodial Closet	Ceiling	Plaster	-	-	Non ACM	HM	S27	10-Mar-08	ND
521	Computer Room	Floor	Vinyl Floor Tile 9"x 9"	Green with White Streaks	NF	ACM	SL	S21abc	10-Mar-08	0.5% Chrysotile
521	Computer Room	Wall	Plaster	-	-	Non ACM	HM	S27	10-Mar-08	ND



<b>School Name</b> <b>Waterloo-Oxford District Secondary School</b> <b>Date Built:</b> Original: 1955 Addition(s): 1958, 1962, 1966, 1971, 1972, 2000, 2001, 2011	<b>Legend:</b> HM - Homogenous Material - homogeneous with previously sampled material SL - Sample Location - Material Sampled VC - Visually Confirmed - Material not sampled, deemed ACM NF - Non-Friable F- Friable	<b>Notes:</b> All quantities provided on Figures, if known. Refer to the Asbestos Audit Update Report for condition of ACM and recommended actions. Dates provided in Material Description/Room Description columns indicates date of installation/renovation and confirms the finishes as non-ACM.
---	--	---

WRDSB Fixed Reference Number	Room Description	Inspected Item	Inspected Material	Material Description	Friability	Asbestos Classification	Sample / Identification Summary	Sample ID	Sample Date	% Asbestos & Fibre Type
521	Computer Room	Ceiling	Ceiling Tile 2' x 4'	Short Fissure Random Pinhole	-	Non ACM	HM	S01	10-May-18	ND
521	Computer Room	Ceiling	Ceiling Tile 1' x 1'	Medium and Small Hole (Cellulose)	-	Non ACM	-	-	-	-
521A	Office	Floor	Vinyl Floor Tile 9"x 9"	Green with White Streaks	NF	ACM	HM	S21	10-Mar-08	0.5% Chrysotile
521A	Office	Wall	Plaster	-	-	Non ACM	HM	S27	10-Mar-08	ND
521A	Office	Ceiling	Ceiling Tile 2' x 4'	Short Fissure Random Pinhole	-	Non ACM	HM	S01	10-May-18	ND
521A	Office	Ceiling	Ceiling Tile 1' x 1'	Large/Medium Pinhole	-	Non ACM	HM	S13	10-May-18	ND
522	Classroom	Floor	Vinyl Floor Tile 9"x 9"	Blue with White Fleck	NF	ACM	HM	S20	10-Mar-08	0.5% Chrysotile
522	Classroom	Wall	Plaster	-	-	Non ACM	HM	S27	10-Mar-08	ND
522	Classroom	Ceiling	Ceiling Tile 2' x 4'	Short Fissure Random Pinhole	-	Non ACM	HM	S01	10-May-18	ND
522	Classroom	Ceiling	Ceiling Tile 1' x 1'	Medium and Small Hole (Cellulose)	-	Non ACM	-	-	-	-
523	Computer Room	Floor	Vinyl Floor Tile 9"x 9"	Green with White Streaks	NF	ACM	HM	S21	10-Mar-08	0.5% Chrysotile
523	Computer Room	Wall	Plaster	-	-	Non ACM	HM	S27	10-Mar-08	ND
523	Computer Room	Ceiling	Ceiling Tile 2' x 4'	Short Fissure Random Pinhole	-	Non ACM	HM	S01	10-May-18	ND
523	Computer Room	Ceiling	Ceiling Tile 1' x 1'	Medium and Small Hole (Cellulose)	-	Non ACM	-	-	-	-
524	Classroom	Floor	Vinyl Floor Tile 9"x 9"	Olive/Green/Grey with White Streaks	NF	ACM	SL	S56abc	10-Mar-08	-
524	Classroom	Wall	Plaster	-	-	Non ACM	HM	S27	10-Mar-08	ND
524	Classroom	Ceiling	Ceiling Tile 2' x 4'	Short Fissure Random Pinhole	-	Non ACM	HM	S01	10-May-18	ND
524	Classroom	Ceiling	Ceiling Tile 1' x 1'	Medium and Small Hole (Cellulose)	-	Non ACM	-	-	-	-
525	Classroom	Floor	Vinyl Floor Tile 9"x 9"	Blue with White Streaks	NF	ACM	HM	S20	10-Mar-08	0.5% Chrysotile
525	Classroom	Wall	Plaster	-	-	Non ACM	HM	S19	10-Mar-08	ND
525	Classroom	Ceiling	Ceiling Tile 2' x 4'	Short Fissure Random Pinhole	-	Non ACM	HM	S01	10-May-18	ND
525	Classroom	Ceiling	Ceiling Tile 1' x 1'	Medium and Small Hole (Cellulose)	-	Non ACM	-	-	-	-
526	Classroom	Floor	Vinyl Floor Tile 9"x 9"	Red/Brown with White and Brown Streaks	NF	ACM	SL	S55abc	10-Mar-08	1.4% Chrysotile
526	Classroom	Wall	Plaster	-	-	Non ACM	HM	S27	10-Mar-08	ND
526	Classroom	Ceiling	Ceiling Tile 2' x 4'	Short Fissure Random Pinhole	-	Non ACM	HM	S01	10-May-18	ND
526	Classroom	Ceiling	Ceiling Tile 1' x 1'	Medium and Small Hole (Cellulose)	-	Non ACM	-	-	-	-
527	Classroom	Floor	Vinyl Floor Tile 9"x 9"	Dark Grey/Brown with Brown and White	NF	ACM	SL	S52abc	10-Mar-08	1.2% Chrysotile
527	Classroom	Wall	Plaster	-	-	Non ACM	HM	S19	10-Mar-08	ND
527	Classroom	Ceiling	Ceiling Tile 2' x 4'	Short Fissure Random Pinhole	-	Non ACM	HM	S01	10-May-18	ND
527	Classroom	Ceiling	Ceiling Tile 1' x 1'	Medium and Small Hole (Cellulose)	-	Non ACM	-	-	-	-
528	Classroom	Floor	Vinyl Floor Tile 9"x 9"	Green with White Streaks	NF	ACM	SL	S21abc	10-Mar-08	0.5% Chrysotile
528	Classroom	Wall	Plaster	-	-	Non ACM	HM	S19	10-Mar-08	ND

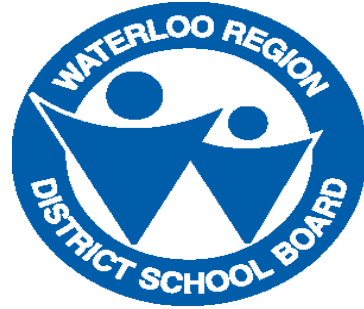

<b>School Name</b> <b>Waterloo-Oxford District Secondary School</b> <b>Date Built:</b> Original: 1955 Addition(s): 1958, 1962, 1966, 1971, 1972, 2000, 2001, 2011	<b>Legend:</b> <b>HM</b> - Homogenous Material - homogeneous with previously sampled material <b>SL</b> - Sample Location - Material Sampled <b>VC</b> - Visually Confirmed - Material not sampled, deemed ACM <b>NF</b> - Non-Friable <b>F</b> - Friable	<b>Notes:</b> All quantities provided on Figures, if known. Refer to the Asbestos Audit Update Report for condition of ACM and recommended actions.  Dates provided in Material Description/Room Description columns indicates date of installation/renovation and confirms the finishes as non-ACM.
---	--	---

WRDSB Fixed Reference Number	Room Description	Inspected Item	Inspected Material	Material Description	Friability	Asbestos Classification	Sample / Identification Summary	Sample ID	Sample Date	% Asbestos & Fibre Type
528	Classroom	Ceiling	Ceiling Tile 2' x 4'	Short Fissure Random Pinhole	-	Non ACM	HM	S01	10-May-18	ND
528	Classroom	Ceiling	Ceiling Tile 1' x 1'	Medium and Small Hole (Cellulose)	-	Non ACM	-	-	-	-
530	Classroom	Floor	Vinyl Floor Tile 12"x 12"	Brown with White and Brown Spots	-	Non ACM	SL	S53abc	10-Mar-08	ND
530	Classroom	Wall	Plaster	-	-	Non ACM	HM	S19	10-Mar-08	ND
530	Classroom	Wall	Concrete	-	-	Non ACM	-	-	-	-
530	Classroom	Ceiling	Ceiling Tile 2' x 4'	Short Fissure Random Pinhole	-	Non ACM	HM	S01	10-May-18	ND
530	Classroom	Ceiling	Ceiling Tile 1' x 1'	Large/Medium Pinhole	-	Non ACM	HM	S13	10-May-18	ND
531	Storage	Floor	Vinyl Floor Tile 12"x 12"	Brown with White and Brown Spots	-	Non ACM	SL	S53abc	10-Mar-08	ND
531	Storage	Wall	Plaster	-	-	Non ACM	HM	S19	10-Mar-08	ND
531	Storage	Ceiling	Ceiling Tile 1' x 1'	Large/Medium Pinhole	-	Non ACM	HM	S13	10-May-18	ND
532	Classroom	Floor	Vinyl Floor Tile 12"x 12"	Brown Dense Fleck (Post 2010)	-	Non ACM	-	-	-	-
532	Classroom	Wall	Plaster	-	-	Non ACM	HM	S19	10-Mar-08	ND
532	Classroom	Wall	Concrete	-	-	Non ACM	-	-	-	-
532	Classroom	Ceiling	Ceiling Tile 2' x 4'	Short Fissure Random Pinhole	-	Non ACM	HM	S01	10-May-18	ND
532	Classroom	Ceiling	Ceiling Tile 1' x 1'	Medium and Small Hole (Cellulose)	-	Non ACM	-	-	-	-
533	Office	Floor	Vinyl Floor Tile 9"x 9"	Grey/Tan with White	NF	ACM	SL	S51abc	10-Mar-08	1.4% Chrysotile
533	Office	Wall	Plaster	-	-	Non ACM	HM	S19	10-Mar-08	ND
533	Office	Ceiling	Ceiling Tile 2' x 4'	Short Fissure Random Pinhole	-	Non ACM	HM	S01	10-May-18	ND
533	Office	Ceiling	Ceiling Tile 1' x 1'	Large/Medium Pinhole	-	Non ACM	HM	S13	10-May-18	ND
533A	Staff Work Room	Floor	Vinyl Floor Tile 9"x 9"	Tan with Red and Black	NF	ACM	SL	S28abc	10-Mar-08	4.1% Chrysotile
533A	Staff Work Room	Wall	Plaster	-	-	Non ACM	HM	S19	10-Mar-08	ND
533A	Staff Work Room	Wall	Drywall	Drywall Joint Compound	NF	ACM	HM	S61	10-Mar-08	1.3% Chrysotile
533A	Staff Work Room	Ceiling	Ceiling Tile 2' x 4'	Short Fissure Random Pinhole	-	Non ACM	HM	S01	10-May-18	ND
533A	Staff Work Room	Ceiling	Ceiling Tile 1' x 1'	Large/Medium Pinhole	-	Non ACM	HM	S13	10-May-18	ND
533A	Staff Work Room	Ceiling	Plaster	-	-	Non ACM	HM	S19	10-Mar-08	ND
533B	Washroom	Floor	Vinyl Floor Tile 9"x 9"	Tan with Red and Black	NF	ACM	SL	S28abc	10-Mar-08	4.1% Chrysotile
533B	Washroom	Wall	Plaster	-	-	Non ACM	HM	S19	10-Mar-08	ND
533B	Washroom	Ceiling	Plaster	-	-	Non ACM	HM	S19	10-Mar-08	ND
533C	Washroom	Floor	Vinyl Floor Tile 9"x 9"	Tan with Red and Black	NF	ACM	SL	S28abc	10-Mar-08	4.1% Chrysotile
533C	Washroom	Wall	Plaster	-	-	Non ACM	HM	S19	10-Mar-08	ND
533C	Washroom	Ceiling	Plaster	-	-	Non ACM	HM	S19	10-Mar-08	ND
534	Classroom	Floor	Vinyl Floor Tile 9"x 9"	Dark Green with Green and White	NF	ACM	SL	S49abc	10-Mar-08	0.75% Chrysotile



<b>School Name</b> <b>Waterloo-Oxford District Secondary School</b> <b>Date Built:</b> Original: 1955 Addition(s): 1958, 1962, 1966, 1971, 1972, 2000, 2001, 2011	<b>Legend:</b> <b>HM</b> - Homogenous Material - homogeneous with previously sampled material <b>SL</b> - Sample Location - Material Sampled <b>VC</b> - Visually Confirmed - Material not sampled, deemed ACM <b>NF</b> - Non-Friable <b>F</b> - Friable	<b>Notes:</b> All quantities provided on Figures, if known. Refer to the Asbestos Audit Update Report for condition of ACM and recommended actions. Dates provided in Material Description/Room Description columns indicates date of installation/renovation and confirms the finishes as non-ACM.
---	--	---

WRDSB Fixed Reference Number	Room Description	Inspected Item	Inspected Material	Material Description	Friability	Asbestos Classification	Sample / Identification Summary	Sample ID	Sample Date	% Asbestos & Fibre Type
534	Classroom	Wall	Plaster	-	-	Non ACM	HM	S19	10-Mar-08	ND
534	Classroom	Wall	Concrete	-	-	Non ACM	-	-	-	-
534	Classroom	Ceiling	Ceiling Tile 2' x 4'	Dense Short Fissure Random Pinhole	-	Non ACM	SL	S50abc	10-Mar-08	ND
534	Classroom	Ceiling	Ceiling Tile 1' x 1'	Large/Medium Pinhole	-	Non ACM	HM	S13	10-May-18	ND
535	Classroom	Floor	Vinyl Floor Tile 9"x 9"	Tan with Red and Black	NF	ACM	SL	S28abc	10-Mar-08	4.1% Chrysotile
535	Classroom	Wall	Plaster	-	-	Non ACM	HM	S02	10-Mar-08	ND
535	Classroom	Wall	Concrete	-	-	Non ACM	-	-	-	-
535	Classroom	Ceiling	Ceiling Tile 2' x 4'	Short Fissure Random Pinhole	-	Non ACM	HM	S01	10-May-18	ND
535	Classroom	Ceiling	Ceiling Tile 1' x 1'	Large/Medium Pinhole	-	Non ACM	HM	S13	10-May-18	ND
536	Classroom	Floor	Vinyl Floor Tile 9"x 9"	Light Brown with Brown and White	NF	ACM	SL	S48abc	10-Mar-08	1.2% Chrysotile
536	Classroom	Wall	Plaster	-	-	Non ACM	HM	S02	10-Mar-08	ND
536	Classroom	Wall	Concrete	-	-	Non ACM	-	-	-	-
536	Classroom	Ceiling	Ceiling Tile 2' x 4'	Short Fissure Random Pinhole	-	Non ACM	HM	S01	10-May-18	ND
536	Classroom	Ceiling	Ceiling Tile 1' x 1'	Large/Medium Pinhole	-	Non ACM	HM	S13	10-May-18	ND
537	Classroom	Floor	Vinyl Floor Tile 12"x 12"	Tan/Olive with White and Brown	NF	ACM	SL	S46abc	-	-
537	Classroom	Wall	Drywall	Drywall Joint Compound	-	Non ACM	HM	S01	-	-
537	Classroom	Wall	Concrete	-	-	Non ACM	-	-	-	-
537	Classroom	Ceiling	Ceiling Tile 2' x 4'	Short Fissure Random Pinhole (2000)	NF	Non ACM	-	-	-	-
537	Classroom	Ceiling	Ceiling Tile 1' x 1'	Thick Fissure Small Pinhole	-	Non ACM	HM	S45	10-Mar-08	ND
537A	Office	Floor	Vinyl Floor Tile 9"x 9"	Tan with Red and Black	NF	ACM	SL	S28abc	10-Mar-08	4.1% Chrysotile
537A	Office	Wall	Plaster	-	-	Non ACM	HM	S02	10-Mar-08	ND
537A	Office	Wall	Concrete	-	-	Non ACM	-	-	-	-
537A	Office	Ceiling	Ceiling Tile 2' x 4'	Short Fissure Random Pinhole	-	Non ACM	HM	S01	10-May-18	ND
537A	Office	Ceiling	Ceiling Tile 1' x 1'	Large/Medium Pinhole	-	Non ACM	HM	S13	10-May-18	ND
537B	Show Room	Floor	Carpet	-	-	Non ACM	-	-	-	-
537B	Show Room	Wall	Plaster	-	-	Non ACM	HM	S02	10-Mar-08	ND
537B	Show Room	Ceiling	Ceiling Tile 2' x 4'	Short Fissure Random Pinhole	-	Non ACM	HM	S01	10-May-18	ND
537C	Kiln Room	Floor	Vinyl Floor Tile 9"x 9"	Tan with Red and Black	NF	ACM	HM	S28	10-Mar-08	4.1% Chrysotile
537C	Kiln Room	Wall	Plaster	-	-	Non ACM	HM	S02	10-Mar-08	ND
537C	Kiln Room	Wall	Concrete	-	-	Non ACM	-	-	-	-
537C	Kiln Room	Ceiling	Ceiling Tile 2' x 4'	Short Fissure Random Pinhole	-	Non ACM	HM	S01	10-May-18	ND
537C	Kiln Room	Ceiling	Drywall	No Drywall Joint Compound	-	Non ACM	-	-	-	-





<b>School Name</b> <b>Waterloo-Oxford District Secondary School</b> <b>Date Built:</b> Original: 1955 Addition(s): 1958, 1962, 1966, 1971, 1972, 2000, 2001, 2011	<b>Legend:</b> <b>HM</b> - Homogenous Material - homogeneous with previously sampled material <b>SL</b> - Sample Location - Material Sampled <b>VC</b> - Visually Confirmed - Material not sampled, deemed ACM <b>NF</b> - Non-Friable <b>F</b> - Friable	<b>Notes:</b> All quantities provided on Figures, if known. Refer to the Asbestos Audit Update Report for condition of ACM and recommended actions. Dates provided in Material Description/Room Description columns indicates date of installation/renovation and confirms the finishes as non-ACM.
---	--	---

WRDSB Fixed Reference Number	Room Description	Inspected Item	Inspected Material	Material Description	Friability	Asbestos Classification	Sample / Identification Summary	Sample ID	Sample Date	% Asbestos & Fibre Type
538	Classroom	Floor	Vinyl Floor Tile 12"x 12"	Orange/Red with White	NF	ACM	SL	S30abc	10-Mar-08	5.0% Chrysotile
538	Classroom	Wall	Drywall	Drywall Joint Compound	-	Non ACM	HM	S01	-	-
538	Classroom	Wall	Concrete	-	-	Non ACM	-	-	-	-
538	Classroom	Ceiling	Ceiling Tile 2' x 4'	Short Fissure Random Pinhole (2000)	NF	Non ACM	-	-	-	-
538	Classroom	Ceiling	Ceiling Tile 1' x 1'	Thick Fissure Small Pinhole	-	Non ACM	HM	S45	10-Mar-08	ND
539	Classroom	Floor	Vinyl Floor Tile 12"x 12"	Tan/Olive with White and Brown	NF	ACM	SL	S46abc	-	-
539	Classroom	Wall	Drywall	Drywall Joint Compound	-	Non ACM	HM	S01	-	-
539	Classroom	Wall	Concrete	-	-	Non ACM	-	-	-	-
539	Classroom	Ceiling	Ceiling Tile 2' x 4'	Short Fissure Random Pinhole (2000)	NF	Non ACM	-	-	-	-
539	Classroom	Ceiling	Ceiling Tile 1' x 1'	Thick Fissure Small Pinhole	-	Non ACM	HM	S45	10-Mar-08	ND
540	Classroom	Floor	Vinyl Floor Tile 12"x 12"	Olive and White	NF	ACM	SL	S44abc	10-Mar-08	2.4% Chrysotile
540	Classroom	Wall	Concrete	-	-	Non ACM	-	-	-	-
540	Classroom	Ceiling	Ceiling Tile 2' x 4'	Short Fissure Random Pinhole (2000)	NF	Non ACM	-	-	-	-
540	Classroom	Ceiling	Ceiling Tile 1' x 1'	Thick Fissure Small Pinhole	-	Non ACM	SL	S45abc	10-Mar-08	ND
550	Classroom	Floor	Concrete	-	-	Non ACM	-	-	-	-
550	Classroom	Wall	Concrete	-	-	Non ACM	-	-	-	-
550	Classroom	Ceiling	Metal Pan	-	-	Non ACM	-	-	-	-
550	Classroom	Ducting	Flex Joint	-	NF	ACM	VC	-	-	-
550	Classroom	Piping	Pipe Fitting	Parged Cement	F	ACM	HM	1680.894.03	11-Sep-90	50-75% Chrysotile
551	Projection Room	Floor	Vinyl Floor Tile 12"x 12"	Brown with Brown and White Fleck	-	Non ACM	HM	S53	13-Mar-08	ND
551	Projection Room	Wall	Concrete	-	-	Non ACM	-	-	-	-
551	Projection Room	Ceiling	Ceiling Tile 2' x 2'	Short Fissure Random Pinhole	-	Non ACM	HM	S01	10-May-18	ND
554	Fan Room (Above 555)	Floor	Concrete	-	-	Non ACM	-	-	-	-
554	Fan Room (Above 555)	Wall	Concrete	-	-	Non ACM	-	-	-	-
554	Fan Room (Above 555)	Ceiling	Metal Pan	-	-	Non ACM	-	-	-	-
554	Fan Room (Above 555)	Ducting	Flex Joint	-	NF	ACM	VC	-	-	-
554	Fan Room (Above 555)	Piping	Pipe Fitting	Parged Cement	F	ACM	HM	1680.894.03	11-Sep-90	50-75% Chrysotile
555	Equipment Storage	Floor	Concrete	-	-	Non ACM	-	-	-	-
555	Equipment Storage	Wall	Concrete	-	-	Non ACM	-	-	-	-
555	Equipment Storage	Wall	Drywall	No Drywall Joint Compound	-	Non ACM	-	-	-	-
555	Equipment Storage	Piping	Pipe Fitting	Parged Cement	F	ACM	HM	1680.894.03	11-Sep-90	50-75% Chrysotile
556	Fly Gallery	Floor	Concrete	-	-	Non ACM	-	-	-	-



<b>School Name</b> <b>Waterloo-Oxford District Secondary School</b> <b>Date Built:</b> Original: 1955 Addition(s): 1958, 1962, 1966, 1971, 1972, 2000, 2001, 2011	<b>Legend:</b> HM - Homogenous Material - homogeneous with previously sampled material SL - Sample Location - Material Sampled VC - Visually Confirmed - Material not sampled, deemed ACM NF - Non-Friable F- Friable	<b>Notes:</b> All quantities provided on Figures, if known. Refer to the Asbestos Audit Update Report for condition of ACM and recommended actions. Dates provided in Material Description/Room Description columns indicates date of installation/renovation and confirms the finishes as non-ACM.
---	--	---

WRDSB Fixed Reference Number	Room Description	Inspected Item	Inspected Material	Material Description	Friability	Asbestos Classification	Sample / Identification Summary	Sample ID	Sample Date	% Asbestos & Fibre Type
556	Fly Gallery	Wall	Concrete	-	-	Non ACM	-	-	-	-
556	Fly Gallery	Ceiling	Metal Pan	-	-	Non ACM	-	-	-	-
556	Fly Gallery	Piping	Pipe Fitting	Parged Cement	F	ACM	HM	1680.894.03	11-Sep-90	50-75% Chrysotile
556	Fly Gallery	Wall	Transite	Asbestos Cement Board	NF	ACM	VC			
557	Mechanical Room	Floor	Concrete	-	-	Non ACM	-	-	-	-
557	Mechanical Room	Wall	Concrete	-	-	Non ACM	-	-	-	-
557	Mechanical Room	Ceiling	Plaster	-	-	Non ACM	SL	S60abc	10-Mar-08	ND
557	Mechanical Room	Piping	Pipe Fitting	Parged Cement	F	ACM	HM	1680.894.03	11-Sep-90	50-75% Chrysotile
557	Mechanical Room	Ducting	Flex Joint	-	NF	ACM	VC	-	-	-
557	Mechanical Room	Piping	Pipe Insulation	Air Cell	F	ACM	HM	1680.894.04	11-Sep-90	>75% Amosite
558	Duct Space	Floor	Concrete	-	-	Non ACM	-	-	-	-
558	Duct Space	Wall	Concrete	-	-	Non ACM	-	-	-	-
558	Duct Space	Wall	Brick	-	-	Non ACM	-	-	-	-
558	Duct Space	Ceiling	Metal Pan	-	-	Non ACM	-	-	-	-
558	Duct Space	Ceiling	Drywall	Drywall Joint Compound	NF	ACM	SL	S61abc	10-Mar-08	1.3% Chrysotile
558	Duct Space	Piping	Pipe Fitting	Parged Cement	F	ACM	HM	1680.894.03	11-Sep-90	50-75% Chrysotile
558	Duct Space	-	Texture Coat	Grey	-	Non ACM	SL	S62abc	10-Mar-08	ND
559	Washroom	Floor	Vinyl Floor Tile 12"x 12"	Beige with Beige Fleck	-	Non ACM	HM	S57	10-Mar-08	ND
559	Washroom	Wall	Plaster	-	-	Non ACM	HM	S27	10-Mar-08	ND
559	Washroom	Ceiling	Ceiling Tile 1' x 1'	Large/Medium Pinhole	-	Non ACM	HM	S13	10-May-18	ND
560	Nurse's Office	Floor	Vinyl Floor Tile 9"x 9"	Grey with White and Grey Streaks	NF	ACM	HM	S59	10-Mar-08	1.5% Chrysotile
560	Nurse's Office	Wall	Plaster	-	-	Non ACM	HM	S27	10-Mar-08	ND
560	Nurse's Office	Wall	Plaster	-	-	Non ACM	HM	S27	10-Mar-08	ND
561	Fan Room	Floor	Concrete	-	-	Non ACM	-	-	-	-
561	Fan Room	Wall	Concrete	-	-	Non ACM	-	-	-	-
561	Fan Room	Wall	Plaster	-	-	Non ACM	HM	S82	13-Mar-08	ND
561	Fan Room	Ceiling	Metal Pan	-	-	Non ACM	-	-	-	-
561	Fan Room	Ducting	Flex Joint	-	NF	ACM	VC	-	-	-
561	Fan Room	Piping	Pipe Fitting	Parged Cement	F	ACM	HM	1680.894.03	11-Sep-90	50-75% Chrysotile
821	Corridor - 1966 Addition	Floor	Terrazzo	-	-	Non ACM	-	-	-	-
821	Corridor - 1966 Addition	Wall	Plaster	-	-	Non ACM	HM	S72, S82	13-Mar-08	ND
821	Corridor - 1966 Addition	Ceiling	Ceiling Tile 2 x 2	Short Fissure Random Pinhole	NF	ACM		-	-	-



<b>School Name</b> <b>Waterloo-Oxford District Secondary School</b> <b>Date Built:</b> Original: 1955 Addition(s): 1958, 1962, 1966, 1971, 1972, 2000, 2001, 2011	<b>Legend:</b> <b>HM</b> - Homogenous Material - homogeneous with previously sampled material <b>SL</b> - Sample Location - Material Sampled <b>VC</b> - Visually Confirmed - Material not sampled, deemed ACM <b>NF</b> - Non-Friable <b>F</b> - Friable	<b>Notes:</b> All quantities provided on Figures, if known. Refer to the Asbestos Audit Update Report for condition of ACM and recommended actions. Dates provided in Material Description/Room Description columns indicates date of installation/renovation and confirms the finishes as non-ACM.
---	--	---

WRDSB Fixed Reference Number	Room Description	Inspected Item	Inspected Material	Material Description	Friability	Asbestos Classification	Sample / Identification Summary	Sample ID	Sample Date	% Asbestos & Fibre Type
821	Corridor - 1966 Addition	Ceiling	Ceiling Tile 2' x 2'	Large & Small Pinhole (Drywall)	-	Non ACM	-	-	-	-
821	Corridor - 1966 Addition	Above Ceiling	Drywall	No Drywall Joint Compound	-	Non ACM	-	-	-	-
821	Corridor - 1966 Addition	Firespray	Firespray	Colour Sprayed Applied (2021)	-	Non ACM	-	-	-	-
821	Corridor - 1966 Addition	Wall Cavities	Firespray	Sprayed Applied	F	ACM	HM	S06	13-Mar-08	4.1% Chrysotile
822	Corridor near 561	Floor	Vinyl Floor Tile 9"x 9"	Grey with White and Grey Streaks	NF	ACM	SL	S59abc	10-Mar-08	1.5% Chrysotile
822	Corridor near 561	Wall	Plaster	-	-	Non ACM	HM	S82	13-Mar-08	ND
822	Corridor near 561	Ceiling	Plaster	-	-	Non ACM	HM	S82	13-Mar-08	ND
823	Corridor - 1962	Floor	Terrazzo	-	-	Non ACM	-	-	-	-
823	Corridor - 1962	Wall	Plaster	-	-	Non ACM	HM	S19	10-Mar-08	ND
823	Corridor - 1962	Ceiling	Ceiling Tile 2' x 4'	Short Fissure Random Pinhole	-	Non ACM	HM	S01	10-May-18	ND
823	Corridor - 1962	Ceiling	Ceiling Tile 2' x 4'	Textured Pinhole	-	Non ACM	SL	S54abc	10-Mar-08	ND
823	Corridor - 1962	Piping	Pipe Insulation	Fiberglass insulation	-	Non ACM	-	-	-	-
823	Corridor - 1962	Piping	Pipe Fitting	Parged Cement	F	ACM	HM	1680.894.03	11-Sep-90	50-75% Chrysotile
824	Corridor - 1972	Floor	Terrazzo	-	-	Non ACM	-	-	-	-
824	Corridor - 1972	Wall	Plaster	-	-	Non ACM	HM	S02	10-Mar-08	ND
824	Corridor - 1962	Ceiling	Ceiling Tile 1' x 1'	Large/Medium Pinhole	-	Non ACM	SL	S13ABC	10-May-18	ND
824	Corridor - 1972	Ceiling	Ceiling Tile 2' x 4'	Short Fissure Random Pinhole	-	Non ACM	HM	S01	10-May-18	ND
824	Corridor - 1966	Ceiling	Drywall	No Drywall Joint Compound	-	Non ACM	-	-	-	-
824	Corridor - 1966	Firespray	Firespray	Troweled-applied	F	ACM	SL	S06abc	10-Mar-08	4.1% Chrysotile
824	Corridor - 1972	Ducting	Duct Insulation	Fiberglass insulation	-	Non ACM	-	-	-	-
824	Corridor - 1972	Ducting	Flex Joint	-	NF	ACM	VC	-	-	-
901	Stairwell	Floor	Terrazzo	-	-	Non ACM	-	-	-	-
901	Stairwell	Wall	Plaster	-	-	Non ACM	HM	S72, S82	13-Mar-08	ND
901	Stairwell	Ceiling	Ceiling Tile 2' x 4'	Random Fissure Random Pinhole (2021)	-	Non ACM	-	-	-	-
901	Stairwell	Ceiling	Drywall	Drywall Joint Compound	NF	ACM	HM	S81	10-Mar-08	1% Chrysotile
902	Stairwell	Floor	Terrazzo	-	-	Non ACM	-	-	-	-
902	Stairwell	Wall	Plaster	-	-	Non ACM	HM	S72, S82	13-Mar-08	ND
902	Stairwell	Ceiling	Ceiling Tile 2' x 4'	Random Fissure Random Pinhole (2021)	-	Non ACM	-	-	-	-
902	Stairwell	Ceiling	Drywall	Drywall Joint Compound	NF	ACM	HM	S81	10-Mar-08	1% Chrysotile
903	Stairwell	Floor	Terrazzo	-	-	Non ACM	-	-	-	-
903	Stairwell	Wall	Concrete	-	-	Non ACM	-	-	-	-
903	Stairwell	Wall	Plaster	-	-	Non ACM	HM	S82	13-Mar-08	ND

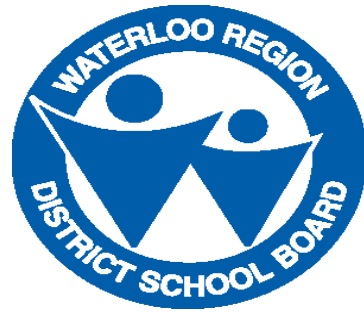

	<b>School Name</b>	<b>Legend:</b>	<b>Notes:</b>
	Waterloo-Oxford District Secondary School	<b>HM</b> - Homogenous Material - homogeneous with previously sampled material <b>SL</b> - Sample Location - Material Sampled <b>VC</b> - Visually Confirmed - Material not sampled, deemed ACM <b>NF</b> - Non-Friable <b>F</b> - Friable	All quantities provided on Figures, if known. Refer to the Asbestos Audit Update Report for condition of ACM and recommended actions.
	<b>Date Built:</b>		
	Original: 1955		Dates provided in Material Description/Room Description columns indicates date of installation/renovation and confirms the finishes as non-ACM.
Addition(s): 1958, 1962, 1966, 1971, 1972, 2000, 2001, 2011			

WRDSB Fixed Reference Number	Room Description	Inspected Item	Inspected Material	Material Description	Friability	Asbestos Classification	Sample / Identification Summary	Sample ID	Sample Date	% Asbestos & Fibre Type
903	Stairwell	Ceiling	Plaster	-	-	Non ACM	HM	S82	13-Mar-08	ND
904	Stairwell	Floor	Terrazzo	-	-	Non ACM	-	-	-	-
904	Stairwell	Wall	Concrete	-	-	Non ACM	-	-	-	-
904	Stairwell	Wall	Plaster	-	-	Non ACM	HM	S82	13-Mar-08	ND
904	Stairwell	Ceiling	Plaster	-	-	Non ACM	HM	S82	13-Mar-08	ND
906	Stairwell	Floor	Terrazzo	-	-	Non ACM	-	-	-	-
906	Stairwell	Wall	Concrete	-	-	Non ACM	-	-	-	-
906	Stairwell	Ceiling	Ceiling Tile 2' x 2'	Dense Fissure Small Pinhole	-	Non ACM	SL	S29abc	13-Mar-08	ND
906	Stairwell	Piping	Pipe Insulation	Fibreglass insulation	-	Non ACM	-	-	-	-
907	Stairwell	Floor	Vinyl Floor Tile 12"x 12"	Grey Dense Fleck (Post 2010)	-	Non ACM	-	-	-	-
907	Stairwell	Wall	Concrete	-	-	Non ACM	-	-	-	-
907	Stairwell	Ceiling	Drywall	Drywall Joint Compound	NF	ACM	HM	S61	10-Mar-08	1.3% Chrysotile
908	Stairwell	Floor	Terrazzo	-	-	Non ACM	-	-	-	-
908	Stairwell	Wall	Plaster	-	-	Non ACM	HM	S24, S43	10-Mar-08	ND
908	Stairwell	Wall	Concrete	-	-	Non ACM	-	-	-	-
908	Stairwell	Ceiling	Ceiling Tile 1' x 1'	Large and Small Pinhole	-	Non ACM	HM	S04abc	10-Mar-08	ND
908	Stairwell	Ceiling	Plaster	-	-	Non ACM	HM	S24, S43	10-Mar-08	ND
<b>Summary of Potential ACM Hidden or Not Assessed</b>										
300	Boiler Room	Boiler Refractory	Not Inspected							
	Throughout Building	Not Inspected	Not Inspected	Wall Cavity Insulation						
	Throughout Building	Not Inspected	Not Inspected	Door Core Insulation						

# Appendix B

---

## Figures

\*\*\*REFER TO APPENDIX A: ASBESTOS MANAGEMENT DATABASE FOR FULL LIST OF ASBESTOS-CONTAINING MATERIALS (ACM).  
 \*\*\*ALL ACM MAY NOT BE DEPICTED IN THIS FIGURE.

**NOTES:**  
 ALL DRAWINGS TO BE REFERENCED WITH THE ASSOCIATED REPORT. LOCATIONS AND QUANTITIES ARE APPROXIMATE.  
 ALL KNOWN OR SUSPECT ASBESTOS-CONTAINING MATERIALS AND/OR DESIGNATED MATERIALS ARE NOT DEPICTED ON THIS DRAWING. REFER TO THE REPORT FOR A COMPLETE LIST OF IDENTIFIED MATERIALS.  
 THIS FIGURE IS COLOUR DEPENDENT. PHOTOCOPIES MAY ALTER INTERPRETATION OF THE FIGURE. ALWAYS REFER TO ORIGINAL DRAWINGS AND REPORT.

**Legend**

- 13 Fixed Reference Number
- No Access
- Post 1986 Construction

**Asbestos-Containing Materials (ACM):**

- Floor Tile
- Rolled Flooring
- Ceiling Tile (Ceiling Surface)
- Ceiling Tile (Located Above non-ACM Ceiling Tiles in Ceiling Space)
- Friable Soft Textured Ceiling
- Non-Friable Hard Textured Ceiling
- Spray-On Fire Proofing
- Trowel Applied Fire Proofing
- Transite (Asbestos Cement) Paneling
- Duct Insulation
- Pipe Fitting Insulation w Quantity (Brackets Indicate # of Damaged Fittings)
- Pipe Insulation (Vertical and Horizontal)
- Transite (Asbestos Cement) Pipe (Vertical and Horizontal)
- Duct Expansion Joints w Quantity (Brackets Indicate # of Damaged Joints)
- Friable Debris



Ph. (519) 743-6500 www.mte85.com

CLIENT  
 WATERLOO REGION DISTRICT SCHOOL BOARD

PROJECT  
 2021 ASBESTOS AUDIT UPDATE

DRAWING  
 WATERLOO-OXFORD DISTRICT SECONDARY SCHOOL  
 LEVEL ONE

Project Manager	P. Semeniuk	Date	October 2022 Revision
Design By	WRDSB	Project No.	34532-921
Drawn By	P. Semeniuk	Drawing No.	1.0
Scale	N.T.S.		

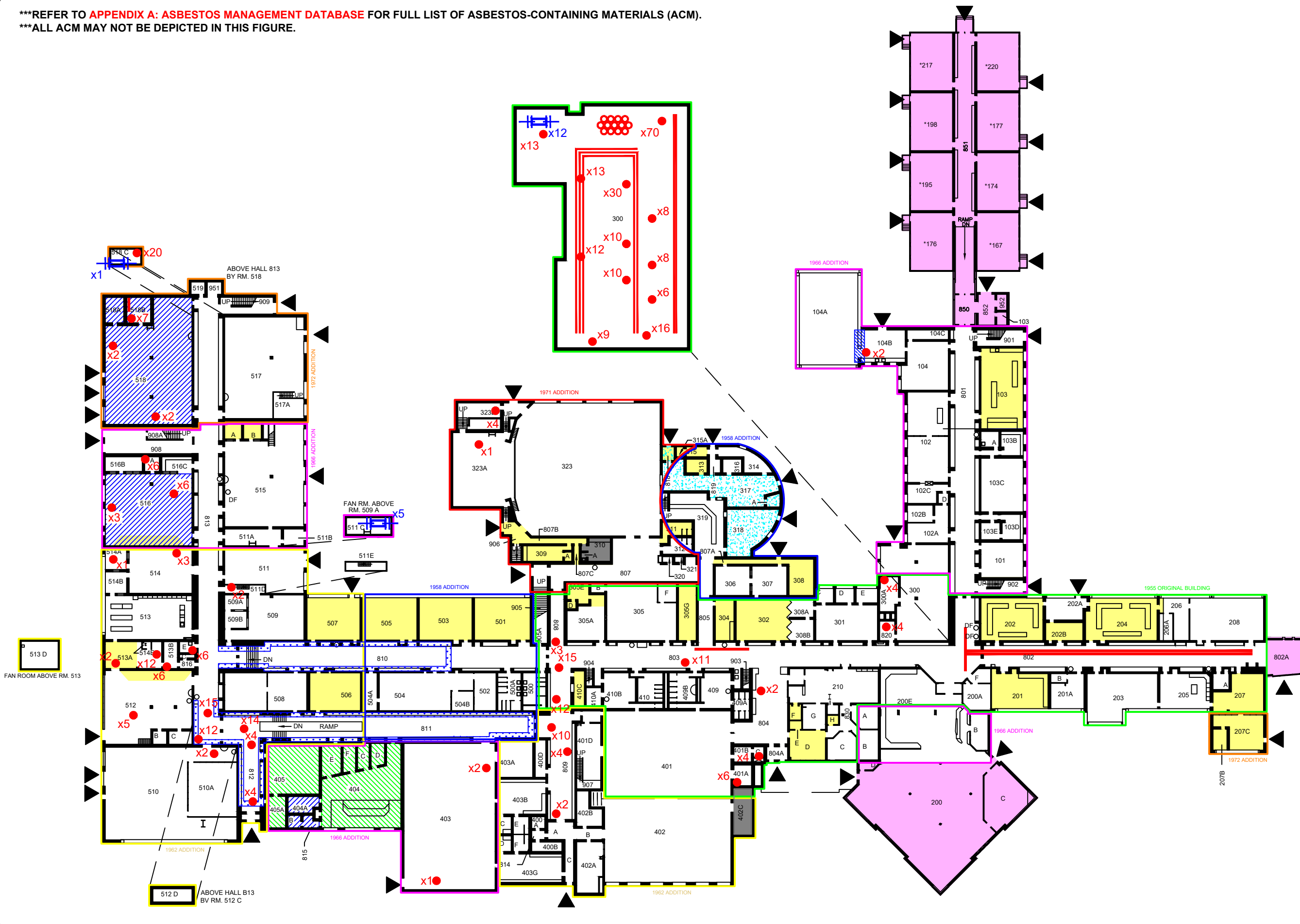

\*\*\*REFER TO APPENDIX A: ASBESTOS MANAGEMENT DATABASE FOR FULL LIST OF ASBESTOS-CONTAINING MATERIALS (ACM).

\*\*\*ALL ACM MAY NOT BE DEPICTED IN THIS FIGURE.

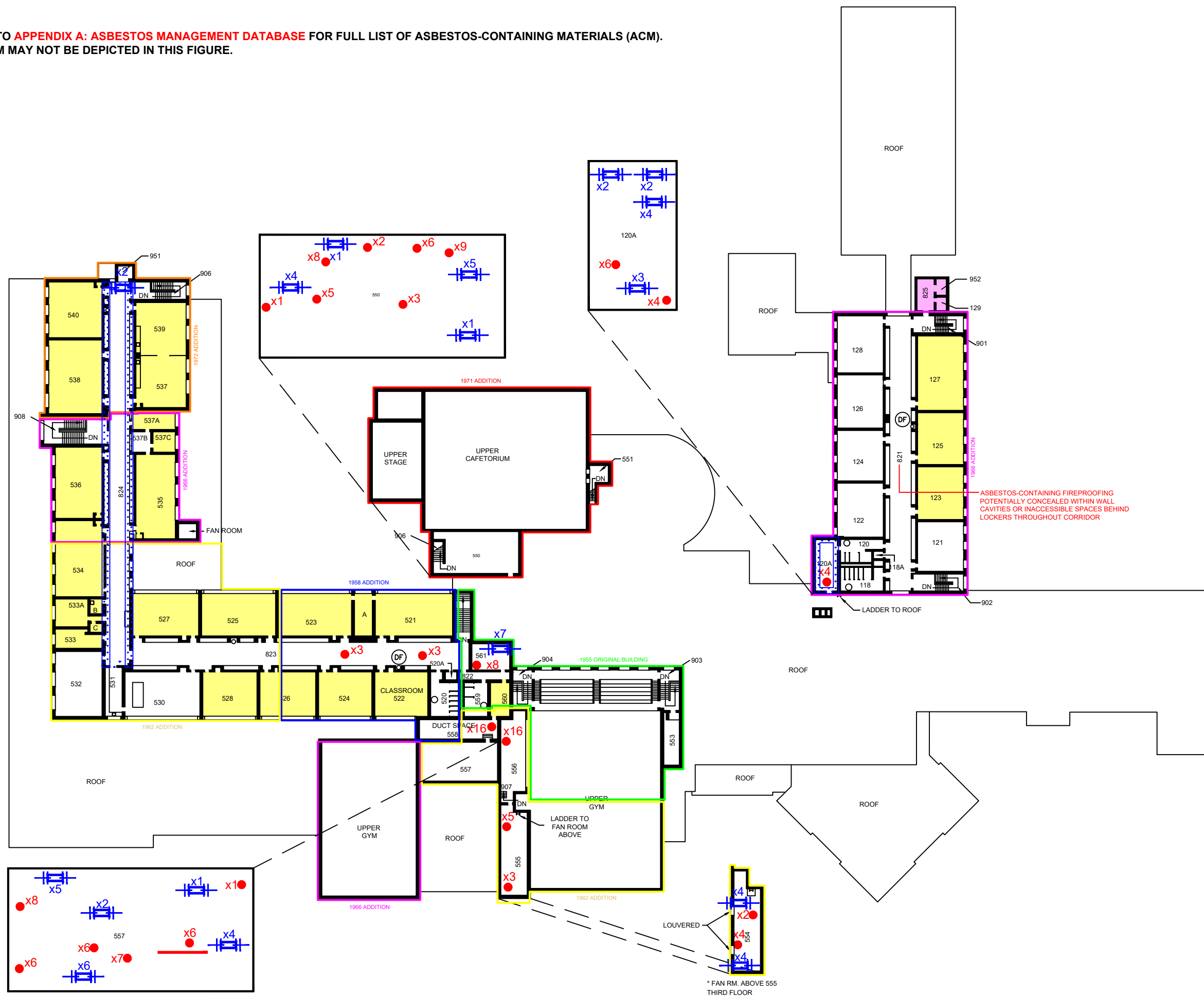

**NOTES:**

ALL DRAWINGS TO BE REFERENCED WITH THE ASSOCIATED REPORT. LOCATIONS AND QUANTITIES ARE APPROXIMATE.

ALL KNOWN OR SUSPECT ASBESTOS-CONTAINING MATERIALS AND/OR DESIGNATED MATERIALS ARE NOT DEPICTED ON THIS DRAWING. REFER TO THE REPORT FOR A COMPLETE LIST OF IDENTIFIED MATERIALS.

THIS FIGURE IS COLOUR DEPENDENT. PHOTOCOPIES MAY ALTER INTERPRETATION OF THE FIGURE. ALWAYS REFER TO ORIGINAL DRAWINGS AND REPORT.

**Legend**

- 13 Fixed Reference Number
- No Access
- Post 1986 Construction

**Asbestos-Containing Materials (ACM):**

- Floor Tile
- Rollled Flooring
- Ceiling Tile
- Friable Soft Textured Ceiling
- Non-Friable Hard Textured Ceiling
- Spray-On Fire Proofing
- Trowel Applied Fire Proofing
- Transite (Asbestos Cement) Paneling
- Duct Insulation
- x2(1) Pipe Fitting Insulation w Quantity (Brackets Indicate # of Damaged Fittings)
- Pipe Insulation (Vertical and Horizontal)
- Transite (Asbestos Cement) Pipe (Vertical and Horizontal)
- x2(1) Duct Expansion Joints w Quantity (Brackets Indicate # of Damaged Joints)
- Friable Debris



Ph. (519) 743-6500 www.mte85.com

CLIENT  
WATERLOO REGION DISTRICT SCHOOL BOARD

PROJECT  
2021 ASBESTOS AUDIT UPDATE

DRAWING  
WATERLOO-OXFORD DISTRICT SECONDARY SCHOOL

LEVEL TWO

Project Manager	P. Semeniuk	Date	October 2022 Revision
Design By	WRDSB	Project No.	34532-921
Drawn By	P. Semeniuk	Drawing No.	2.0
Scale	N.T.S.		

\* FAN RM. ABOVE 555 THIRD FLOOR

# Appendix C

---

## Tables











TABLE 1 - INTERNAL ABATEMENT MANAGEMENT						
Waterloo Oxford Secondary School						
Material	WRDSB Fixed Reference Number	Material Description	Approximate Quantity	Photograph - Context	Photograph - Detail	Required Action
Asbestos Non-Friable	103	9" x 9" Tan Floor Tile	2 tiles			Monitor Annually
Asbestos Non-Friable	125	9" x 9" Green Floor Tile	5 Tiles			Monitor Annually
Asbestos Non-Friable	200	Drywall	<1 m <sup>2</sup>			Monitor Annually
Asbestos Non-Friable	200	Drywall	<1 m <sup>2</sup>			Monitor Annually

Table 1 and 2 - Damaged Materials - Waterloo Oxford District Secondary School









TABLE 1 - INTERNAL ABATEMENT MANAGEMENT						
Waterloo Oxford Secondary School						
Material	WRDSB Fixed Reference Number	Material Description	Approximate Quantity	Photograph - Context	Photograph - Detail	Required Action
Asbestos Non-Friable	207	12"x12" beige Floor Tiles cracking and degrading at floor seam	40 tiles			Removal in accordance with O. Reg. 278/05 as a Type 1 Operation
Asbestos Non-Friable	101, 102, 102A, 102B, 103, 103C, 103F, 104, 122, 124, 126, 128	1' x 1' Ceiling Tiles - Damage at hangers and penetrations	Throughout			Monitor Annually
Asbestos Non-Friable	404B	1' x 1' Ceiling Tiles	19 tiles			Removal in accordance with O. Reg. 278/05 as a Type 1 Operation
Asbestos Non-Friable	802 at room 206	Drywall	<1 m <sup>2</sup>			Monitor Annually

Table 1 and 2 - Damaged Materials - Waterloo Oxford District Secondary School

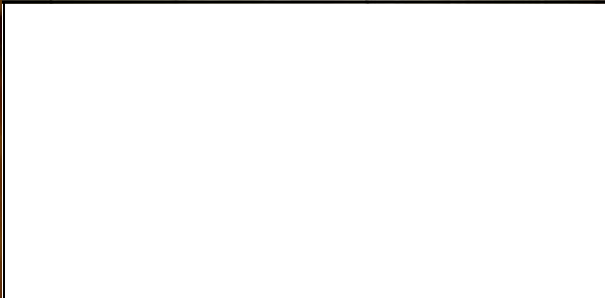





TABLE 1 - INTERNAL ABATEMENT MANAGEMENT						
Waterloo Oxford Secondary School						
Material	WRDSB Fixed Reference Number	Material Description	Approximate Quantity	Photograph - Context	Photograph - Detail	Required Action
Asbestos Non-Friable	807B	12"x12" orange Floor Tiles	3 Tiles			Monitor Annually
Asbestos Non-Friable	809	2' x 2' Ceiling Tiles - Dense Fissure Random Pinhole	15+ Tiles			Removal in accordance with O. Reg. 278/05 as a Type 1 Operation
Asbestos Non-Friable	822	Exposed Mastic	14 tiles			Repair/Removal in accordance with O. Reg. 278/05 as a Type 1 Operation
Asbestos Non-Friable	906	12"x12" orange Floor Tiles	2 Tiles			Monitor Annually

Table 1 and 2 - Damaged Materials - Waterloo Oxford District Secondary School

<b>TABLE 1 - INTERNAL ABATEMENT MANAGEMENT</b>						
<b>Waterloo Oxford Secondary School</b>						
<b>Material</b>	<b>WRDSB Fixed Reference Number</b>	<b>Material Description</b>	<b>Approximate Quantity</b>	<b>Photograph - Context</b>	<b>Photograph - Detail</b>	<b>Required Action</b>
<p>Notes:</p> <p>1) A copy of this report should be provided to all prospective contractors prior to tender or quotation, in accordance with Section 30 of the Occupational Health and Safety Act.</p> <p>2) Recommended actions are the minimum required actions, as prescribed by the appropriate Acts, regulations, guidelines, standards, codes and general best practice measures. The Contractor may choose to alter the approach and combine or break out sections of work. This is acceptable provided that the appropriate Acts, regulations, guidelines, standards and codes are followed and afford protection for the health and safety of workers, occupants and the public that is at least equal to the protection that would be provided by complying with the minimum requirements.</p> <p>3) All waste generated is subject to characterization and disposal in accordance with Ontario Regulation 347.</p>						









TABLE 2 - EXTERNAL ABATEMENT MANAGEMENT						
Waterloo Oxford Secondary School						
Material	WRDSB Fixed Reference Number	Material Description	Approximate Quantity	Photograph - Context	Photograph - Detail	Required Action
Asbestos Friable	104B	Insulation on Pipe Fittings	2			Removal in accordance with O. Reg. 278/05 as a Type 2 Operation
Asbestos Friable	300	Insulation on Pipe Fittings	2			Removal in accordance with O. Reg. 278/05 as a Type 2 Operation
Asbestos Friable	300	Insulation on Pipe Fittings	1			Removal in accordance with O. Reg. 278/05 as a Type 2 Operation
Asbestos Friable	300	Insulation on Pipe Fittings	1			Removal in accordance with O. Reg. 278/05 as a Type 2 Operation

Table 1 and 2 - Damaged Materials - Waterloo Oxford District Secondary School













TABLE 2 - EXTERNAL ABATEMENT MANAGEMENT						
Waterloo Oxford Secondary School						
Material	WRDSB Fixed Reference Number	Material Description	Approximate Quantity	Photograph - Context	Photograph - Detail	Required Action
Asbestos Friable	300	Insulation on Pipe Fittings	1			Removal in accordance with O. Reg. 278/05 as a Type 2 Operation
Asbestos Friable	300	Insulation on Pipe Fittings	2			Removal in accordance with O. Reg. 278/05 as a Type 2 Operation
Asbestos Friable	300	Insulation on Pipe Fittings	1			Removal in accordance with O. Reg. 278/05 as a Type 2 Operation
Asbestos Friable	300	Insulation on Pipe Fittings	1			Removal in accordance with O. Reg. 278/05 as a Type 2 Operation

Table 1 and 2 - Damaged Materials - Waterloo Oxford District Secondary School

TABLE 2 - EXTERNAL ABATEMENT MANAGEMENT						
Waterloo Oxford Secondary School						
Material	WRDSB Fixed Reference Number	Material Description	Approximate Quantity	Photograph - Context	Photograph - Detail	Required Action
Asbestos Friable	300	Insulation on Pipe Fittings	1			Removal in accordance with O. Reg. 278/05 as a Type 2 Operation
Asbestos Non-Friable	518	2" x4" Ceiling Tiles	30+ Tiles			Removal in accordance with O. Reg. 278/05 as a Type 2 Operation

Notes:  
1) A copy of this report should be provided to all prospective contractors prior to tender or quotation, in accordance with Section 30 of the Occupational Health and Safety Act.  
2) Recommended actions are the minimum required actions, as prescribed by the appropriate Acts, regulations, guidelines, standards, codes and general best practice measures. The Contractor may choose to alter the approach and combine or break out sections of work. This is acceptable provided that the appropriate Acts, regulations, guidelines, standards and codes are followed and afford protection for the health and safety of workers, occupants and the public that is at least equal to the protection that would be provided by complying with the minimum requirements.  
3) All waste generated is subject to characterization and disposal in accordance with Ontario Regulation 347.

Table 1 and 2 - Damaged Materials - Waterloo Oxford District Secondary School

TABLE 3: BULK ASBESTOS SAMPLING SUMMARY					
Sample #	WRDSB Fixed Reference Number	Material Description	Asbestos Content (%)	Fibre Type	Is Material ACM
<b>2008 Asbestos Audit Update</b>					
32523-WOHS S01A	518	Drywall - Joint Compound	ND	-	No
32523-WOHS S01B			ND	-	No
32523-WOHS S01C			ND	-	No
32523-WOHS S02A	518	Plaster - White/Off-White	ND	-	No
32523-WOHS S02B			ND	-	No
32523-WOHS S02C	513		ND	-	No
32523-WOHS S02D			ND	-	No
32523-WOHS S02E		ND	-	No	
32523-WOHS S03A	518	2' x 4' Ceiling Tile	1.7 0.6	Amosite Chrysotile	Yes
32523-WOHS S03B	518		NA	Amosite Chrysotile	Yes
32523-WOHS S03C	518		NA	Amosite Chrysotile	Yes
32523-WOHS S04A	908	1x1 Ceiling Tile - Large and Small Pinhole	ND	-	No
32523-WOHS S04B			ND	-	No
32523-WOHS S04C			ND	-	No
32523-WOHS S05A	513	Plaster - White/Off-White	ND	-	No
32523-WOHS S05B	513		ND	-	No
32523-WOHS S05C	513		ND	-	No
32523-WOHS S05D	513		ND	-	No
32523-WOHS S05E	509		ND	-	No
32523-WOHS S06A	513		Insulation - Fire Spray on beams and columns	4.1	Chrysotile
32523-WOHS S06B		NA		Chrysotile	Yes
32523-WOHS S06C		NA		Chrysotile	Yes
32523-WOHS S07A	516	Drywall - Joint Compound	1.8	Chrysotile	Yes
32523-WOHS S07B			1.7	Chrysotile	Yes
32523-WOHS S07C			1.8	Chrysotile	Yes
32523-WOHS S08A	516	Ceiling Finish - Texture Coat on Columns	ND	-	No
32523-WOHS S08B			ND	-	No
32523-WOHS S08C			ND	-	No
32523-WOHS S09A	515	9"x9" Floor Tile - Brown with White Fleck	Layer 1: 1.3 Layer 2: ND	Chrysotile	Yes
32523-WOHS S09B			Layer 1: NA Layer 2: ND	Chrysotile	Yes
32523-WOHS S09C			Layer 1: NA Layer 2: ND	Chrysotile	Yes
32523-WOHS S10A	509	1x1 Ceiling Tile - Large Pinhole	ND	-	No
32523-WOHS S10B			ND	-	No
32523-WOHS S10C			ND	-	No
32523-WOHS S11A	509	1x1 Ceiling Tile - Long Fissure Small Pinhole	ND	-	No
32523-WOHS S11B			ND	-	No
32523-WOHS S11C			ND	-	No
32523-WOHS S12A	516	1x1 Ceiling Tile - Medium and Small Pinhole	2.1	Amosite	Yes
32523-WOHS S12B			NA	Amosite	No
32523-WOHS S12C			NA	Amosite	No
32523-WOHS S13A	514A	2x4 Ceiling Tile - Random Fissure Random Pinhole	ND	-	No
32523-WOHS S13B			ND	-	No
32523-WOHS S13C			ND	-	No
32523-WOHS S14A	514A FE	1x1 Ceiling Tile - Acoustic Tile	ND	-	No
32523-WOHS S14B			ND	-	No
32523-WOHS S14C			ND	-	No
32523-WOHS S15A	514B – Staff Room	12"x12" Floor Tile - Tan with Brown	Layer 1: 3.6 Layer 2: ND	Chrysotile	Yes
32523-WOHS S15B			Layer 1: NA Layer 2: ND	Chrysotile	Yes
32523-WOHS S15C			Layer 1: NA Layer 2: ND	Chrysotile	Yes
32523-WOHS S16A	514B – Lunch Room	12"x12" Floor Tile - Tan with Grey/Brown Specks	ND	-	No
32523-WOHS S16B			ND	-	No
32523-WOHS S16C			ND	-	No
32523-WOHS S17A	512	2x4 Ceiling Tile - Long Fissure Random Pinhole	ND	-	No
32523-WOHS S17B			ND	-	No
32523-WOHS S17C			ND	-	No

Table 3 - Sample Summary Table - Waterloo Oxford District Secondary School



TABLE 3: BULK ASBESTOS SAMPLING SUMMARY					
Sample #	WRDSB Fixed Reference Number	Material Description	Asbestos Content (%)	Fibre Type	Is Material ACM
32523-WOHS S18A	512	9"x9" Floor Tile - Grey with White/Black	Layer 1: 1.8 Layer 2: ND	Chrysotile -	Yes -
32523-WOHS S18B			Layer 1: NA Layer 2: ND	Chrysotile -	Yes -
32523-WOHS S18C			Layer 1: NA Layer 2: ND	Chrysotile -	Yes -
32523-WOHS S19A	513	Plaster - White with Tan Texture	ND	-	No
32523-WOHS S19B			ND	-	No
32523-WOHS S19C			ND	-	No
32523-WOHS S19D			ND	-	No
32523-WOHS S19E			ND	-	No
32523-WOHS S19F	801		ND	-	No
32523-WOHS S19G			ND	-	No
32523-WOHS S20A	506	9"x9" Floor Tile - Blue with White Streaks	Layer 1: 0.5 Layer 2: ND	Chrysotile -	Yes -
32523-WOHS S20B			Layer 1: NA Layer 2: ND	Chrysotile -	Yes -
32523-WOHS S20C			Layer 1: NA Layer 2: ND	Chrysotile -	Yes -
32523-WOHS S21A	507	9"x9" Floor Tile - Green with White Streak	0.5	Chrysotile	Yes
32523-WOHS S21B			NA	Chrysotile	Yes
32523-WOHS S21C			NA	Chrysotile	Yes
32523-WOHS S22A	801	Insulation - Fire Spray on beams and columns	5.0	Chrysotile	Yes
32523-WOHS S22B			NA	Chrysotile	Yes
32523-WOHS S22C			NA	Chrysotile	Yes
32523-WOHS S23A	812	Insulation - Fire Spray on beams and columns	3.2	Chrysotile	Yes
32523-WOHS S23B			NA	Chrysotile	Yes
32523-WOHS S23C			NA	Chrysotile	Yes
32523-WOHS S24A	812	Plaster - White/Tan	ND	-	No
32523-WOHS S24B			ND	-	No
32523-WOHS S24C			ND	-	No
32523-WOHS S24D			ND	-	No
32523-WOHS S24E			ND	-	No
32523-WOHS S25A	405	9"x9" Floor Tile - Beige with Grey Fleck	Layer 1: Trace Layer 2: ND	Chrysotile -	Yes -
32523-WOHS S25B			Layer 1: Trace Layer 2: ND	Chrysotile -	Yes -
32523-WOHS S25C			Layer 1: Trace Layer 2: ND	Chrysotile -	Yes -
32523-WOHS S26A	404	9"x9" Floor Tile - Tan with White/Black Fleck	Layer 1: 0.75 Layer 2: ND	Chrysotile -	Yes -
32523-WOHS S26B			Layer 1: NA Layer 2: ND	Chrysotile -	Yes -
32523-WOHS S26C			Layer 1: NA Layer 2: ND	Chrysotile -	Yes -
32523-WOHS S27A	505-501	Plaster - White/Tan	ND	-	No
32523-WOHS S27B			ND	-	No
32523-WOHS S27C			ND	-	No
32523-WOHS S27D			ND	-	No
32523-WOHS S27E			ND	-	No
32523-WOHS S28A	501	9"x9" Floor Tile - Grey with White/Black/Red Fleck	Layer 1: 4.1 Layer 2: 1.9	Chrysotile Chrysotile	Yes -
32523-WOHS S28B			Layer 1: NA Layer 2: NA	Chrysotile Chrysotile	Yes -
32523-WOHS S28C			Layer 1: NA Layer 2: NA	Chrysotile Chrysotile	Yes -
32523-WOHS S29A	Stage Entrance	2x2 Ceiling Tile Deep Fissure Small Pinhole	ND	-	No
32523-WOHS S29B			ND	-	No
32523-WOHS S29C			ND	-	No
32523-WOHS S30A	Stage Entrance	12"x12" Floor Tile - Orange with White Fleck	Layer 1: 5.0 Layer 2: ND	Chrysotile -	Yes -
32523-WOHS S30B			Layer 1: NA Layer 2: ND	Chrysotile -	Yes -
32523-WOHS S30C			Layer 1: NA Layer 2: ND	Chrysotile -	Yes -
32523-WOHS S31A	Stage Entrance	12"x12" Floor Tile - Beige with Grey Fleck	ND	-	No
32523-WOHS S31B			ND	-	No
32523-WOHS S31C			ND	-	No

Table 3 - Sample Summary Table - Waterloo Oxford District Secondary School

TABLE 3: BULK ASBESTOS SAMPLING SUMMARY					
Sample #	WRDSB Fixed Reference Number	Material Description	Asbestos Content (%)	Fibre Type	Is Material ACM
32523-WOHS S32A	Cafeteria	12"x12" Floor Tile - Dark Beige with Brown/White Fleck	Layer 1: 0.25	Chrysotile	Yes
32523-WOHS S32B			Layer 2: 3.3	Chrysotile	Yes
32523-WOHS S32C			Layer 1: 0.5	Chrysotile	Yes
			Layer 2: NA	Chrysotile	Yes
32523-WOHS S33A	Cafeteria	Transite - Boards Cat Walk	Layer 1: NA	Chrysotile	Yes
32523-WOHS S33B			Layer 2: NA	Chrysotile	Yes
32523-WOHS S33C			35	Chrysotile	Yes
32523-WOHS S34A	Dressing Room	12"x12" Floor Tile - Green wih Black/White/Grey Fleck	NA	Chrysotile	Yes
32523-WOHS S34B			NA	Chrysotile	Yes
32523-WOHS S34C			Layer 1: 2.2	Chrysotile	Yes
			Layer 2: ND	-	-
32523-WOHS S35A	905	Plaster	Layer 1: NA	Chrysotile	Yes
32523-WOHS S35B			Layer 2: ND	-	-
32523-WOHS S35C			Layer 1: NA	Chrysotile	Yes
32523-WOHS S35D			Layer 2: ND	-	-
32523-WOHS S35E			ND	-	No
32523-WOHS S36A	Cafeteria Hall	2' x 2' Ceiling Tile - Thin Fissure Small Pinhole	ND	-	No
32523-WOHS S36B			Sample not received	-	No
32523-WOHS S36C			Sample not received	-	No
32523-WOHS S37A	Boys Washroom (near 502)	12"x12" Floor Tile - Grey with Brown/White Fleck	ND	-	No
32523-WOHS S37B			ND	-	No
32523-WOHS S37C			ND	-	No
32523-WOHS S38A	Servery	2' x 2' Ceiling Tile - Solid Pattern	ND	-	No
32523-WOHS S38B			ND	-	No
32523-WOHS S38C			ND	-	No
32523-WOHS S39A	Back Storage	Ceiling Finish - Texture Coat/Fire Spray on Steel Deck Only	20	Chrysotile	Yes
32523-WOHS S39B			NA	Chrysotile	Yes
32523-WOHS S39C			NA	Chrysotile	Yes
32523-WOHS S40A	Back Storage	12"x12" Floor Tile - Beige with Light Brown/White Fleck	1.3	Chrysotile	Yes
32523-WOHS S40B			NA	Chrysotile	Yes
32523-WOHS S40C			NA	Chrysotile	Yes
32523-WOHS S41A	Staff Dining	Plaster - White	ND	-	No
32523-WOHS S41B			ND	-	No
32523-WOHS S41C			ND	-	No
32523-WOHS S42A	306	12"x12" Floor Tile - White with Black Fleck	ND	-	No
32523-WOHS S42B			ND	-	No
32523-WOHS S42C			ND	-	No
32523-WOHS S43A	307	Plaster - White/Grey	ND	-	No
32523-WOHS S43B			ND	-	No
32523-WOHS S43C			ND	-	No
32523-WOHS S44A	540	12"x12" Floor Tile - Olive with White Streaks	2.4	Chrysotile	Yes
32523-WOHS S44B			NA	Chrysotile	Yes
32523-WOHS S44C			NA	Chrysotile	Yes
32523-WOHS S45A	540	1' x 1' Ceiling Tile - Thick Fissure Small Pinhole	ND	-	No
32523-WOHS S45B			ND	-	No
32523-WOHS S45C			ND	-	No
32523-WOHS S46A	537	12"x12" Floor Tile - Tan/Olive with White/Brown Specks	1.8	Chrysotile	Yes
32523-WOHS S46B			NA	Chrysotile	Yes
32523-WOHS S46C			NA	Chrysotile	Yes
32523-WOHS S47A	Kiln Room	Refractory - Inside of Kiln	ND	-	No
32523-WOHS S47B			ND	-	No
32523-WOHS S47C			ND	-	No
32523-WOHS S48A	536	9"x9" Floor Tile - Light Brown with Brown/White Fleck	1.2	Chrysotile	Yes
32523-WOHS S48B			Trace	Chrysotile	Yes
32523-WOHS S48C			ND	Chrysotile	Yes
32523-WOHS S49A	534	9"x9" Floor Tile - Dark Green with Green/White Fleck	0.75	Chrysotile	Yes
32523-WOHS S49B			NA	Chrysotile	Yes
32523-WOHS S49C			NA	Chrysotile	Yes
32523-WOHS S50A	534	2' x 4' Ceiling Tile - Dense Small Fissure Random Pinhole	ND	-	No
32523-WOHS S50B			ND	-	No
32523-WOHS S50C			ND	-	No
32523-WOHS S51A	Office (Near 534)	9"x9" Floor Tile - Grey/Tan with White Streaks	1.4	Chrysotile	Yes
32523-WOHS S51B			NA	Chrysotile	Yes
32523-WOHS S51C			NA	Chrysotile	Yes

Table 3 - Sample Summary Table - Waterloo Oxford District Secondary School

TABLE 3: BULK ASBESTOS SAMPLING SUMMARY					
Sample #	WRDSB Fixed Reference Number	Material Description	Asbestos Content (%)	Fibre Type	Is Material ACM
32523-WOHS S52A	527	9"x9" Floor Tile - Dark Grey/Brown with Brown and White Fleck	1.2	Chrysotile	Yes
32523-WOHS S52B			NA	Chrysotile	Yes
32523-WOHS S52C			NA	Chrysotile	Yes
32523-WOHS S53A	530	12"x12" Floor Tile - Brown with White/Brown Spots	ND	-	No
32523-WOHS S53B			ND	-	No
32523-WOHS S53C			ND	-	No
32523-WOHS S54A	823	2' x 4' Ceiling Tile - Textured Pinhole	ND	-	No
32523-WOHS S54B			ND	-	No
32523-WOHS S54C			ND	-	No
32523-WOHS S55A	526	9"x9" Floor Tile - Red/Brown with White/Brown Streaks	1.4	Chrysotile	Yes
32523-WOHS S55B			NA	Chrysotile	Yes
32523-WOHS S55C			NA	Chrysotile	Yes
32523-WOHS S56A	524	9"x9" Floor Tile - Olive/Green/Grey with White Streaks	Layer 1: 0.75 Layer 2: ND	Chrysotile -	Yes No
32523-WOHS S56B			Layer 1: NA Layer 2: ND	Chrysotile -	Yes No
32523-WOHS S56C			Layer 1: NA Layer 2: ND	Chrysotile -	Yes No
32523-WOHS S57A	Girl's Washroom (Near 522)	12"x12" Floor Tile - Beige with Beige Fleck	ND	-	No
32523-WOHS S57B			ND	-	No
32523-WOHS S57C			ND	-	No
32523-WOHS S58A	Custodial (Near 522)	12"x12" Floor Tile - Grey with Grey/White Spots	Layer 1: ND	-	No
32523-WOHS S58B			Layer 1: ND Layer 2: 1.2	- Chrysotile	No Yes
32523-WOHS S58C			Layer 1: ND	-	No
32523-WOHS S59A	Hall Near Fan Room	9"x9" Floor Tile - Grey with White/Grey Streaks	1.5	Chrysotile	Yes
32523-WOHS S59B			NA	Chrysotile	Yes
32523-WOHS S59C			NA	Chrysotile	Yes
32523-WOHS S60A	Mechanical Room	Plaster - Grey	ND	-	No
32523-WOHS S60B			ND	-	No
32523-WOHS S60C			ND	-	No
32523-WOHS S61A	Duct Space	Drywall - Joint Compound	1.3	Chrysotile	Yes
32523-WOHS S61B			NA	Chrysotile	Yes
32523-WOHS S61C			NA	Chrysotile	Yes
32523-WOHS S62A	Duct Space	Ceiling Finish - Fire Spray/Texture Coat Old Exterior	ND	-	No
32523-WOHS S62B			ND	-	No
32523-WOHS S62C			ND	-	No
32523-WOHS S63A	Weight Room	Drywall - Joint Compound	ND	-	No
32523-WOHS S63B			ND	-	No
32523-WOHS S63C			ND	-	No
32523-WOHS S64A	Hallways Between Gyms	Plaster - White/Grey	ND	-	No
32523-WOHS S64B			ND	-	No
32523-WOHS S64C			ND	-	No
32523-WOHS S64D	808		ND	-	No
32523-WOHS S64E			ND	-	No
32523-WOHS S65A			ND	-	No
32523-WOHS S65B	Phys-Ed Office	2' x 4' Ceiling Tile - Thick Fissure	ND	-	No
32523-WOHS S65C			ND	-	No
32523-WOHS S66A			ND	-	No
32523-WOHS S66B	808	12"x12" Floor Tile - Black with Grey/White Streaks	ND	-	No
32523-WOHS S66C			ND	-	No
32523-WOHS S67A			ND	-	No
32523-WOHS S67B	808	12"x12" Floor Tile - Grey with Grey/White Streaks	ND	-	No
32523-WOHS S67C			ND	-	No
32523-WOHS S68A			Tuck Shop	9"x9" Floor Tile - Dark Grey with White Streaks	Layer 1: 1.3 Layer 2: 3.5
32523-WOHS S68B	Layer 1: NA Layer 2: NA	Chrysotile Chrysotile			Yes Yes
32523-WOHS S68C	Layer 1: NA Layer 2: NA	Chrysotile Chrysotile			Yes Yes
32523-WOHS S69A	Boiler Room	Pipe Insulation - Boiler Breechings			5 65
32523-WOHS S69B			NA	Amosite Chrysotile	Yes Yes
32523-WOHS S69C			NA	Amosite Chrysotile	Yes Yes
32523-WOHS S70A	Boiler Room	Pipe Insulation - Mag Block	85	Amosite	Yes
32523-WOHS S70B			NA	Amosite	Yes
32523-WOHS S70C			NA	Amosite	Yes

Table 3 - Sample Summary Table - Waterloo Oxford District Secondary School

TABLE 3: BULK ASBESTOS SAMPLING SUMMARY						
Sample #	WRDSB Fixed Reference Number	Material Description	Asbestos Content (%)	Fibre Type	Is Material ACM	
32523-WOHS S71A	801	Insulation - Fire Spray Beams and Columns	3.8	Chrysotile	Yes	
32523-WOHS S71B			NA	Chrysotile	Yes	
32523-WOHS S71C			NA	Chrysotile	Yes	
32523-WOHS S72A	801	Plaster - White/Grey	ND	-	No	
32523-WOHS S72B			ND	-	No	
32523-WOHS S72C			ND	-	No	
32523-WOHS S72D	125	Plaster - White/Grey	ND	-	No	
32523-WOHS S72E			ND	-	No	
32523-WOHS S73A			ND	-	No	
32523-WOHS S73B	CU Lunch Room	Drywall - Joint Compound	ND	-	No	
32523-WOHS S73C			ND	-	No	
32523-WOHS S74A	Men's Washroom	Vinyl Sheet Flooring - Beige with Pebble	10	Chrysotile	Yes	
32523-WOHS S74B			NA	Chrysotile	Yes	
32523-WOHS S74C			NA	Chrysotile	Yes	
32523-WOHS S75A	127	9"x9" Floor Tile - Beige with Brown/White Fleck	1.5	Chrysotile	Yes	
32523-WOHS S75B			NA	Chrysotile	Yes	
32523-WOHS S75C			NA	Chrysotile	Yes	
32523-WOHS S76A	125	9"x9" Floor Tile - Green with Faded Streak	1.4	Chrysotile	Yes	
32523-WOHS S76B			NA	Chrysotile	Yes	
32523-WOHS S76C			NA	Chrysotile	Yes	
32523-WOHS S77A	208	1' x 1' Ceiling Tile - Large and Small Pinhole	ND	-	No	
32523-WOHS S77B	206		ND	-	No	
32523-WOHS S78A	208		2' x 4' Ceiling Tile - Short Fissure Random Pinhole	ND	-	No
32523-WOHS S78B	206	ND		-	No	
32523-WOHS S79A	208	Insulation - Paper Backing	ND	-	No	
32523-WOHS S79B			ND	-	No	
32523-WOHS S79C			ND	-	No	
32523-WOHS S80A	208	12"x12" Floor Tile - Green	ND	-	No	
32523-WOHS S80B			ND	-	No	
32523-WOHS S80C			ND	-	No	
32523-WOHS S81A	208	Drywall - Joint Compound	ND	-	No	
32523-WOHS S81B	Work Room (Between 202 and 204)		ND	-	No	
32523-WOHS S81C	207	Drywall - Joint Compound	1.0	Chrysotile	Yes	
32523-WOHS S81D	205		NA	Chrysotile	Yes	
32523-WOHS S81E	NA		Chrysotile	Yes		
32523-WOHS S81F	802	Drywall - Joint Compound	NA	-	No	
32523-WOHS S81G	Library		NA	-	No	
32523-WOHS S82A	206	Plaster - White/Grey	Layer 1: NA Layer 2: NA	-	No	
32523-WOHS S82B	204		Layer 1: NA Layer 2: NA	-	No	
32523-WOHS S82C	207A		Layer 1: NA Layer 2: NA	-	No	
32523-WOHS S82D	207		Layer 1: NA Layer 2: NA	-	No	
32523-WOHS S82E	207A		Layer 1: NA Layer 2: NA	-	No	
32523-WOHS S82F	802		Layer 1: NA Layer 2: NA	-	No	
32523-WOHS S82G	302/303		Layer 1: NA Layer 2: NA	-	No	
32523-WOHS S83A	202		1' x 1' Ceiling Tile - Wide Fissure Random Pinhole	ND	-	No
32523-WOHS S83B				ND	-	No
32523-WOHS S84A	202	12"x12" Floor Tile - Taupe	2.2	Chrysotile	Yes	
32523-WOHS S84B			NA	Chrysotile	Yes	
32523-WOHS S84C			NA	Chrysotile	Yes	
32523-WOHS S85A	Work Room (Between 204 and 204)	2' x 4' Ceiling Tile - Long Fissure Random Pinhole	ND	-	No	
32523-WOHS S85B			ND	-	No	
32523-WOHS S85C			ND	-	No	
32523-WOHS S86A	Science Office (Between 204 and 204)	2' x 4' Ceiling Tile - Random Fissure Random Pinhole	ND	-	No	
32523-WOHS S86B			ND	-	No	
32523-WOHS S86C			ND	-	No	
32523-WOHS S87A	207	1' x 1' Ceiling Tile - Crater with Dots	ND	-	No	
32523-WOHS S87B			ND	-	No	
32523-WOHS S87C			ND	-	No	

Table 3 - Sample Summary Table - Waterloo Oxford District Secondary School

TABLE 3: BULK ASBESTOS SAMPLING SUMMARY					
Sample #	WRDSB Fixed Reference Number	Material Description	Asbestos Content (%)	Fibre Type	Is Material ACM
32523-WOHS S88A	207	12"x12" Floor Tile - Grey/Green	Layer 1: 2.7	Chrysotile	Yes
32523-WOHS S88B			Layer 1: NA	Chrysotile	Yes
32523-WOHS S88C			Layer 2: 0.75%	Chrysotile	Yes
32523-WOHS S89A	201	9x9 Vinyl Floor Tile - Grey with Black	Layer 1: NA	Chrysotile	Yes
32523-WOHS S89B			Layer 2: NA	Chrysotile	Yes
32523-WOHS S89C			2.4	Chrysotile	Yes
32523-WOHS S90A	Staff Room	12x12 Vinyl Floor Tile - Grey Oatmeal	NA	Chrysotile	Yes
32523-WOHS S90B			NA	Chrysotile	Yes
32523-WOHS S90C			ND	-	No
32523-WOHS S91A	Health Hallway	12x12 Vinyl Floor Tile - Grey with Spots	ND	-	No
32523-WOHS S91B			ND	-	No
32523-WOHS S91C			ND	-	No
32523-WOHS S92A	Library Hallway	2x2 Ceiling Tile - Short Fissure Random Pinhole	ND	-	No
32523-WOHS S92B			ND	-	No
32523-WOHS S92C			ND	-	No
32523-WOHS S93A	302	2x2 Ceiling Tile - Meal Worm	ND	-	No
32523-WOHS S93B			ND	-	No
32523-WOHS S93C			ND	-	No
32523-WOHS S94A	302	12x12 Vinyl Floor Tile - Cream with Brown	ND	-	No
32523-WOHS S94B			ND	-	No
32523-WOHS S94C			ND	-	No
32523-WOHS S95A	PED	12x12 Vinyl Floor Tile - Brown Oatmeal	Layer 1: 0.75	Chrysotile	Yes
32523-WOHS S95B			Layer 2: ND	-	No
32523-WOHS S95C			Layer 1: NA	Chrysotile	Yes
32523-WOHS S96A	Conference Room	9x9 Vinyl Floor Tile - Taupe with Spots	Layer 2: ND	-	No
32523-WOHS S96B			Layer 1: NA	Chrysotile	Yes
32523-WOHS S96C			Layer 2: ND	-	No
32523-WOHS S97A	Exterior	Ceiling Finish - Exterior Texture Coat	Layer 1: NA	Chrysotile	Yes
32523-WOHS S97B			Layer 2: ND	-	No
32523-WOHS S97C			ND	-	No
32523-WOHS S98A	-	Ceiling Finish - Texture Coat	ND	-	No
32523-WOHS S98B			ND	-	No
32523-WOHS S98C			ND	-	No
<b>Additional Sampling (August 2010)</b>					
34152-200-S01A	Corridor (Stairwell 902)	Drywall Skim Coat	ND	-	No
34152-200-S01B			ND	-	No
34152-200-S01C			ND	-	No
34152-200-S02A	Adjacent to Teacher Common Room	Firespray Overspray - On Ducts	1	Actinolite	Yes
34152-200-S02B			15	Chrysotile	Yes
34152-200-S02C			NA	Actinolite	Yes
34152-200-S03A	Corridor Adjacent to Room 502	Drywall Glue/Puddy	NA	Chrysotile	Yes
34152-200-S03B			ND	-	No
34152-200-S03C			ND	-	No
34152-200-S04A	Boiler Room	Plaster	ND	-	No
34152-200-S04B			ND	-	No
34152-200-S04C			ND	-	No
34152-200-S05A	Exterior (Stairwell 909)	Caulking - Grey	ND	-	No
34152-200-S05B			ND	-	No
34152-200-S05C			ND	-	No
34152-200-S06A	Exterior (Stairwell 909)	Caulking - White	ND	-	No
34152-200-S06B			ND	-	No
34152-200-S06C			ND	-	No
<b>Additional Sampling (November 2010)</b>					
34152-200-S01A	-	Vermiculite - Insulation	ND	-	No
34152-200-S01B	-		ND	-	No
34152-200-S01C	-		ND	-	No
34152-200-S01A-C	-	Vermiculite	Chatfield Analysis - ND	-	No

Table 3 - Sample Summary Table - Waterloo Oxford District Secondary School

TABLE 3: BULK ASBESTOS SAMPLING SUMMARY					
Sample #	WRDSB Fixed Reference Number	Material Description	Asbestos Content (%)	Fibre Type	Is Material ACM
<b>2011 Asbestos Audit Update</b>					
BR-LC- Plaster-S01a	Boiler Room	Lower Ceiling Plaster	ND	-	No
BR-LC- Plaster-S01b			ND	-	No
BR-LC- Plaster-S01c			ND	-	No
BR-UC- Plaster-S02a	Boiler Room	Upper Ceiling Plaster	ND	-	No
BR-UC- Plaster-S02b			ND	-	No
BR-UC- Plaster-S02c			ND	-	No
<b>Additional Sampling (2013)</b>					
WODSS –S01A	Collected by WRDSB	2'x2' Ceiling Tile	ND	-	No
WODSS –S01B			ND	-	No
WODSS –S01C			ND	-	No
<b>Additional Sampling (July 11, 2016)</b>					
S01A	-	Texture Coat on Canopy	ND	-	No
S01B	-	Texture Coat on Canopy	ND	-	No
S01C	-	Texture Coat on Canopy	ND	-	No
<b>Additional Sampling (November 3, 2017)</b>					
S01A	535	1'x1' Medium Pinhole Ceiling Tiles	ND	-	No
S01B	535	1'x1' Medium Pinhole Ceiling Tiles	ND	-	No
S01C	535	1'x1' Medium Pinhole Ceiling Tiles	ND	-	No
<b>Additional Sampling (April 9, 2018)</b>					
S01A	811	Ceiling Tiles - Random Fissure Pattern	ND	-	No
S01B	811	Ceiling Tiles - Random Fissure Pattern	ND	-	No
S01C	811	Ceiling Tiles - Random Fissure Pattern	ND	-	No
S02A	811	Ceiling Tiles - Small Fissure Pattern	ND	-	No
S02B	811	Ceiling Tiles - Small Fissure Pattern	ND	-	No
S02C	811	Ceiling Tiles - Small Fissure Pattern	ND	-	No
<b>2018 Asbestos Audit Update</b>					
S01A	403B	2'x4' Small Fissure Small Pinhole Ceiling Tile	ND	-	No
S01B	403B	2'x4' Small Fissure Small Pinhole Ceiling Tile	ND	-	No
S01C	403B	2'x4' Small Fissure Small Pinhole Ceiling Tile	ND	-	No
S02A	513A	2'x4' Medium Fissure Random Pinhole Ceiling Tile	ND	-	No
S02B	513A	2'x4' Medium Fissure Random Pinhole Ceiling Tile	ND	-	No
S02C	513A	2'x4' Medium Fissure Random Pinhole Ceiling Tile	ND	-	No
S03A	512B	Plaster - 1962 Addition	ND	-	No
S03B	510	Plaster - 1962 Addition	ND	-	No
S03C	510	Plaster - 1962 Addition	ND	-	No
S04A	512C	1'x1' B/S PH Ceiling Tile - Brown Mastic	ND	-	No
S04B	512C	1'x1' B/S PH Ceiling Tile - Brown Mastic	ND	-	No
S04C	512C	1'x1' B/S PH Ceiling Tile - Brown Mastic	ND	-	No
<b>S05A</b>	<b>809</b>	<b>2'x2' Dense Fissure Random Pinhole Ceiling Tile</b>	<b>5</b>	<b>Amosite</b>	<b>Yes</b>
<b>S05B</b>	<b>809</b>	<b>2'x2' Dense Fissure Random Pinhole Ceiling Tile</b>	<b>NA</b>	<b>Amosite</b>	<b>Yes</b>
<b>S05C</b>	<b>809</b>	<b>2'x2' Dense Fissure Random Pinhole Ceiling Tile</b>	<b>NA</b>	<b>Amosite</b>	<b>Yes</b>
S06A	809	2'x2' Medium Fissure Pinhole Ceiling Tile	ND	-	No
S06B	809	2'x2' Medium Fissure Pinhole Ceiling Tile	ND	-	No
S06C	809	2'x2' Medium Fissure Pinhole Ceiling Tile	ND	-	No
S07A	305	12"x12" Teal Dense Fleck Floor Tile	ND	-	No
S07B	305	12"x12" Teal Dense Fleck Floor Tile	ND	-	No
S07C	305	12"x12" Teal Dense Fleck Floor Tile	ND	-	No
S08A	207A	1'x1' Texture Fissure Pinhole Ceiling Tile	ND	-	No
S08B	207A	1'x1' Texture Fissure Pinhole Ceiling Tile	ND	-	No
S08C	207A	1'x1' Texture Fissure Pinhole Ceiling Tile	ND	-	No
<b>S09A</b>	<b>104</b>	<b>9"x9" Olive with White Streak Floor Tile</b>	<b>2</b>	<b>Chrysotile</b>	<b>Yes</b>
<b>S09B</b>	<b>104</b>	<b>9"x9" Olive with White Streak Floor Tile</b>	<b>NA</b>	<b>Chrysotile</b>	<b>Yes</b>
<b>S09C</b>	<b>104</b>	<b>9"x9" Olive with White Streak Floor Tile</b>	<b>NA</b>	<b>Chrysotile</b>	<b>Yes</b>
S10A	400B	2'x4' Texture Pinhole Ceiling Tile	ND	-	No
S10B	400B	2'x4' Texture Pinhole Ceiling Tile	ND	-	No
S10C	400B	2'x4' Texture Pinhole Ceiling Tile	ND	-	No
<b>S11A</b>	<b>122</b>	<b>9"x9" Olive w Black Streak Vinyl Floor Tiles</b>	<b>1</b>	<b>Chrysotile</b>	<b>Yes</b>
<b>S11B</b>	<b>122</b>	<b>9"x9" Olive w Black Streak Vinyl Floor Tiles</b>	<b>NA</b>	<b>Chrysotile</b>	<b>Yes</b>
<b>S11C</b>	<b>122</b>	<b>9"x9" Olive w Black Streak Vinyl Floor Tiles</b>	<b>NA</b>	<b>Chrysotile</b>	<b>Yes</b>
S12A	522	1'x1' Large/Medium Pinhole Cellulose Ceiling Tile Brown Mastic	ND	-	No
S12B	522	1'x1' Large/Medium Pinhole Cellulose Ceiling Tile Brown Mastic	ND	-	No

Table 3 - Sample Summary Table - Waterloo Oxford District Secondary School

<b>TABLE 3: BULK ASBESTOS SAMPLING SUMMARY</b>					
<b>Sample #</b>	<b>WRDSB Fixed Reference Number</b>	<b>Material Description</b>	<b>Asbestos Content (%)</b>	<b>Fibre Type</b>	<b>Is Material ACM</b>
S12C	522	1'x1' Large/Medium Pinhole Cellulose Ceiling Tile Brown Mastic	ND	-	No
S13A	530	1'x1' Large/Medium Pinhole Ceiling Tile	ND	-	No
S13B	530	1'x1' Large/Medium Pinhole Ceiling Tile	ND	-	No
S13C	530	1'x1' Large/Medium Pinhole Ceiling Tile	ND	-	No
<b>2018 Asbestos Audit Update, Additional Sampling (October 5, 2018)</b>					
S01A	518	Beige Sealant on Interior Doors (1972)	ND	-	No
S01B	518	Beige Sealant on Interior Doors (1972)	ND	-	No
S01C	518	Beige Sealant on Interior Doors (1972)	ND	-	No
S02A	518	Brown Sealant on Exterior Doors (1972)	8	Chrysotile	Yes
S02B	518	Brown Sealant on Exterior Doors (1972)	NA	Chrysotile	Yes
S02C	518	Brown Sealant on Exterior Doors (1972)	NA	Chrysotile	Yes
S03A	517	Beige Sealant on Interior Window Frames (1972)	8	Chrysotile	Yes
S03B	517	Beige Sealant on Interior Window Frames (1972)	NA	Chrysotile	Yes
S03C	517	Beige Sealant on Interior Window Frames (1972)	NA	Chrysotile	Yes
S04A	824	Beige Sealant on Interior Window Frames (1962)	1	Chrysotile	Yes
S04B	824	Beige Sealant on Interior Window Frames (1962)	NA	Chrysotile	Yes
S04C	824	Beige Sealant on Interior Window Frames (1962)	NA	Chrysotile	Yes
S05A	1009	Beige Sealant on Interior Window Frames (1966)	5	Chrysotile	Yes
S05B	1009	Beige Sealant on Interior Window Frames (1966)	NA	Chrysotile	Yes
S05C	1009	Beige Sealant on Interior Window Frames (1966)	NA	Chrysotile	Yes
<b>2022 Additional Sampling (October 3, 2022)</b>					
S01A	102A	Trowel Applied Fireproofing	40	Chrysotile	Yes
S01B	102A	Trowel Applied Fireproofing	NA	Chrysotile	Yes
S01C	102A	Trowel Applied Fireproofing	NA	Chrysotile	Yes
<p><b>NA:</b> Not Analyzed due to stop positive method <b>ND:</b> No asbestos fibres detected above the laboratory minimum detection limit</p> <p>A bulk material sample containing 0.5% or more asbestos therefore establishes that material as asbestos-containing. In accordance with Table 1 of O. Reg. 278/05, a minimum number of samples for the material to be classified as non asbestos. A homogeneous material is defined by O. Reg. 278/05 "as material that is uniform in colour and texture". Homogeneous samples are identified by an alphabetical suffix to sample names to represent multiple samples of a homogeneous material. When a homogeneous material is analysed it is determined to be asbestos-containing upon the first positive detection of asbestos equal to or greater than 0.5%. Subsequent samples of the same material are therefore not analysed. Some bulk samples are comprised of multiple layers and as such will require multiple analysis. In such cases each layer is isolated at the laboratory and analysed individually to determine asbestos content. As a result the laboratory may report additional samples beyond the submitted number of samples or include multiple analyses as subsets within a sample.</p>					

Table 3 - Sample Summary Table - Waterloo Oxford District Secondary School

## Certificate of Analysis

**MTE Consultants Inc. (Kitchener)**

520 Bingemans Centre Dr.  
Kitchener, ON N2B 3X9  
Attn: Paul Semeniuk

Client PO: 34532-940

Project: 34532-940 WO-100 Series 2nd Mech

Custody:

Report Date: 13-Oct-2022

Order Date: 6-Oct-2022

**Order #: 2241396**

This Certificate of Analysis contains analytical data applicable to the following samples as submitted :

Parcel ID	Client ID
2241396-01	S01A - Trowel Applied Fire Proofing - Rm 120A
2241396-02	S01B - Trowel Applied Fire Proofing - Rm 120A
2241396-03	S01C - Trowel Applied Fire Proofing - Rm 120A

Approved By:



Emma Diaz

Senior Analyst



Certificate of Analysis  
 Client: MTE Consultants Inc. (Kitchener)  
 Client PO: 34532-940

Report Date: 13-Oct-2022  
 Order Date: 6-Oct-2022

Project Description: 34532-940 WO-100 Series 2nd Mech

**Asbestos, PLM Visual Estimation    \*\*MDL - 0.5%\*\***

Parcel ID	Sample Date	Colour	Description	Asbestos Detected	Material Identification	% Content
2241396-01	03-Oct-22	Grey	Fireproofing	<b>Yes</b>	<b>Client ID: S01A - Trowel Applied Fire Proofing - Rm 120A</b> Chrysotile Non-Fibers	<b>[Z-01]</b> 40 60
2241396-02	03-Oct-22	Grey	Fireproofing		<b>Client ID: S01B - Trowel Applied Fire Proofing - Rm 120A</b> not analyzed, positive stop	<b>[Z-01]</b>
2241396-03	03-Oct-22	Grey	Fireproofing		<b>Client ID: S01C - Trowel Applied Fire Proofing - Rm 120A</b> not analyzed, positive stop	<b>[Z-01]</b>

\*\* Analytes in bold indicate asbestos mineral content.

**Analysis Summary Table**

Analysis	Method Reference/Description	Lab Location	Lab Accreditation	Analysis Date
Asbestos, PLM Visual Estimation	AppE to SubE of 40CFR Part753 and EPA/600/R-93/116	1 - Mississauga	CALA 3762	12-Oct-22

Mississauga Lab: 15 - 6800 Kitimat Rd Mississauga, Ontario, L5N 5M1

**Qualifier Notes**

Sample Qualifiers :

Z-01: Sample contains vermiculite.

**Work Order Revisions | Comments**

None

## **01 42 00 – References**

### **1.0 GENERAL**

#### **1.1. SECTION INCLUDES**

- .1 References and standards.
- .2 Standards producing industry organizations and their addresses.

#### **1.2. RELATED SECTIONS**

- .1 Section 01 61 00 – Product Requirements.
- .2 This Section describes requirements applicable to all Sections within Divisions 02 to 49.

#### **1.3. REFERENCES**

- .1 For Products or quality specified by association, trade, or other references or consensus standards, comply with requirements of the standard, except when more rigid requirements are specified or are required by applicable codes.
- .2 Conform to reference standard by Ontario Building Code except where a specific date is established or required by code.
- .3 Obtain copies of standards where required by product specification sections.
- .4 Neither the contractual relationships, duties, or responsibilities of the parties in Contract nor those of the Consultant shall be altered from the Contract Documents by mention or inference otherwise, in any reference document.

#### **1.4. STANDARDS**

- .1 The following associations and organizations are cited in specification sections. Acronym, name, address, and Internet URL addresses are as follows:
- .2 Canadian Organizations:
  - .1 Street, Suite 616, Ottawa, ON K1P 5G4; URL: <http://www.acec.ca>.
  - .2 **AWMAC** - Architectural Woodwork Manufacturers Association of Canada, 516-4 Street West, High River, AB T1V 1B6; URL: <http://www.awmac.com>.
  - .3 **Canada Green Building Council**, 330 - 55 rue Murray Street, Ottawa, ON. K1N5M3; Tel: 613-241-1184, Fax: 613-241-5750; URL: <http://www.cagbc.org>.
  - .4 **CCA** - Canadian Construction Association, 75 Albert St., Suite 400, Ottawa, ON K1P 5E7; URL: <http://www.cca-acc.com>.
  - .5 **CCDC** – Canadian Construction Documents Committee, Refer to ACEC, CCA, CSC or RAIC; URL: <http://www.CCDC.org>.

- 
- .6 **CGA** - Canadian Gas Association, 20 Eglinton Avenue West, Suite 1305, Toronto, ON M4R 1K8; URL: <http://www.cga.ca>.
  - .7 **CGSB** - Canadian General Standards Board, Place du Portage, Phase III, 6B1, 11 Laurier Street, Hull, QC K1A 0S5; URL: <http://w3.pwgsc.gc.ca/cgsb>.
  - .8 **CISC** - Canadian Institute of Steel Construction, 201 Consumers Road, Suite 300, Willowdale, ON M2J 4G8; URL: <http://www.cisc-icca.ca>.
  - .9 **CLA** - Canadian Lumbermen's Association, 27 Goulburn Avenue, Ottawa, ON K1N 8C7; URL: <http://www.cla-ca.ca>.
  - .10 **CNLA** - Canadian Nursery Landscape Association, RR #4, Stn. Main, 7856 Fifth Street, Milton, ON L9T 2X8; URL: <http://www.canadanursery.com>.
  - .11 **CRCA** - Canadian Roofing Contractors Association, 155 Queen Street, Suite 1300, Ottawa, ON K1P 6L1; URL: <http://www.roofingcanada.com>.
  - .12 **CSA** - Canadian Standards Association International, 178 Rexdale Blvd., Toronto, ON M9W 1R3; URL: <http://www.csa-international.org>.
  - .13 **CSC** - Construction Specifications Canada, 120 Carlton Street, Suite 312, Toronto, ON M5A 4K2; URL: <http://www.csc-dcc.ca>.
  - .14 **CSDMA** - Canadian Steel Door Manufacturers Association, One Yonge Street, Suite 1801, Toronto, ON M5E 1W7; URL: <http://www.csdma.org>.
  - .15 **CSPI** - Corrugated Steel Pipe Institute, 652 Bishop Street N, Unit 2A, Cambridge, ON N3H 4V6; URL: <http://www.cspi.ca>.
  - .16 **CSSBI** - Canadian Sheet Steel Building Institute, 652 Bishop St. N., Unit 2A, Cambridge, ON N3H 4V6; URL: <http://www.cssbi.ca>.
  - .17 **CUFCA** - Canadian Urethane Foam Contractor's Association, Box 3214, Winnipeg, MB R3C 4E7; URL: <http://www.cufca.ca>.
  - .18 **CWC** - Canadian Wood Council, 1400 Blair Place, Suite 210, Ottawa, ON. K1J 9B8; URL: <http://www.cwc.ca>.
  - .19 **EC** - Environment Canada, Conservation and Protection, Inquiry Centre, 351 St. Joseph Blvd, Hull, QC KIA 0H3; URL: <http://www.ec.gc.ca>.
  - .20 **EFC** - Electro Federation of Canada, 5800 Explorer Drive, Suite 200, Mississauga, ON L4W 5K9; URL: <http://www.electrofed.com>.
  - .21 **MPI** - The Master Painters Institute, 4090 Graveley Street, Burnaby, BC V5C 3T6; URL: <http://www.paintinfo.com>.
  - .22 **NABA** - National Air Barrier Association, PO Box 2747, Winnipeg, MB R3C 4E7; URL: <http://www.naba.ca>.
  - .23 **NLGA** - National Lumber Grades Authority, 406-First Capital Place, 960 Quayside Drive, New Westminster, BC V3M 6G2; URL: <http://www.nlga.org>.

- 
- .24 **NRC** - National Research Council, Building M-58, 1200 Montreal Road, Ottawa, ON K1A 0R6; URL: <http://www.nrc.gc.ca>.
  - .25 **QPL** - Qualification Program List, c/o Canadian General Standards Board, Place du Portage, Phase III, 6B1, 11 Laurier Street, Hull, QC K1A 1G6; URL: <http://www.pwgsc.gc.ca/cgsb>.
  - .26 **RAIC** - Royal Architectural Institute of Canada, 55 Murray Street, Suite 330, Ottawa, ON K1N 5M3; URL: <http://www.raic.org>.
  - .27 **SCC** - Standards Council of Canada, 270 Albert Street, Suite 2000, Ottawa, ON K1P 6N7; URL: <http://www.scc.ca>.
  - .28 **TTMAC** - Terrazzo, Tile and Marble Association of Canada, 30 Capston Gate, Unit 5 Concord, ON L4K 3E8; URL: <http://www.ttmac.com>.
  - .29 **ULC** - Underwriters' Laboratories of Canada, 7 Crouse Road, Toronto, ON M1R 3A9; URL: <http://www.ulc.ca>.
  - .3 USA Organizations:
    - .1 **AA** - Aluminum Association, 900 19th Street N.W., Washington, DC 20006; URL: <http://www.aluminum.org>.
    - .2 **AASHTO** - American Association of State Highway and Transportation Officials, 444 N Capitol Street N.W., Suite 249, Washington, DC 20001; URL: <http://www.aashto.org>.
    - .3 **AHA** - American Hardboard Association, 1210W Northwest Hwy, Palatine, IL 60067; URL: <http://www.hardboard.org>.
    - .4 **AITC** - American Institute of Timber Construction, 7012 S. Revere Parkway, Suite 140, Englewood, CO 80112; URL: <http://www.aitc-glulam.org>.
    - .5 **AMCA** - Air Movement and Control Association Inc., 30 West University Drive, Arlington Heights, IL 60004-1893; URL: <http://www.amca.org>.
    - .6 **ANSI** - American National Standards Institute, 25 West 43rd Street, 4th Floor, New York, NY 10036; URL: <http://www.ansi.org>.
    - .7 **APA** - The Engineered Wood Association, P.O. Box 11700, Tacoma, WA 98411-0700; URL: <http://www.apawood.org>.
    - .8 **API** - American Petroleum Institute, 1220 L St. Northwest, Washington, DC 20005-4070; URL: <http://www.api.org>.
    - .9 **ARI** - Air Conditioning and Refrigeration Institute, 4100 N Fairfax Drive, Suite 200, Arlington, VA 22203; URL: <http://www.ari.org>.
    - .10 **ASHRAE** - American Society of Heating, Refrigeration and Air-Conditioning Engineers, 1791 Tullie Circle NE, Atlanta, GA 30329; URL: <http://www.ashrae.org>.

- 
- .11 **ASME** - American Society of Mechanical Engineers, ASME Headquarters, 3 Park Avenue, New York, NY 10016-5990; URL: <http://www.asme.org>.
  - .12 **ASTM International**, 100 Barr Harbor Drive West, Conshohocken, PA 19428-2959; URL: <http://www.astm.org>.
  - .13 **AWCI** - Association of the Wall and Ceiling Industries International, 803 West Broad Street, Suite 600 , Falls Church, VA 22046; URL: <http://www.awci.org>.
  - .14 **AWPA** - American Wire Producer's Association, 801 N Fairfax Street, Suite 211, Alexandria, VA 22314-1757; URL: <http://www.awpa.org>.
  - .15 **AWPA** - American Wood Preservers' Association, P.O. Box 5690, Granbury TX 76049-0690; URL: <http://www.awpa.com>
  - .16 **AWS** - American Welding Society, 550 N.W. LeJeune Road, Miami, FL 33126; URL: <http://www.amweld.org>.
  - .17 **AWWA** - American Water Works Association, 6666 W. Quincy Avenue, Denver, CO 80235; URL: <http://www.awwa.org>.
  - .18 **EIMA** - EIFS Industry Manufacturer's Association, 3000 Corporate Center Drive, Suite 270, Morrow, GA 30260; URL: <http://www.eima.com>.
  - .19 **ISAP** - International Society for Asphalt Paving, 400 Selby Avenue, Suite 1, St. Paul, MN 55102; URL: <http://www.asphalt.org>.
  - .20 **IEEE** - Institute of Electrical and Electronics Engineers, IEE Corporate Office, 3 Park Avenue, 17th Floor, New York, NY 10016-5997; URL: <http://www.ieee.org>
  - .21 **MSS** - Manufacturers Standardization Society of the Valve and Fittings Industry, 127 Park Street, N.E., Vienna, VA 22180-4602; URL: <http://www.mss-hq.com>.
  - .22 **NAAMM** - National Association of Architectural Metal Manufacturers, 8 South Michigan Avenue, Suite 1000, Chicago, IL 60603; URL: <http://www.naamm.org>.
  - .23 **NEMA** - National Electrical Manufacturers Association, 1300 N 17th Street, Suite 1847, Rosslyn, VA 22209; URL: <http://www.nema.org>.
  - .24 **NFPA** - National Fire Protection Association, 1 Batterymarch Park, P.O. Box 9101 Quincy, MA 02269-9101; URL: <http://www.nfpa.org>.
  - .25 **NFSA** - National Fire Sprinkler Association, P.O. Box 1000, Patterson, NY 12563; URL: <http://www.nfsa.org>.
  - .26 **NHLA** - National Hardwood Lumber Association, 6830 Raleigh-La Grange Road, Memphis, TN 38184-0518; URL: <http://www.natlhardwood.org>.
  - .27 **NSPE** - National Society of Professional Engineers, 1420 King Street, Alexandria, VA 22314-2794; URL: <http://www.nspe.org>.

- .28 **PCI** - Prestressed Concrete Institute, 209 W. Jackson Blvd., Suite 500, Chicago, IL 60606-6938; URL: <http://www.pci.org>.
- .29 **PEI** - Porcelain Enamel Institute, PO Box 920220, Norcross, GA 30010; URL: <http://www.porecelainenamel.com>.
- .30 **SSPC** - The Society for Protective Coatings, 40 24th Street, 6th Floor, Pittsburgh, PA 15222-4656; URL: <http://www.sspc.org>.
- .31 **TPI** - Truss Plate Institute, 583 D'Onofrio Drive, Suite 200, Madison, WI 53719; URL: <http://www.tpinst.org>.
- .32 **UL** - Underwriters' Laboratories, 333 Pfingsten Road, Northbrook, IL60062-2096; URL: <http://www.ul.com>.

**END OF SECTION**

## **01 45 00 – Quality Control**

### **1.0 GENERAL**

#### **1.1. RELATED SECTIONS**

- .1 Section 01 21 00 - Allowances.
- .2 Section 01 78 10 – Closeout Submittals and Requirements
- .3 Section 01 79 00 – Demonstration and Training
- .4 This Section describes requirements applicable to all Sections within Divisions 02 to 49.

#### **1.2. REFERENCES**

- .1 **ISO/IEC 17025-2005** - General Requirements for the Competence of Testing and Calibration Laboratories.
- .2 **SCC** (Standards Council of Canada).

#### **1.3. INSPECTION BY AUTHORITY**

- .1 Allow Authorities Having Jurisdiction access to Work. If part of Work is in preparation at locations other than Place of Work, allow access to such Work whenever it is in progress.
- .2 Give timely notice requesting inspection whenever portions of the Work are designated for special tests, inspections or approvals, either when described in the Contract Documents or when required by law in the Place of the Work.
- .3 If Contractor covers or permits to be covered Work that has been designated for special tests, inspections or approvals before such is made, uncover such Work, have inspections or tests satisfactorily completed and make good such Work.

#### **1.4. REVIEW BY CONSULTANT**

- .1 Consultant may order any part of the Work to be reviewed or inspected if Work is suspected to be not in accordance with Contract Documents.
- .2 If, upon review such work is found not in accordance with Contract Documents, correct such Work and pay the cost of additional review and correction.
- .3 If such Work is found in accordance with Contract Documents, The owner will pay the cost of review and replacement.

**1.5. INDEPENDENT INSPECTION AGENCIES**

- .1 Independent Inspection and Testing Agencies will be engaged by Contractor for the purpose of inspecting and testing portions of Work.
- .2 The Board may, at their discretion, request that the Consultant direct the Contractor to engage independent inspecting and or testing agencies to review or test the Work.
- .3 Allocate Costs for inspections and testing to Section 01 21 00.
- .4 Provide equipment required for executing inspection and testing by appointed agencies.
- .5 Employment of inspection and testing agencies does not relax responsibility to perform Work in accordance with Contract Documents.
- .6 If defects are revealed during inspection and/or testing, the appointed agency will request additional inspection and testing to ascertain the full degree of defect. Correct defects and irregularities as advised by the Consultant at no cost to the Owner. Contractor shall pay costs directly to the inspection agency for retesting and re-inspection.

**1.6. ACCESS TO WORK**

- .1 Allow inspection and testing agencies access to Work, off site manufacturing and fabrication plants.
- .2 Cooperate to provide reasonable access and facilities for such access.

**1.7. CONTRACTOR RESPONSIBILITIES**

- .1 Notify appropriate agency minimum 48 hours in advance of requirement for tests, in order that attendance arrangements can be made.
- .2 Submit samples and materials required for testing, as specifically requested in specifications. Submit with reasonable promptness and in an orderly sequence so as not to cause delay in Work.
- .3 Provide labour and facilities to obtain and handle samples and materials on site. Provide sufficient space to store and cure test samples.

**1.8. DUTIES & AUTHORITY OF TESTING AGENCY**

- .1 Testing agency is expected to do the following:
  - .1 Act in a professional and unprejudiced basis and carry out inspection and testing functions to establish compliance with requirements of Contract Documents.



- 
- .2 Check work as it progresses and prepare reports stating results of tests and conditions of work and state in each report whether specimens tested conform to requirements of Contract Documents, specifically noting deviations.
  - .3 Distribute reports as follows
    - .1 Consultant
    - .2 Owner
    - .3 Contractor
  - .2 Testing agency is not authorized to amend or release any requirements of Contract Documents, nor to approve or accept any portion of work.

### **1.9. REJECTED WORK**

- .1 The Contractor shall remove defective Work, whether result of poor workmanship, use of defective products or damage and whether incorporated in Work or not, which has been rejected by the Consultant as failing to conform to Contract Documents. Replace or re-execute in accordance with Contract Documents.
- .2 Make good other Contractor's work damaged by such removals or replacements promptly.
- .3 If, it is not expedient to correct defective Work or Work not performed in accordance with Contract Documents, the Owner may choose to accept the condition. The difference in value between Work performed and that called for by Contract Documents shall be deducted from the Contract value via Change Order. The amount of this change shall be determined by the Consultant. The Contractor shall warrant the work performed for the time period specified as if it were performed in accordance with the Contract Documents.

### **1.10. TESTING OF EXCAVATION & BACKFILL**

- .1 The Consultant must approve all Sample and fill tests prior to purchase.
- .2 In coordination with the Consultant and Contractor, inspect and test backfill and fill to ensure the degree of compaction specified has been obtained.
- .3 Inspect excavation at required levels in regard to bearing values for footings, foundations and floor slabs.
- .4 Authorization and calculation of extra excavation work, if required, due to unsatisfactory bearing shall be adjusted by Unit Price.

### **1.11. CONCRETE STRENGTH TESTS**

- .1 Review the proposed concrete mix design and check test if considered necessary.

- .2 Obtain representative samples of fresh concrete for each mix design of concrete placed in any one day as directed by the Consultant.
- .3 Make standard slump tests.
- .4 Mould three (3) standard 150mm diameter cylindrical test specimens from each sampling of fresh concrete. Store specimens as per best practice while they are on the site. Cure all cylinders in the laboratory under standard moisture and temperature conditions. Compression test one of the cylinders at 7 days and the remaining two at 28 days after sampling. Each concrete cylinder test report shall contain the specific location of concrete represented by sample, design strength, aggregate size, admixtures used, date, hour and temperature at time of sampling, percentage air content, unit weight and test strength of cylinder.
- .5 When concrete is placed under the conditions of "Cold Weather Requirements" make one additional cylinder; store it in a heated enclosure for 24 hours and then store it on the job site in a place protected from disturbance and off the ground. Compressive test this cylinder 7 days after sampling.
- .6 Determine the air content of air entrained standard weight concrete.
- .7 Determine the air content and unit weight of light weight concrete by the volumetric method.
- .8 Additional testing required because of changes in materials or proportions of the mix requested by the Contractor as well as any extra testing of concrete or materials occasioned by their failure to meet specification requirements or testing of the structure or performance of the structure, including load testing, shall be carried out at the Contractor's expense.

#### **1.12. INSPECTION OF STRUCTURAL STEEL**

- .1 Ensure all steel has mill test reports that comply with the Specification prior to purchase.
- .2 Inspect fabrication of steel in the plant.
- .3 Inspect erection work at site including fit-up, placing, plumbing, levelling, temporary bracing, field cutting and alterations.
- .4 Shop and field inspect welded and bolted connections and painting.
- .5 High strength bolts - the installation and testing of bolts shall conform to the requirements of CSA S16-1969. Check one representative connection in ten by torque testing every bolt, and check each bolt in every connection with a tap of hammer for soundness. Enforce requirements of connection type.
- .6 Examine visually all welded joints for inclusions, porosity, lack of fusion penetration or even contour, undercuts and cracks. Root passes shall be checked for penetration

---

and cracks from the back of the joint. Any suspect welds shall be checked ultrasonically.

**1.13. INSPECTION OF METAL DECK**

- .1 Check deck for gauge, type and protective coating thickness to ensure compliance with Specification.
- .2 Inspect erection work at the site including anchorage.

**1.14. INSPECTION AND TESTING OF PAVING**

- .1 Testing shall be carried out in three stages as described below by means of sufficient site visits to ensure satisfactory results but in no case less than three site visits.
- .2 Test within 16 hours from time called to do so by the Contractor, since paving is a critical item at the end of the project.
- .3 Stage One:
  - .1 Visual inspection and compaction tests of subsoil.
- .4 Stage Two:
  - .1 Inspection of granular sub-base (after each layer is placed or after the last layer is placed and compacted).
  - .2 On site density tests.
  - .3 Verify thickness of various levels. (Minimum of 4 checks shall be done on thickness in a paved area of 250m<sup>2</sup> or less, and 1 additional check for each additional 250m<sup>2</sup> or part thereof).
  - .4 Laboratory tests: moisture content and grading of materials.
- .5 Stage Three:
  - .1 Inspection of asphalt installation.
  - .2 Checking of thickness and density of material and checking suitability of equipment used.
- .6 Standard Proctor Test shall be carried out for all projects.
- .7 Further, grain size analysis and Marshall test shall be carried out if visual inspection is not satisfactory or, if there is reason to suspect materials supplied are not acceptable.
- .8 All laboratory tests shall be performed according to A.S.T.M. methods, latest revisions
- .9 Paving Contractor shall obtain from their supplier grading tables of materials used and submit them to the testing laboratory for approval. The paving contractor shall ensure material delivered complies with grading tables.

- .10 Be responsible for all approvals given to the Paving Contractor. At completion of the paving project, inform the Consultant all tests were performed according to the Specifications and the Contractor's performance has been approved.
- .11 The Consultant will not entertain any credits for work either not performed or incorrectly performed by the contractor. If thicknesses or consistencies of sub-base are not as specified, or if asphaltic material is not as specified, then the Contractor shall remove the same at their expense and provide proper specified materials.

#### **1.15. BUILDING THERMOGRAPHIC SCAN**

- .1 Upon completion of the Work, the Consultant and/or Owner may arrange for an independent agency to carry out a thermographic scan of the building to determine acceptability of thermal performance of the building envelope.
- .2 Consultant, prior to start of construction work, will designate a sample area of the building to include a portion of exterior wall and roof.
- .3 Consultant will implement a special inspection program for this sample area to be carried out as construction progresses. Contractor shall not cover any completed work until notifying the Consultant and receiving acceptance of completed work. Contractor shall remove and replace any work which is installed in contravention of this requirement.
- .4 Results of a thermographic scan of the entire building will be evaluated and compared to those of the sample area to determine acceptance or rejection of any part of the building envelope.
- .5 Contractor shall carry out remedial work as required to bring the quality of any rejected portion of the building envelope to that of the sample area. Contractor shall pay for costs of any follow-up thermographic scans required to determine acceptability of remedial work. This procedure shall be repeated until all parts of the building envelope have been accepted.

#### **1.16. TESTS AND MIX DESIGNS**

- .1 Furnish test results and mix designs as may be requested.
- .2 The cost of tests and mix designs beyond those called for in Contract Documents or beyond those required by law of Place of Work shall be appraised by Consultant and may be authorized as recoverable.

#### **1.17. MOCK-UP**

- .1 Prepare mock-up for Work specifically requested in specifications. Include for Work of all Sections required to provide mock-ups.

- .2 Prepare mock-ups for Consultants review with reasonable promptness and in an orderly sequence, so as not to cause any delay in Work.
- .3 Failure to prepare mock-ups in ample time is not considered sufficient reason for an extension of Contract Time and no claim for extension by reason of such default will be allowed.
- .4 If requested, Consultant will assist in preparing a schedule fixing dates for preparation.
- .5 Remove mock-up at conclusion of Work or when acceptable to the Consultant. Repair any damage and clean-up at place of mock-up.
- .6 Approved mock-up may remain as part of Work.

**1.18. EQUIPMENT AND SYSTEMS**

- .1 Submit adjustment and balancing reports for mechanical and electrical systems to the consultant.
- .2 Refer to Sections 01.78.10 and 01.79.00 for definitive requirements.

**END OF SECTION**

## **01 51 00 – Temporary Utilities**

### **1.0 GENERAL**

#### **1.1. RELATED SECTIONS**

- .1 Section 01 52 00 - Construction Facilities.
- .2 Section 01 53 00 - Temporary Construction.
- .3 This Section describes requirements applicable to all Sections within Divisions 02 to 49.

#### **1.2. INSTALLATION AND REMOVAL**

- .1 Provide temporary utilities controls in order to execute work expeditiously.
- .2 Location of temporary facilities shall be subject to the Consultant's approval.
- .3 Salvage and assist in recycling products for potential reuse wherever possible.
- .4 Remove temporary facilities from the site when directed by the Consultant.

#### **1.3. DEWATERING**

- .1 Provide temporary drainage and pumping facilities to keep excavations and the site free from standing water. Provide necessary pumps (including spare pumps) and temporary drainage for keeping the Work free of water throughout the construction period. Locate sumps away from foundation elements. Control grading around excavation to prevent surface water from draining into excavation and from damaging adjoining property.

#### **1.4. WATER SUPPLY**

- .1 Provide continuous supply of potable water for construction use until such time as permanent municipal water supply is available.
- .2 Hose extensions to be provided by subcontractors requiring them.
- .3 For New Builds, arrange for connection with the appropriate utility company and pay all costs for installation, maintenance, removal, and usage costs until occupancy has been achieved.
- .4 For Additions and renovations the contractor can use existing Board service unless noted otherwise.

#### **1.5. TEMPORARY HEATING AND VENTILATION**

- .1 Provide temporary heating required during construction period, including unit rental costs, maintenance.

- 
- .2 Provide temporary heating fuel, if not already available on site, until such time as a permanent natural gas line is installed, and thereafter fuel costs shall be borne by the Board. The Contractor shall provide all connections and piping between the permanent fuel source and the heating appliance(s).
  - .3 Provide temporary heat and ventilation in enclosed areas as required to:
    - .1 Facilitate progress of Work.
    - .2 Protect Work and products against dampness and cold.
    - .3 Prevent moisture condensation on surfaces.
    - .4 Provide ambient temperatures and humidity levels for storage, installation and curing of materials.
    - .5 Provide adequate ventilation to meet health regulations for a safe working environment.
  - .4 Maintain temperatures of minimum:
    - .1 10 degrees C in areas where construction is in progress, until takeover by the Board. Contractor to ensure temporary enclosures remain sealed and penetrations are repaired or closed in a timely fashion.
    - .2 16 degrees C in areas where finishes are in progress.
    - .3 16 degrees C in building once it is enclosed.
    - .4 Refer to other Sections for intermittent heating requirements up to 21 degrees C. Provide insulated tarp enclosures for openings as required to enclose the building after completion of main building shell components and roof.
    - .5 If the Contractor fails to ensure the temporary enclosures remained sealed (including temp doors when not in use) the Consultant and or the Board shall require the contractor to pay 40% of that months usage charge
  - .5 Use forced hot air heaters. Open-flame type heaters or salamanders are not permitted. Ventilate direct fired heating units to the outside.
  - .6 Uniformly distribute heat to avoid hot and cold areas and to prevent excessive drying.
  - .7 Early heating of the building shell will be required to expedite interior finishing to meet the project schedule.
  - .8 Ventilating:
    - .1 Prevent accumulations of dust, fumes, mists, vapours or gases in areas occupied during construction.
    - .2 Provide local exhaust ventilation to prevent harmful accumulation of hazardous substances into the atmosphere of occupied areas.
    - .3 Dispose of exhaust materials in a manner that will not result in harmful exposure to persons.

- .4 Ventilate storage spaces containing hazardous or volatile materials.
- .5 Ventilate temporary sanitary facilities.
- .6 Continue operation of ventilation and exhaust system for time after cessation of work process to assure removal of harmful contaminants.
- .7 Provide minimum 1 air change per hour for enclosed areas receiving architectural finishes.
- .8 Do not allow excessive build-up of moisture inside the building.
- .9 The permanent mechanical systems for the new building, when installed in safe operating conditions, may be used for temporary heating or cooling if approved in writing by the Consultant, without penalty to the warranty.
- .10 Follow the requirements of "Temporary Use of New Permanent Services and Equipment" if the permanent heating system installed under the contract is intended to be used for temporary heating during the construction.
- .11 Provide competent persons to operate and maintain permanent systems for the duration of temporary use period.
- .12 Perform required repairs and maintenance immediately after each inspection. Pay for operating costs. Upon termination of temporary use period, services and equipment shall be inspected, tested, adjusted, fitters replaced, balanced, cleaned and lubricated.
- .13 Permanent services and equipment shall be turned over to the Owner in new and perfect operating condition.
- .14 Use of permanent systems and equipment as temporary facilities shall not affect the guarantee conditions and guarantee period for such systems and equipment. Make due allowance to ensure Owner will receive full benefits of the equipment manufacturer's warranty from the date of Substantial Performance.
- .15 Ensure date of Substantial Performance of the Work and Warranties for heating system do not commence until entire system is in as near original condition as possible and is certified by Consultant.
- .16 Maintain strict supervision of operation of temporary heating and ventilating equipment to:
  - .1 Conform with applicable codes and standards.
  - .2 Enforce safe practices.
  - .3 Prevent abuse of services.
  - .4 Prevent damage to finishes.
  - .5 Vent direct-fired combustion units to outside.
- .17 Be responsible for damage to Work due to failure in providing adequate heat and protection during construction.



**1.6. TEMPORARY POWER AND LIGHT**

- .1 Provide temporary electrical service and system including lighting and power system for use by all Sections.
- .2 Contractor will provide a source for, and pay the costs of temporary power during construction for temporary lighting and operating of power tools until such time as a permanent source is available.
- .3 Contractor to ensure that the use of power from a source provided by the Board shall not exceed the capacity of the current use required for the operation of any existing facility.
- .4 Install and maintain temporary electrical service and systems in accordance with Construction Safety Association's "Temporary Wiring Standards on Construction Sites", the Ontario Electrical Code and other authorities having jurisdiction.
- .5 Provide at least one temporary panel on each floor with service capacity suitable for construction requirements and to authorities and utilities approval.
- .6 Provide temporary wiring with lighting to all areas of each floor to provide adequate lighting.
  - .1 Lighting levels must be maintained at a minimum of 10 foot candles, or to suit the particular location or operation, whichever is greater.
  - .2 Do not use materials of the temporary service in permanent installation.
  - .3 Increase lighting levels equivalent to the final requirements when finishing operations are underway.
- .7 Extension cords, lights, etc., required by various subcontractors and run from above outlet positions will be supplied and maintained by the party or parties requiring the same.
- .8 Follow requirements of "Temporary Use of New Permanent Services and Equipment" if electrical power and lighting systems installed under the contract are intended to be used for temporary electricity and lighting during the construction.
- .9 Electrical power and lighting systems installed under this contract can be used for construction provided damages are made good and all lamps that have been used for more than two months are replaced with new lamps.
- .10 For New Builds, arrange for connection with the appropriate utility company and pay all costs for installation, maintenance, removal and usage costs until occupancy has been achieved.
- .11 For Additions and renovations the contractor can use existing Board service unless noted otherwise.
- .12 Provide and pay for temporary power for electric cranes and other equipment requiring temporary power in excess of above noted requirements.

**1.7. TEMPORARY COMMUNICATION FACILITIES**

- .1 Contractor to provide and pay for temporary Phone, e-mail and printer hook up, for the duration of contract until completion for use by the contractor.
- .2 The site superintendent is to have email access and a printer on site.

**END OF SECTION**

## **01 53 00 – Temporary Construction Facilities**

### **1.0 GENERAL**

#### **1.1. RELATED SECTIONS**

- .1 Section 01 51 00 - Temporary Utilities.
- .2 Section 01 35 23 – Health and Safety
- .3 This Section describes requirements applicable to all Sections within Divisions 02 to 49.

#### **1.2. INSTALLATION AND REMOVAL**

- .1 Provide temporary construction facilities in order to execute work expeditiously.
- .2 Remove temporary facilities from the site when directed by the Consultant.

#### **1.3. PROTECTION FOR OFF-SITE AND PUBLIC PROPERTY**

- .1 Protect surrounding private and public property from damage during performance of Work.
- .2 Be responsible for damage incurred.

#### **1.4. PROTECTION OF SURROUNDING WORK**

- .1 Provide protection for finished and partially finished Work from damage.
- .2 Provide necessary cover and protection.
- .3 Be responsible for damage incurred due to lack of or improper or inappropriate protection.

#### **1.5. ROOF AND STRUCTURE PROTECTION**

- .1 Ensure no part of Work or existing structures are subjected to a load, which will endanger its safety or will cause permanent deformation.
- .2 The Contractor when indicated by the Board Contact or Consultant shall provide roof protection. Ensure all precautions are taken to avoid liability for roof damage.
- .3 Typical roof protection shall consist of a layer of 1 inch rigid foam insulation set directly on the roof surface and a layer of 19 mm (3/4 inch) plywood in all places under scaffold legs, ladder legs and in areas of foot traffic or falling debris.

#### **1.6. WORK SITE ENCLOSURE & SAFETY BARRIERS**

- .1 Erect and maintain for the duration of the work:

- .1 a minimum 1800 mm high chain link fence or self-supporting, heavy duty, interconnected fence panels (commonly referred to as Insta-fence) for a temporary site enclosure (hoarding) completely around perimeter of work site,
  - .2 any temporary posts shall be completely removed by the contractor prior to occupancy,
  - .3 under no circumstance shall t-bar posts be used on board property
  - .4 any additional safety devices including full hoarding as required and noted on the drawings, to protect the students, staff, public and private property from injury and damage,
  - .5 any additional requirements as regulated by authorities having jurisdiction, local by-laws and zoning.
- .2 The Contractor is to assume full responsibility for any injury or damage caused due to failure to comply with Paragraph 1 above.
  - .3 Any hazardous conditions identified outside of the main fenced area will be barricaded with a fence complying to the above.
  - .4 Provide lockable truck entrance gate/gates and at least one (1) pedestrian door as directed and conforming to applicable traffic restrictions on adjacent streets. Equip gates with locks and keys with restricted availability, in the project office.
  - .5 Erect and maintain pedestrian walkways including roof and side covers, complete with signs and electrical lighting as required by law.
  - .6 Provide barriers around trees and plants designated to remain.
  - .7 Protect from damage by equipment and construction procedures.

#### **1.7. TREE PROTECTION**

- .1 Protect all existing trees to remain from damage during construction period. Make good, at Contractor's expense, trees damaged during construction.
- .2 Confine movement of heavy equipment, storage of same, and storage of materials to a predetermined area. Do not store materials or place equipment over root systems of any existing trees to remain.
- .3 Install fencing or approved equal at limits of drip line of existing trees to remain unless directed otherwise. Where this case is not practical, and only if approved by the Consultant, the trunks shall be protected with an approved tree guard.
- .4 No rigging cables shall be wrapped around or installed in trees. Do not flush concrete trucks or cement mixing machines over root systems or near trees. Flush concrete trucks or cement mixing machines in areas approved by the Consultant.
- .5 Areas where root systems of trees are exposed directly adjacent to a structure will be backfilled with good loam only.

- .6 Whenever excavating is required within branch spread of trees that are to remain, the contractor shall contact the consultant for direction prior to the start of work.
- .7 If any existing tree to remain is injured and does not survive the following year, it will, as determined by the Board, be removed in its entirety and be replaced with a tree of similar size and value, as directed by the Consultant.
- .8 Should the destroyed tree be of such a size or shape that it cannot be feasibly replaced, the Contractor shall compensate the Owner for the minimum sum of five thousand dollars (\$5,000.00) per destroyed tree.

#### **1.8. GUARD RAILS AND BARRIERS**

- .1 Provide secure, rigid guard rails and barricades around deep excavations, open shafts, open stairwells, open edges of floors and roofs.
- .2 Erect and maintain for the duration of the Work, safety devices and barricades including hoarding, as required, to protect the staff, students, public and private property, from injury and damage.
- .3 The Contractor is to ensure that all requirements from authorities having jurisdiction and all requirements from the Owner are met.
- .4 The Contractor is to assume full responsibility for any damage caused due to his failure to comply with paragraph 2 above.
- .5 Hazardous conditions on the exterior shall be fenced.

#### **1.9. WEATHER ENCLOSURES**

- .1 Provide weather-tight closures to unfinished door and window openings, tops of shafts and other openings in floors and roofs.
- .2 Close off floor areas where walls are not finished; seal off other openings; enclose building interior work for temporary heat.
- .3 Design enclosures to withstand wind pressure.

#### **1.10. DUST TIGHT BARRIERS**

- .1 Provide dust tight barriers and screens or partitions to localize dust generating activities, and for protection of workers, finished areas of Work and public.
- .2 Maintain and relocate protection until such work is complete.
- .3 Where required, adjust air handling units to eliminate migration of dust.

### **1.11. SCAFFOLDING**

- .1 Erect scaffolding independent of walls and use in such a manner limiting interference with other work. When not in use, move scaffolding as necessary to permit installation of other work. Construct and maintain scaffolding in a rigid, secure and safe manner. Remove it promptly when no longer required. Protect the surface on which scaffolding is bearing.

### **1.12. SHORING, BRACING, PILING**

- .1 Provide shoring, bracing, piling, sheeting and sheet piling and underpinning required to support soil banks, existing work and property in accordance with Construction Safety Act and other applicable regulations. Maintain shoring until the building is strong enough and sufficiently braced to withstand pressure of backfilling. Make construction aids free of permanent work so they may be removed entirely when no longer required, without damaging the Work. Locate construction aids so adequate room is left for damp-proofing foundation walls, laying substructure drainage and other work.
- .2 Shoring and false work over one tier in height shall be designed and shall bear the stamp of a registered professional engineer, having experience in this field.

### **1.13. HOISTING**

- .1 Provide, operate and maintain services required for moving of workers, materials and equipment. Make financial arrangements with Subcontractors for use thereof.
- .2 Machinery shall be operated by qualified operator.

### **1.14. OVERHEAD LIFTING**

- .1 Any condition requiring the use of a crane or lifting device over a Board structure must follow the requirements of Health and Safety Section 01 35 23, Paragraph 1.15 Overhead Lifting.

### **1.15. ELEVATORS/LIFTS**

- .1 When elevators/lifts are to be used by construction personnel, provide protective coverings for finish surfaces of elevator cabs and entrances.
- .2 Co-ordinate use of elevator cabs with Consultant and the Board.

### **1.16. USE OF THE WORK**

- .1 Confine work and operations of employees by Contract Documents. Do not unreasonably encumber premises with Products.

- .2 Do not load or permit to load any part of Work with a weight or force that will endanger the Work.

**1.17. CONSTRUCTION PARKING**

- .1 Construction personnel vehicle parking, to be confined to the work site enclosure, or.
- .2 Parking will be permitted on site only where and if it does not disrupt the employees of the place of work as directed by the Board
- .3 Permission to park vehicles on site does not imply any liability or responsibility for safe keeping of vehicles and contents thereof by the School Board.

**1.18. ACCESS TO SITE**

- .1 Provide and maintain adequate access to the project site.
- .2 Build and maintain temporary roads where necessary and provide snow removal within the area of work, and access to the work, during the period of Work. The area shall be restored to the satisfaction of the Board at the completion of the project.
- .3 If authorized to use existing roads for access to project site, maintain such roads for duration of Contract and make good damage resulting from Contractors' use of roads.
- .4 Clean roadways and taxi areas where used by Contractor's equipment.

**1.19. SECURITY**

- .1 The Contractor shall ensure the security of the work site, contents, and built structures for the duration of the project.
- .2 The Contractor shall be responsible to provide and pay for security personnel to guard the site and contents of the site after working hours and during holidays as required.
- .3 Notify the Board of the use of security guards or systems.
- .4 The Board shall not be responsible for the loss, theft, or vandalism.

**1.20. OFFICES**

- .1 Provide and maintain, until completion of Contract, for Contractor's use, a temporary office, large enough to accommodate site administrative activities and site meetings, complete with light, heat, air conditioning, ventilation, table and chairs. Do not store materials in the office area; keep clean and tidy.
- .2 Provide a clearly marked and fully stocked first-aid case in a readily available location.

- .3 Subcontractors may provide their own offices as necessary. Direct location of these offices.

#### **1.21. EQUIPMENT, TOOL AND MATERIALS STORAGE**

- .1 Provide and maintain, in a clean and orderly condition, lockable weatherproof sheds and platforms for storage of tools, equipment and materials.
- .2 Review storage areas on site with the Consultant. Store materials and equipment to ensure preservation of quality of product and fitness for the Work. Store materials and equipment on wooden platforms or other hard, clean surfaces, raised above the ground or in water tight storage sheds of sufficient size for storage of materials and equipment which might be damaged by storage in the open. Locate stored materials and equipment to facilitate prompt inspection.
- .3 Store packaged materials and equipment undamaged, in their original wrappings or containers, with manufacturer's labels and seals intact.
- .4 Locate materials not required to be stored in weatherproof sheds on site in a manner to cause least interference with work activities.
- .5 Storage sheds required by subcontractors shall be provided by them.

#### **1.22. SANITARY FACILITIES**

- .1 Provide weatherproof temporary toilet/sanitary facilities for the work force in accordance with governing regulations and ordinances.
- .2 Service temporary toilet/sanitary facilities as required by authorities but not less than weekly.
- .3 Post notices and take such precautions as required by local health authorities.
- .4 The use of existing washroom facilities is not allowed unless specifically approved by the Board. The Contractor will be required to clean and maintain the existing washrooms to Board standards.
- .5 Except where connected to the municipal sewer system, periodically remove wastes from Site.
- .6 Keep toilet/sanitary facilities clean and sanitary and protect from freezing.
- .7 Keep sanitary facilities clean and fully stocked with the necessary supplies at all times.

**END OF SECTION**



## **01 54 00 – Materials and Equipment**

### **1.0 GENERAL**

#### **1.1. RELATED SECTIONS**

- .1 This Section describes requirements applicable to all Sections within Divisions 02 to 49

#### **1.2. PRODUCT AND MATERIAL QUALITY**

- .1 Products, materials, equipment and articles referred to as “Products”; throughout the specifications incorporated in the Work, shall be new, not damaged or defective, and of the best quality, compatible with specifications for the purpose intended. If requested, furnish evidence as to type, source and quality of products provided.
- .2 Defective products will be rejected, regardless of previous inspections. Inspection does not relieve responsibility, but is a precaution against oversight or error. Remove and replace defective products at own expense, and be responsible for delays and expenses caused by rejections.
- .3 Should any dispute arise as to the quality or fitness of products, the decision rests strictly with the Board contact, based upon requirements of the Contract Documents.
- .4 Current Material Safety Data Sheets shall be on file with the successful Contractor and shall be provided to the Board contact upon request, within twenty-four (24) hours.
- .5 Material safety data sheets are not required for products currently WHMIS exempt.

#### **1.3. EQUIPMENT/TOOL MATERIALS STORAGE, HANDLING, AND PROTECTION**

- .1 Handle and store products in a manner to prevent damage, adulterations, deterioration, and soiling, and in accordance with manufacturer’s instructions.
- .2 Store packaged or bundled products in original and undamaged condition, with manufacturer’s seals and labels intact.
- .3 Store products subject to damage from weather in weatherproof enclosures.
- .4 Provide and maintain tools, equipment and materials in a clean and orderly condition. Board tools, ladders, lifts, power cords, flashlights etc. are not to be used.
- .5 Materials are to be stored in a manner to cause the least interference with Work activities.

- .6 The Contractor shall determine with the Board contact, prior to ordering materials, those locations that are suitable for receiving and storage of materials and equipment.
- .7 All materials and equipment shall be kept in a secure area, at Contractor's expense, or removed from the job site when Work is not actually in progress.
- .8 Vehicles, trailers or other similar apparatus may not be stored or parked overnight at site without written authorization from Board contact. Written requests are to be forwarded directly to the Board contact.
- .9 Approval for parking does not imply any liability or responsibility for safe keeping by the Board.
- .10 The Contractor may use the existing electrical and water services, as required, for the Work, and the costs of these services shall be borne by the Board.

#### **1.4. WORKMANSHIP**

- .1 Workmanship shall be the best quality, executed by Workers experienced and skilled in the respective duties for which they are employed. Immediately notify the Consultant if required Work is such as to make it impractical to produce required results.
- .2 Do not employ any unfit persons or anyone unskilled in their required duties.
- .3 Decisions as to the quality or fitness of Workmanship in cases of dispute rest solely with the Board contact, whose decision is final.
- .4 All Contractor personnel are restricted to the job site and necessary access routes. No personnel shall visit other areas or buildings without specific authorization.
- .5 The Contractor shall make their own arrangements for emergency treatment of accidents.
- .6 Any accidents shall be reported immediately to the Board contact.
- .7 The Contractor agrees to hold the Board harmless of any and all liability of every nature and description, which may be suffered through bodily injuries, involving deaths of any persons, by reasons of negligence of the Contractor, his agents, employees, or his Subcontractors.
- .8 The Contractor shall supply constant on-site supervision in the form of a Project Superintendent. The Project Superintendent shall have within their authority to negotiate minor changes regarding scheduling, manpower and equipment.

**1.5. MANUFACTURER'S INSTRUCTIONS**

- .1 Unless otherwise indicated in the specifications, install, apply or erect products in accordance with manufacturer's instructions. Do not rely on labels or enclosures provided with products. Obtain written instructions directly from manufacturers.

**1.6. TOOLS OF THE TRADE**

- .1 The Board will not pay the Awarded Bidder a fee for tools and equipment that are considered "tools of the trade" that are required to perform the work in this Tender or any change orders.

**1.7. EXISTING EQUIPMENT**

- .1 Contractor shall demolish and dispose of all existing equipment specified to be removed and or replaced including obsolete services not being reused. The Board shall have first rights of refusal on all demolished equipment and or parts and the Contractor shall provide a minimum of (5) working days notice prior to disposal of the equipment, parts, or equipment and set aside same in a suitable location to be recovered by Board technicians.

**END OF SECTION**

## **01 61 00 – Product Requirements**

### **1.0 GENERAL**

#### **1.1. RELATED SECTIONS**

- .1 This Section describes requirements applicable to all Sections within Divisions 02 to 49.
- .2 Section 01 31 00 – Project Managing and Coordination

#### **1.2. TERMINOLOGY**

- .1 New: Produced from new materials.
- .2 Renewed: Produced or rejuvenated from an existing material to like-new condition to serve a new or existing service.
- .3 Defective: A condition determined exclusively by the Consultant.

#### **1.3. PRODUCT QUALITY**

- .1 The term 'new' in the following paragraph does not exclude re-manufactured products that have some or all of the materials recycled from other sources. Preference in recycling is for post-consumer recycled materials.
- .2 Products, materials, equipment, parts or assemblies (referred to as Products) incorporated in Work:
- .3 New Product, not damaged or defective, of best quality (compatible with specification requirements) for purpose intended. If requested, provide evidence as to type, source and quality of Products provided.
- .4 Defective Products, whenever identified prior to completion of Work, will be rejected, regardless of previous inspections. Inspection does not relieve responsibility, but is precaution against oversight or error. Remove and replace defective Products at own expense and be responsible for delays and expenses caused by rejection.
- .5 Should any dispute arise as to the quality or fitness of Products, decision rests strictly with Consultant.
- .6 Unless otherwise indicated in specifications, maintain uniformity of manufacture for any particular or like item throughout the building.

**1.4. AVAILABILITY**

- .1 Immediately upon receipt of the Board's Purchase Order, review Product delivery requirements and anticipate foreseeable supply delays for any items.
- .2 Immediately upon receipt of the Board's Purchase Order the Contractor shall issue Purchase Orders and or Contracts to all Sub-trades. Provide proof to the Consultant and the Board within 3 days. The Subcontractors shall identify in writing any delivery issues within 14 days of receiving the Contractor's purchase order or contract. The Schedule noted in 01-31 00 1.7.1 shall incorporate all deliveries and installation.
- .3 If delays in supply of Products are foreseeable, notify Consultant of such, in order that substitutions or other remedial action may be authorized in ample time to prevent delay in performance of Work.
- .4 In the event of failure to notify Consultant at commencement of Work and should it subsequently appear that Work may be delayed for such reason, Consultant reserves the right to substitute more readily available Products of similar character, at no increase in Contract Price or Contract Time.

**1.5. STORAGE AND PROTECTION**

- .1 Store and protect Products in accordance with manufacturers' written instructions.
- .2 Store with seals and labels intact and legible.
- .3 Store sensitive Products in weather tight, climate controlled, enclosures in an environment favourable to Product.
- .4 For exterior storage of fabricated Products, place on sloped supports above ground.
- .5 Cover Products subject to deterioration with impervious sheet covering. Provide ventilation to prevent condensation and degradation of Products.
- .6 Store loose granular materials on solid flat surfaces in a well-drained area. Prevent mixing with foreign matter.
- .7 Provide equipment and personnel to store Products by methods to prevent soiling, disfigurement, or damage.
- .8 Arrange storage of Products to permit access for inspection. Periodically inspect to verify Products are undamaged and are maintained in acceptable condition.

**1.6. TRANSPORTATION AND HANDLING**

- .1 Transport and handle Products in accordance with manufacturer's written instructions.
- .2 Promptly inspect shipments to ensure that Products comply with requirements, quantities are correct, and Products are undamaged.

- .3 Provide equipment and personnel to handle Products by methods to prevent soiling, disfigurement, or damage.
- .4 Suitably pack, crate and protect products during transportation to site to preserve their quality and fitness for the purpose intended.
- .5 Store products in original, undamaged condition with manufacturer's labels and seals intact until they are being incorporated into completed work.
- .6 Protect materials from damage by extreme temperatures or exposure to the weather.

**1.7. EXISTING UTILITIES**

- .1 When breaking into or connecting to existing services or utilities, execute Work at times directed by local governing authorities, with minimum disturbance to the owner.
- .2 Protect, relocate or maintain existing active services. When services are encountered, cap off in a manner approved by authority having jurisdiction. Stake and record location of capped service.

**1.8. MANUFACTURER'S WRITTEN INSTRUCTIONS**

- .1 Unless otherwise indicated in specifications, install or erect Products to manufacturer's written instructions. Do not rely on labels or enclosures provided with Products. Obtain written instructions directly from manufacturers.
- .2 Notify Consultant in writing, of conflicts between specifications and manufacturer's instructions, so that Consultant may establish course of action.
- .3 Improper installation or erection of Products, due to failure in complying with these requirements, authorizes Consultant to require removal and reinstallation at no increase in Contract Price or Contract Time.

**1.9. QUALITY OF WORK**

- .1 Ensure Quality of Work is of highest standard, executed by workers experienced and skilled in respective duties for which they are employed. Immediately notify Consultant if required Work is such as to make it impractical to produce required results.
- .2 Do not employ anyone unskilled in their required duties. Consultant and or Board reserves right to require dismissal from site any workers deemed incompetent or careless.
- .3 Decisions as to standard or fitness of Quality of Work in cases of dispute rest solely with Consultant, whose decision is final.

- .4 Products, materials, systems and equipment shall be applied, installed, connected, erected, used, cleaned and conditioned in accordance with the applicable manufacturer's printed directions.
- .5 Where specified requirements are in conflict with manufacturer's written directions, follow manufacturer's directions. Where specified requirements are more stringent than manufacturer's directions, comply with specified requirements.

#### **1.10. COORDINATION**

- .1 Ensure cooperation of workers in laying out Work. Maintain efficient and continuous supervision.
- .2 Be responsible for coordination and placement of openings, sleeves and accessories.
- .3 Contractor is responsible to ensure suppliers or distributors of materials specified or alternatives accepted, which he intends to use, have materials with original schedule, and similarly it shall be the responsibility of all subcontractors and suppliers to so inform the Contractor.
- .4 Contractor shall contact Consultant immediately upon receipt of information indicating materials or items, will not be available on time, in accordance with the latest approved schedule, and similarly it shall be the responsibility of all subcontractors and suppliers to so inform the Contractor.
- .5 The above, in no way releases the Contractor, or their subcontractors and suppliers of their responsibility for ensuring timely ordering of materials and items required, including the necessary expediting, to complete the Work as scheduled in accordance with the Contract Documents including temp accommodations and or materials to ensure occupancy date is achieved.

#### **1.11. CONCEALMENT**

- .1 In finished areas, conceal pipes, ducts and wiring in floors, walls and ceilings, except where indicated otherwise.
- .2 Before installation, inform the Consultant if there is interference. Install as directed by the Consultant at no additional cost to the Board.

#### **1.12. REMEDIAL WORK**

- .1 Perform remedial work required to repair or replace parts or portions of Work identified as defective or unacceptable. Coordinate adjacent affected Work as required.
- .2 Perform remedial work by specialists familiar with materials affected. Perform in a manner to neither damage nor put at risk any portion of Work.

**1.13. LOCATION OF FIXTURES**

- .1 Inform Consultant of conflicting installation. Install as directed.

**1.14. FASTENINGS - EQUIPMENT**

- .1 Use fastenings of standard commercial sizes and patterns with material and finish suitable for service.
- .2 Use heavy hexagon heads, semi-finished unless otherwise specified. Use Type 304 or 316 stainless steel for exterior areas.
- .3 Bolts may not project more than one diameter beyond nuts.
- .4 Use plain type washers on equipment, sheet metal and soft gasket lock type washers where vibrations occur. Use resilient washers with stainless steel.

**1.15. PROTECTION OF WORK IN PROGRESS**

- .1 Prevent overloading of any part of the Project.
- .2 Do not cut, drill or sleeve any load bearing structural member, unless specifically indicated, without written approval of the Consultant.

**END OF SECTION**



## **01 70 00 – Examination and Preparation**

### **1.0 GENERAL**

#### **1.1. RELATED SECTIONS**

- .1 This section describes requirements applicable to all Sections within Divisions 02 to 49.

#### **1.2. REFERENCES**

- .1 Owner's identification of existing survey control points and property limits.

#### **1.3. SUBMITTALS**

- .1 Submit name and address of Surveyor to Consultant.
- .2 On request of Consultant, submit documentation to verify accuracy of field engineering work.
- .3 Submit certificate signed by surveyor certifying that elevations and locations of completed Work conforms with Contract Documents.

#### **1.4. QUALIFICATIONS OF SURVEYOR**

- .1 Qualified registered land surveyor, licensed to practice in the Place of the Work.

#### **1.5. SURVEY REFERENCE POINTS**

- .1 Existing base horizontal and vertical control points are designated on Drawings.
- .2 Locate, confirm and protect control points prior to starting site Work. Preserve permanent reference points during construction.
- .3 Make no changes or relocations without prior written notice to the Consultant.
- .4 Report to Consultant when reference point is lost or destroyed, or requires relocation because of necessary changes in grades or locations.
- .5 Require the surveyor to replace control points in accordance with original survey control.

#### **1.6. SURVEY REQUIREMENTS**

- .1 Establish existing and new permanent bench marks on site, referenced to established benchmarks by survey control points.
- .2 Record locations, with horizontal and vertical data in Project Record Documents.
- .3 Establish lines and levels, locate and lay out, by instrumentation.
- .4 Establish pipe invert elevations.

- .5 Stake batter boards
- .6 Establish foundation and floor elevations.
- .7 Establish lines and levels for mechanical and electrical work.

### **1.7. SUBSURFACE CONDITIONS**

- .1 Promptly notify Consultant in writing if discovered surface or subsurface conditions at Place of Work differ materially from those indicated in Contract Documents.
- .2 Advise the Consultant of a reasonable assumption of probable conditions when determined.
- .3 After prompt investigation, should Consultant determine that conditions do differ materially, instructions will be issued for changes in Work.

### **1.8. EXAMINATION**

- .1 The Contractor is expected to be totally familiar with site conditions and shall assume full responsibility for the cost involved in repairing any damage to the building, site and services, city property, adjacent buildings, etc., during general construction, regardless of the extent of the damage.
- .2 Inspect existing conditions, including elements or adjacent Work subject to irregularities, damage, movement, including Work during cutting and patching.
- .3 The Contractor shall provide all equipment necessary to make a full and detailed site evaluation. This shall include but not be limited to ladders, flashlights and hand tools.
- .4 The Contractor expressly agrees that conditions above existing suspended acoustic ceilings, but below fixed structure, unless obscured by an additional ceiling above, shall be considered exposed conditions for the purposes of making findings under the provisions of the Contract. There shall be no claims for extra costs for extra Work in these areas.
- .5 After uncovering, inspect conditions affecting performance of the Work.
- .6 Beginning of cutting or patching means acceptance of existing conditions.

### **1.9. PREPARATION**

- .1 Provide supports to assure structural integrity of surroundings; provide devices and methods to protect other portions of the project from damage.
- .2 Provide protection from elements for areas which may be exposed by uncovering work; maintain excavations free of water.

**1.10. EXISTING SERVICES**

- .1 Before commencing work, establish location and extent of service lines in the area of Work and notify the Consultant of findings.
- .2 Remove abandoned service lines running through existing and new structures. Cap or seal lines at cut-off points as directed by the Consultant.

**1.11. LOCATION OF EQUIPMENT AND FIXTURES**

- .1 Inform Consultant of conflicting installations, install as directed.
- .2 Locate equipment, fixtures and distribution systems to provide minimum interference and maximum usable space and in accordance with manufacturer's recommendations for safety, access and maintenance.
- .3 Inform Consultant of impending installation and obtain approval for actual location.
- .4 Submit field drawings to indicate relative position of various services and equipment when required by Consultant.

**1.12. SURVEY RECORD**

- .1 Maintain a complete, accurate log of control and survey work as it progresses.
- .2 On completion of foundations and major site improvements, prepare a certified survey showing dimensions, locations, angles and elevations of Work.
- .3 Record locations of maintained, re-routed and abandoned service lines.

**END OF SECTION**

## **SECTION 01 73 30 – EXECUTION AND CUTTING AND PATCHING**

### **1.0 GENERAL**

#### **1.1. RELATED SECTIONS**

- .1 Section 01 32 00 - Construction Progress Documentation: Submittals and scheduling.
- .2 Section 01 61 00 - Product Requirements.
- .3 Section 01 70 00 – Examination and Preparation
- .4 Individual Product Specification Sections:
  - .1 Cutting and patching incidental to work of the section.
  - .2 Advance notification to other sections of openings required in Work of those Sections.

#### **1.2. SUBMITTALS**

- .1 Submit written request in advance of cutting or alteration which affects:
  - .1 Structural integrity of any element of Project.
  - .2 Integrity of weather exposed or moisture resistant element.
  - .3 Efficiency, maintenance, or safety of any operational element.
  - .4 Visual qualities of sight exposed elements.
  - .5 Work of Owner or separate contractor.
- .2 Include in request:
  - .1 Identification of Project.
  - .2 Location and description of affected Work.
  - .3 Necessity for cutting or alteration.
  - .4 Description of proposed Work and Products to be used.
  - .5 Alternatives to cutting and patching.
  - .6 Effect on work of Owner or separate contractor.
  - .7 Written permission of affected separate contractor.
  - .8 Date and time work will be executed.

#### **1.3. TOLERANCES**

- .1 Monitor fabrication and installation tolerance control of Products to produce acceptable Work.
- .2 Do not permit tolerances to accumulate beyond effective or practical limits.

- .3 Comply with manufacturers' tolerances. In case of conflict between manufacturers' tolerances and Contract Documents, request clarification from the Consultant before proceeding.
- .4 Adjust Products to appropriate dimensions; position and confirm tolerance acceptability, before permanently securing Products in place.

## **2.0 PRODUCTS**

### **2.1. MATERIALS**

- .1 Primary Products: Those required for original installation.
- .2 Product Substitution: For any proposed change in materials, submit a request for substitution described in Section 01 33 00.

## **3.0 EXECUTION**

### **3.1. EXAMINATION**

- .1 Examine existing conditions prior to commencing Work, including elements subject to damage or movement during cutting and patching.
- .2 After uncovering existing Work, assess conditions affecting performance of work.
- .3 Beginning of cutting or patching means acceptance of existing conditions.

### **3.2. PREPARATION**

- .1 Provide temporary supports to ensure structural integrity of the Work. Provide devices and methods to protect other portions of the Project from damage.
- .2 Provide protection from elements for areas which may be exposed by uncovering work.
- .3 Maintain excavations free of water.

### **3.3. CUTTING**

- .1 Execute cutting and fitting as needed to complete the Work. Prior to any cutting and or coring of concrete floors the contractor shall confirm the area is free of services or rebar. Notify the Consultant of any interferences.
- .2 Uncover work to install improperly sequenced work.
- .3 Remove and replace defective or non-conforming work.
- .4 Remove samples of installed work for testing for Hazardous materials.
- .5 Provide openings in the Work for penetration of mechanical and electrical work.

- .6 Employ experienced installer to perform cutting for weather exposed and moisture resistant elements, and sight exposed surfaces.
- .7 Cut rigid materials using a masonry saw or core drill. Pneumatic tools are not allowed without prior approval.
- .8 Do all cutting, patching, and making good, to leave a finished condition and to make the several parts of the work come together properly. Coordinate work to keep cutting and patching to a minimum.
- .9 Make cuts with clean, true, smooth edges. Fit unit to tolerance established by test standard practice for applicable work. Make patches invisible in the final assembly.
- .10 Cutting shall be done in a manner to keep patching to minimum. Obtain Consultant's approval of method to be used to conceal new mechanical and electrical services before beginning cutting. Chasing of concrete surfaces is not permitted.
- .11 Cutting or coring of any structural concrete is to be reviewed and approved by the Consultant.
- .12 Do not endanger any work by cutting, digging or otherwise altering, and do not cut nor alter any load bearing element without written authorization by Consultant. Provide bracing, shoring and temporary supports as required to keep construction safely supported at all times
- .13 Any cost caused by omission or ill-timed work shall be borne by the party responsible thereof.
- .14 Regardless of which Section of work is responsible for any portion of cutting and patching, in each case tradesmen qualified in work being cut and patched shall be employed to ensure it is correctly done.

### **3.4. PATCHING**

- .1 Execute patching to complement adjacent Work.
- .2 Fit Products together to integrate with other Work.
- .3 Execute work by methods to avoid damage to other Work, and which will provide appropriate surfaces to receive patching and finishing.
- .4 Employ original installer to perform patching for weather exposed and moisture resistant elements, and sight-exposed surfaces.
- .5 Restore work with new Products in accordance with requirements of Contract Documents.
- .6 Fit work with adequate support to pipes, sleeves, ducts, conduit, and other penetrations through surfaces.
- .7 At penetrations of fire rated walls, partitions, ceiling, or floor construction, completely seal voids with firestop material.

- .8 Refinish surfaces to match adjacent finish. For continuous surfaces, refinish to the nearest intersection or natural break. For an assembly, refinish the entire unit.
- .9 Complete and tightly fit all construction to pipes, ducts and conduits which pass through construction to completely prevent the passage of air.
- .10 Patching and making good shall be done by trade specialists in material to be treated, and shall be made undetectable in finished work when viewed from a distance of 1.5m under normal lighting.

**END OF SECTION**

## **01 74 00 – Cleaning and Waste Management**

### **1.0 GENERAL**

#### **1.1. RELATED SECTIONS**

- .1 Common Work by All Trades
- .2 This Section describes requirements applicable to all Sections within Divisions 02 to 49.
- .3 Conduct cleaning and disposal operations to comply with local ordinances and environmental protection legislation.
- .4 Store volatile wastes in covered metal containers, and remove them from premises at the end of each working day.
- .5 Provide adequate ventilation during use of volatile or noxious substances. Use of building ventilation systems is not permitted for this purpose.

### **2.0 PRODUCTS**

#### **2.1. CLEANING PRODUCTS**

- .1 Cleaning Agents and Materials: Low VOC content wherever possible. The Consultant and the Board shall be notified prior to use of any exception.

### **3.0 EXECUTION**

#### **3.1. CLEANING DURING CONSTRUCTION**

- .1 Maintain the Work in tidy condition, free from accumulation of waste products and debris, other than that caused by the Owner or other Contractors.
- .2 Remove waste material and debris from the work areas and deposit in a waste container at the end of each working day.
- .3 Vacuum clean interior areas prior to the start of finishing work. Maintain areas free of dust and other contaminants during finishing operations.
- .4 Individual Subcontractors are responsible for the daily clean-up and removal of debris related to, or generated by, their own work. The overall responsibility for project cleanliness rests with the Contractor.
- .5 The Contractor shall be responsible for snow removal within the construction area.
- .6 Make arrangements with and obtain permits from authorities having jurisdiction for disposal of waste and debris.
- .7 Wherever possible recycle materials



- .8 Containers:
  - .1 Provide adequate number and sizes of on-site garbage and recycling containers within designated work site as required for collection of waste materials and debris on a daily basis.
  - .2 Provide additional waste containers when the extent of work warrants.
  - .3 Provide and use clearly marked, separate bins for recycling.
- .9 Dispose of waste materials and debris at registered waste disposal and recycling facility.
- .10 Remove oily rags, waste and other hazardous substances from premises at close of each day, or more often when required.
- .11 Schedule cleaning operations so that resulting dust, debris and other contaminants will not fall on wet, newly painted surfaces nor contaminate building systems.

### **3.2. WASTE MANAGEMENT**

- .1 Audit, separate and dispose of construction waste generated by new construction or by demolition of existing structures in whole or in part, in accordance with Ontario Regulations 102/94 and 103/94 made under the Environmental Protection Act.
- .2 Containers:
  - .1 Provide adequate number and sizes of on-site garbage and recycling containers within designated work site as required for collection of waste materials and debris on a daily basis.
  - .2 Provide additional waste containers when the extent of work warrants.
  - .3 Provide and use clearly marked, separate bins for recycling.
- .3 Fires, and burning of rubbish or waste on site is strictly prohibited.
- .4 Burying of rubbish or waste materials on site is strictly prohibited.
- .5 Disposal of waste or volatile materials such as mineral spirits, oil, gasoline or paint thinner into ground, waterways, or sewer systems is prohibited.
- .6 Empty waste containers on a regular basis to prevent contamination of site and adjacent properties by wind-blown dust or debris

### **3.3. PREPARATION FOR FINAL CLEANING**

- .1 Prior to final cleaning the General Contractor shall:
  - .1 remove all surplus products, tools, construction machinery and equipment not required for the performance of remaining work, and thereafter remove any remaining materials, equipment, waste and debris,
  - .2 replace all filters installed on any equipment in operation in the area of work,

- .3 remove all paint spots or overspray from all affected surfaces, and

### **3.4. FINAL CLEANING PRIOR TO ACCEPTANCE: INTERIOR**

- .1 Prior to applying for Substantial Performance of the Work, or, prior to Owner occupancy of the building or portion of the building affected by the Work, whichever comes first, conduct full and complete final cleaning operations for the areas to be occupied.
- .2 Final cleaning operations shall be performed by an experienced professional cleaning company, possessing equipment and personnel sufficient to perform full building cleaning operations. Contractors “broom cleaning” is not acceptable as a “Final Clean”. The cleaning contractor shall:
  - .1 clean interiors of all millwork and surfaces of any furniture and equipment present,
  - .2 use only cleaning materials recommended by the manufacturer of the surface to be cleaned,
  - .3 remove all stains, spots, scuff marks, dirt, dust, remaining labels, adhesives or other surface imperfections,
  - .4 clean and polish all glass and mirrors and remove remaining manufacturer's and safety "X" labels,
  - .5 clean and polish all finished metal surfaces such as enameled or stainless steel, chrome, aluminum, brass, and bronze,
  - .6 clean and polish all vitreous surfaces such as plumbing fixtures, ceramic tile, porcelain enamel, or other such materials,
  - .7 clean all ceramic tile surfaces in accordance with the manufacturer's instructions,
  - .8 vacuum, clean and dust behind grilles, louvres and screens,
  - .9 steam clean all unprotected carpets immediately prior occupancy by Owner, and
  - .10 clean all equipment and fixtures to a sanitary condition.
- .3 For any areas to be occupied after the owner's initial occupancy, provide full cleaning operations as outlined above prior to turning over to owner,
- .4 The Board's supplies and equipment must not be used for any cleaning operations including, but not limited to: garbage cans, mops, brooms, rags, ladders, chemicals etc.

**3.5. FINAL CLEANING PRIOR TO ACCEPTANCE: EXTERIOR**

- .1 For areas affected by construction final exterior cleaning operations shall be performed by the General Contractor or competent Subcontractor. Contractor's "broom cleaning" only is not acceptable.
- .2 Final exterior cleaning shall include:
  - .1 broom clean and wash exterior walkways, steps, and surfaces; rake clean other surfaces of grounds,
  - .2 remove dirt and other disfiguration from exterior surfaces,
  - .3 sweep and wash clean paved areas,
  - .4 replace filters of mechanical equipment for all equipment that was in use during construction,
  - .5 clean all roofs, gutters, downspouts, areaways, drywells, and drainage systems,
  - .6 remove debris and surplus materials from crawl areas and other accessible concealed spaces.
  - .7 remove overspray

**END OF SECTION**

## **01 78 10 – Closeout Submittals and Requirements**

### **1.0 GENERAL**

#### **1.1. RELATED SECTIONS**

- .1 Section 01 78 10 – WRDSB Warranty Card, Appendix 00 41 13A

#### **1.2. TAKE-OVER PROCEDURES**

- .1 Take over procedures will be in strict accordance with the requirements as set out in this Section.

#### **1.3. SUBSTANTIAL PERFORMANCE**

- .1 Prior to requesting a Substantial Performance deficiency inspection submit 2 hard copies, 1 digital copy of the Operating and Maintenance Manuals for Consultants approval.
- .2 Application for Substantial Performance must include.
  - .1 One (1) electronic copy of inspection and acceptance certificates required from regulatory agencies, including but not limited to.
    - .1 Certificates of Approval of the Work by the local Building Department.
    - .2 Electrical Inspection Certificate of Inspection.
    - .3 Fire Alarm Verification Certificate.
  - .3 Advise Consultant in writing, when the project has been substantially completed. If Consultant agrees this stage has been reached, the Consultant shall prepare a complete list of deficiencies and submit copies of this list to Contractor and the Board.

#### **1.4. COMMENCEMENT OF LIEN PERIODS**

- .1 The date of publication of the Certificate of Substantial Performance of the Work, provided to the contractor by the Consultant, shall be the date for commencement of the lien period.

#### **1.5. TOTAL PERFORMANCE**

- .1 Prior to requesting a final inspection submit written certificate that the following have been performed:
  - .1 Work has been completed and inspected for compliance with Contract Documents and is ready for final inspection
  - .2 Defects have been corrected and deficiencies have been completed.

- .3 Equipment and systems have been tested and are fully operational. Submit two copies of the balancing reports
- .4 Certificates required by the contractor have been submitted.
- .5 Operation of systems have been demonstrated to Owner's personnel.
- .6 Submit Record drawings.
- .7 Submit maintenance materials.
- .8 Provide certified site survey
- .2 When items noted above are completed, request final inspection of Work by consultant, and building inspector. If Work is deemed incomplete by Consultant, complete outstanding items and request re-inspection.

**1.6. PAYMENT OF SUBSTANTIAL PERFORMANCE HOLDBACK**

- .1 Prior to the release of lien holdback provide one copy of the following by the Contractor and each subcontractor:
  - .1 Statutory Declaration or Declaration of Last supply
  - .2 Workplace Safety and Insurance Board "Certificate of Clearance".
- .2 The Contractor shall submit an application for payment of the holdback amount.
- .3 After the receipt of an application for payment which will include a Statutory Declaration and WSIB Clearance from the, the Consultant will issue a certificate for payment of the holdback amount.

**1.7. FINAL PAYMENT**

- .1 When the Contractor considers final deficiencies and defects have been corrected and it appears requirements of Contract have been completed, make application for final payment.
- .2 When the Consultant finds the Contractor's application for final payment valid, the Consultant will issue a final certificate of payment
- .3 The Board reserves the right to charge the Contractor for school access card(s) that have not been returned.
- .4 The cost to reprogram or replace the card(s) access system is estimated at \$50.00 (fifty dollars) for each card issued, \$30.00 (thirty dollars) for each keybox key, plus \$35.00 (thirty five dollars) administration fee.

**1.8. CLOSEOUT SUBMITTALS**

- .1 Prepare instructions and data using personnel experienced in maintenance and operation of described products and submit them to the Consultant for review.
- .2 Copy will be returned to the contractor with the Consultant's comments.

- .3 Revise content of documents as required prior to final submission.
- .4 Two (2) weeks prior to Substantial Performance of the Work, submit to the Consultant, the final copies of operating and maintenance manuals.
- .5 Ensure spare parts, maintenance materials and special tools provided are new, undamaged or defective, and of same quality and manufacture as products provided in Work.
- .6 If requested, furnish evidence as to type, source and quality of products provided.
- .7 Defective products will be rejected, regardless of previous inspections. Replace products at own expense.
- .8 Pay costs of transportation.

### **1.9. OPERATION AND MAINTENANCE MANUAL FORMAT**

- .1 Provide two copies of operating and maintenance data, prepared on 215 X 280mm sheets in printed or typewritten form, contained in 3-ring binders with soft vinyl covers for materials and equipment which require special maintenance or operating procedures.
- .2 When multiple binders are used, correlate data into related consistent groupings. Identify contents of each binder at the front of each volume.
- .3 Cover: Identify each binder with type or printed title 'Project Record Documents'; list title of project and identify subject matter of contents.
- .4 Arrange content by the divisions of the specifications under Section numbers and sequence of Table of Contents.
- .5 Provide tabbed fly leaf for each separate product and system, with typed description of product and major component parts of equipment.
- .6 Include the following in each manual:
  - .1 Complete list of subcontractors and suppliers, their addresses and telephone numbers. Provide 24 hour emergency telephone numbers for such subcontractors as Plumbing, Electrical, Sprinklers, Fire System, Heating, etc.
  - .2 Specified warranties for contractor, each subcontractor and supplier.
  - .3 WRDSB Project Asset and Warranty Card, Appendix 00 41 13A
  - .4 Copy of finish hardware list, complete with all amendments and revisions and lock manufacturer's descriptive and service literature.
  - .5 Schedule of paints and coatings. Include sufficient explanation to fully identify each surface with the applicable paint or coating used. Enclose a copy of the colour schedule.
  - .6 Maintenance instructions for finished surfaces.
  - .7 Brochures, cuts of equipment and fixtures.

- .8 Operating and maintenance instructions for equipment.
- .9 Submit copies of letters from manufacturers of equipment and systems indicating their technical representatives have inspected and tested systems and are satisfied with methods of installation, connection and operations. These letters shall state names of persons present at testing, methods used and list of functions performed.
- .10 Submit one complete set of reviewed shop drawings of architectural, structural, mechanical and electrical items, folded to 215 x 280mm size, contained in heavy duty manila envelopes, numbered and labelled. Follow specification format with no more than one Section per envelope, hard copy and PDF.
- .11 Relevant certificates issued by authorities having jurisdiction
- .12 Computer disc or flash drive with all the above documentation in PDF format

#### **1.10. RECORDING ACTUAL SITE CONDITIONS**

- .1 Record information on a set of black line opaque drawings, and within the Project Manual.
- .2 Annotate with coloured felt tip marking pens, maintaining separate colours for each major system, for recording changed information.
- .3 Record information concurrently with construction progress. Do not conceal Work of the Project until required information is accurately recorded.
- .4 Contract drawings and shop drawings: legibly mark each item to record actual construction, including:
  - .1 Measured depths of elements of foundation in relation to finish first floor datum.
  - .2 Measured horizontal and vertical locations of underground utilities and appurtenances, referenced to permanent surface improvements.
  - .3 Measured locations of internal utilities and appurtenances, referenced to visible and accessible features of construction.
  - .4 Field changes of dimension and detail.
  - .5 Changes made by change orders.
  - .6 Details not on original Contract Drawings.
  - .7 References to related shop drawings and modifications.
- .5 Specifications: legibly mark each item to record actual construction, including:
  - .1 Manufacturer, trade name, and catalogue number of each product actually installed, particularly optional items and substitute items.
  - .2 Changes made by Addenda and change orders.

- .6 Other Documents: Maintain warranties, test reports and samples required by individual specifications sections.

**1.11. RECORD (AS-BUILT) DOCUMENTS AND SAMPLES**

- .1 Store AS-BUILT documents and samples in the field office apart from documents used for construction. Provide files, racks, and secure storage.
- .2 Label AS-BUILT documents and file in accordance with section number listings in List of Contents of the Project Manual. Label each document AS-BUILT DOCUMENTS in neat, large, printed letters.
- .3 Maintain AS-BUILT documents in clean, dry and legible condition. Do not use as-built documents for construction purposes.
- .4 Keep as-built documents and samples available for inspection by the Consultant.

**1.12. RECORD DRAWINGS**

- .1 Prior to Substantial Performance of the Work, update the marked up information from the AS-BUILT documents to a master set of drawing.
- .2 Submit one set of completed AS-BUILT documents to the Consultant for review.
- .3 Documents will be returned to the contractor with the Consultant's comments.
- .4 Revise content of documents as required prior to final submission.
- .5 After the review is completed resubmit to the Consultant for Consultant to produce electronic record drawings for the owner to use.

**1.13. SPARE PARTS**

- .1 Provide spare parts, in quantities specified in individual specification sections.
- .2 Provide items of same manufacture and quality as items in Work.
- .3 Receive and catalogue all items. Submit inventory listing to Consultant. Include approved listings in the Maintenance Manual.
- .4 Obtain receipt for delivered products and submit prior to final payment.

**1.14. REPLACEMENT (MAINTENANCE) MATERIALS**

- .1 Deliver to site, unload and store where directed, replacement (maintenance) materials as required elsewhere in these Specifications. Obtain a signed receipt from the Owner's Representative for delivered materials and include a copy of receipt in Operation and Maintenance manuals.
- .2 Package materials so they are protected from damage and loss of essential properties.
- .3 Label packaged materials for proper identification of contents.



**1.15. SPECIAL TOOLS**

- .1 Provide special tools, in quantities specified in the individual specification section.
- .2 Provide items with tags identifying their associated function and equipment.
- .3 Receive and catalogue all items. Submit inventory listing to Consultant. Include approved listings in Maintenance Manual

**1.16. FINAL SITE SURVEY**

- .1 NOT APPLICABLE.

**1.17. WARRANTIES AND BONDS**

- .1 Separate each warranty or bond with index tab sheets keyed to Table of Contents listing.
- .2 List subcontractor, supplier, and manufacturer, with name, address, and telephone number of responsible principal.
- .3 Except for items put into use with Owner's permission, leave the date of beginning of time of warranty until the Date of Substantial Performance is determined. The date of Substantial Performance of the Work shall be the date for commencement of the warranty period.
- .4 Verify that documents are in proper form, contain full information, and are notarized.
- .5 Co-execute submittals when required.
- .6 Retain warranties and bonds until time specified for submittals.

**END OF SECTION**

## **01 78 40 – Maintenance Requirements**

### **1.0 GENERAL**

#### **1.1. SECTION INCLUDES**

- .1 Equipment and systems.
- .2 Materials and finishes.
- .3 Spare parts
- .4 Maintenance manuals.
- .5 Special tools.
- .6 Storage, handling and protection.
- .7 This Section describes requirements applicable to all Sections within Divisions 02 to 49.

#### **1.2. RELATED SECTIONS**

- .1 Section 01 45 00 - Quality Control.
- .2 Section 01 78 40 – Maintenance Requirements.
- .3 This Section describes requirements applicable to all Sections within Divisions 02 to 49.

#### **1.3. EQUIPMENT AND SYSTEMS**

- .1 Each Item of Equipment and Each System: include description of unit or system, and component parts. Give function, normal operation characteristics, and limiting conditions. Include performance curves, with engineering data and tests, and complete
- .2 Panel board circuit directories: provide electrical service characteristics, controls, and communications.
- .3 Include installed colour coded wiring diagrams.
- .4 Operating Procedures: include start-up, break-in, and routine normal operating instructions and sequences. Include regulation, control, stopping, shut-down, and emergency instructions. Include summer, winter, and any special operating instructions.
- .5 Maintenance Requirements: include routine procedures and guide for trouble-shooting; disassembly, repair, and reassembly instructions; and alignment, adjusting, balancing, and checking instructions.
- .6 Provide servicing and lubrication schedule, and list of lubricants required.
- .7 Include manufacturer's printed operation and maintenance instructions.

- .8 Include sequence of operation by controls manufacturer.
- .9 Provide original manufacturer's parts list, illustrations, assembly drawings, and diagrams required for maintenance.
- .10 Provide installed control diagrams by controls manufacturer.
- .11 Provide coordination Drawings, with installed colour coded piping diagrams.
- .12 Provide charts of valve tag numbers, with location and function of each valve, keyed to flow and control diagrams.
- .13 Provide a list of original manufacturer's spare parts, current prices, and recommended quantities to be maintained in storage.
- .14 Include test and balancing reports as specified in Section 01 45 00.
- .15 Additional requirements: As specified in individual specification sections.

## **2.0 PRODUCTS**

### **2.1. MATERIALS AND FINISH**

- .1 Building Products, Applied Materials, and Finishes: include product data, with catalogue number, size, composition, and colour and texture designations.
- .2 Instructions for cleaning agents and methods, precautions against detrimental agents and methods, and recommended schedule for cleaning and maintenance.
- .3 Moisture-protection and Weather-exposed Products: include manufacturer's recommendations for cleaning agents and methods, precautions against detrimental agents and methods, and recommended schedule for cleaning and maintenance.
- .4 Building Envelope: include copies of drawings of building envelope components, illustrating the interface with similar or dissimilar items to provide an effective air, vapour and thermal barrier between indoor and outdoor environments. Include an outline of requirements for regular inspections and for regular maintenance to ensure that on-going performance of the building envelope will meet the initial building envelope criteria.
- .5 Additional Requirements: as specified in individual specifications sections.

### **2.2. SPARE PARTS**

- .1 Provide spare parts, in quantities specified in individual specification sections.
- .2 Provide items of same manufacture and quality as items in Work.
- .3 Receive and catalogue all items. Submit inventory listing to Consultant. Include approved listings in the Maintenance Manual.
- .4 Obtain receipt for delivered products and submit prior to final payment.

**2.3. MAINTENANCE MATERIALS**

- .1 Provide maintenance and extra materials, in quantities specified in individual specification sections.
- .2 Provide items of same manufacture and quality as items in Work.
- .3 Receive and catalogue all items. Submit inventory listing to Consultant. Include approved listings in the Maintenance Manual.
- .4 Obtain receipt for delivered products and submit prior to final payment.

**2.4. SPECIAL TOOLS**

- .1 Provide special tools, in quantities specified in the individual specification section.
- .2 Provide items with tags identifying their associated function and equipment.
- .3 Receive and catalogue all items. Submit inventory listing to Consultant. Include approved listings in the Maintenance Manual.

**3.0 EXECUTION**

**3.1. DELIVERY TO SITE**

- .1 Deliver to place of work and store.
- .2 General Contractor to receive and acknowledge delivery from contractors and subcontractors of all parts and materials assembled for maintenance requirements. Provide a summary inventory list to the Consultant and/or the Board after all materials are gathered and verification of location. Signatures of receipt will not be accepted from anyone except the General Contractor's representative.

**3.2. STORAGE, HANDLING AND PROTECTION**

- .1 Consult with the Board to determine location for storage.
- .2 Store spare parts, maintenance materials, and special tools in manner to prevent damage or deterioration.
- .3 Store in original and undamaged condition with manufacturer's seal and labels intact.
- .4 Store components subject to damage from weather in weatherproof enclosures.
- .5 Store paints and freezable materials in a heated and ventilated room.
- .6 Remove and replace damaged products at own expense and to the satisfaction of the Consultant.

**END OF SECTION**

## **01 79 00 – Demonstration and Training**

### **1.0 GENERAL**

#### **1.1. SECTION INCLUDES**

- .1 Procedures for demonstration and instruction of Products, equipment and systems to Owner's personnel.
- .2 Seminars and demonstrations.

#### **1.2. RELATED SECTIONS**

- .1 This section describes requirements applicable to all Sections within Divisions 02 to 49.

#### **1.3. DESCRIPTION**

- .1 At Substantial Performance, at a time acceptable to Owner and Consultant, but not before operations and maintenance manual have been reviewed and accepted by the consultant; contractor shall give a complete demonstration in the presence of consultant; Sub-consultants, Owner and Owner's personnel of operation and maintenance of systems and equipment once they are 100% complete.
- .2 Owner will provide a list of personnel to receive instructions and will coordinate their attendance at agreed-upon times.

#### **1.4. COMPONENT DEMONSTRATION**

- .1 Manufacturer to provide authorized representative to demonstrate operation of equipment and systems.
- .2 Instruct Owner's personnel, and provide written report that demonstration and instructions have been completed.

#### **1.5. SUBMITTALS**

- .1 Submit schedule of time and date for demonstration of each item of equipment and each system one (1) week prior to designated dates, for Consultant's approval.
- .2 Submit reports within forty eight (48) after completion of demonstration, that demonstration and instructions have been satisfactorily completed.
- .3 Give time and date of each demonstration, with a list of persons present.

## **1.6. CONDITIONS FOR DEMONSTRATIONS**

- .1 Equipment has been inspected and put into operation in accordance with manufacturer's instructions and contract requirements.
- .2 Testing, adjusting, and balancing have been performed in accordance with manufacturer's instructions and contract requirements, and equipment and systems are fully operational.
- .3 Provide information packages as required for use in demonstrations and instructions.

## **2.0 PRODUCTS**

### **2.1. NOT USED**

- .1 Not used.

## **3.0 EXECUTION**

### **3.1. PREPARATION**

- .1 Verify that suitable conditions for demonstration and instructions are available.
- .2 Verify that designated personnel are present.
- .3 Prepare agendas and outlines.
- .4 Establish seminar organization.
- .5 Explain component design and operational philosophy and strategy.
- .6 Develop equipment presentations.
- .7 Present system demonstrations.
- .8 Accept and respond to seminar and demonstration questions with appropriate answers.

### **3.2. PREPARATION OF AGENDAS AND OUTLINES**

- .1 Prepare agendas and outlines including the following:
  - .1 Equipment and systems to be included in seminar presentations.
  - .2 Name of companies and representatives presenting at seminars.
  - .3 Outline of each seminar's content.
  - .4 Time and date allocated to each system and item of equipment.
  - .5 Provide a separate agenda for each system.

### **3.3. SEMINAR ORGANIZATION**

- .1 Coordinate content and presentations for seminars.

- .2 Coordinate individual presentations and ensure representatives scheduled to present at seminars are in attendance.
- .3 Arrange for presentation leaders familiar with the design, operation, maintenance and troubleshooting of the equipment and systems. Where a single person is not familiar with all aspects of the equipment or system, arrange for specialists familiar with each aspect.
- .4 Coordinate proposed dates for seminars with Owner and select mutually agreeable dates.

### **3.4. EXPLANATION OF DESIGN STRATEGY**

- .1 Explain design philosophy of each system. Include following information:
  - .1 An overview of how the system is intended to operate.
  - .2 Description of design parameters, constraints and operational requirements.
  - .3 Description of system operation strategies.
  - .4 Information to help in identifying and troubleshooting system problems.

### **3.5. DEMONSTRATION AND INSTRUCTIONS**

- .1 Demonstrate start-up, operation, control, adjustment, trouble-shooting, servicing, and maintenance of each item of equipment.
- .2 Instruct personnel in all phases of operation and maintenance using operation and maintenance manuals as the basis of instruction.
- .3 Instruct personnel on control and maintenance of sensory equipment and operational equipment associated with maintaining energy efficiency and longevity of service.
- .4 Review contents of manual in detail to explain all aspects of operation and maintenance.
- .5 Prepare and insert additional data in operations and maintenance manuals when the need for additional data becomes apparent during instructions.

**END OF SECTION**

---

**PART 1 - GENERAL**

1.1 General

- .1 Conform to Division 01 - General Requirements.

1.2 Related Sections

- .1 Asbestos Audit Update.

1.3 Existing Conditions

- .1 Assume responsibility for demolition of structures in the condition they are at time notified of award of contract.
- .2 Inspect adjacent existing rooms and buildings to extent possible to ensure that its condition and stability is recorded in a manner suitable for evaluation of possible damage caused by work of this Section.

1.4 Designated Substances

- .1 Designated Substances to be removed prior to demolition by qualified trades following all regulatory requirements.

1.5 Work Included

- .1 Refer to Demolition Drawings for extent and scope of demolition work.

1.6 Protection

- .1 Demolition work shall be performed with adequate care being taken to prevent damage to surrounding work or material which is to remain the property of the Owner.
- .2 Prevent movement, settlement or damage of adjacent structures, services, existing elements to remain. Provide bracing, shoring, underpinning, as required. Make good all damage caused by demolition.
- .3 Take precautions to support affected structures, and if safety of building being demolished or adjacent structures or services appears to be endangered, cease operations and notify Consultant.
- .4 Prevent debris from blocking surface drainage system and mechanical and electrical systems which must remain in operation.
- .5 Provide protection from elements for all interior parts affected by demolition.
- .6 Fires and burning of waste or materials are not permitted.
- .7 Do not bury waste or materials on site.**
- .8 Do not dispose of waste or volatile materials such as: mineral spirits, oil, petroleum based lubricants, or toxic cleaning solutions into watercourses, storm or sanitary sewers. Ensure proper disposal procedures are maintained throughout project.
- .9 Do not pump water containing suspended materials into watercourses, storm or sanitary sewers, or onto adjacent properties.
- .10 Control disposal or runoff of water containing suspended materials or other harmful substances in accordance with local authorities.
- .11 Protect trees, plants and foliage on site and adjacent properties where indicated.
- .12 Prevent extraneous materials from contaminating air beyond application area, by providing temporary enclosures during demolition work.
- .13 Cover or wet down dry materials to prevent blowing dust and debris. Control dust on all temporary roads.



1.7 Scheduling of Work

- .1 Demolition of structure and appurtenances as indicated on the Drawings is to be undertaken at times and dates as directed by the Consultant or as otherwise listed in this Specification.
- .2 Cooperation with subcontractors is necessary to prevent delays.

1.8 Subcontractor Qualifications

- .1 Execute the work of this Section by a subcontractor who has adequate plant, equipment and skilled tradespeople to perform the work expeditiously and who is known to have been responsible for similar satisfactory work.
- .2 Performance of all demolition work shall be in accordance with all regulations under the Ministry of Labour, including the Occupational Health and Safety Act, Ministry of the Environment and the Ontario Building Code.

**PART 2 - PRODUCTS**

2.1 Equipment

- .1 Equipment and heavy machinery to meet or exceed all applicable emission requirements.
- .2 Leave machinery running only while in use, except where extreme temperatures prohibit shutting machinery down.

**PART 3 - EXECUTION**

3.1 Examination

- .1 Before commencing any demolition, ensure thorough examination of the site and work to be demolished so that all possible factors concerning demolition are investigated and that the following are known:
  - .1 Methods and means available for materials handling, disposal, storage and transportation.
  - .2 Construction of structures to be demolished.

3.2 Preparation

- .1 Install protection consisting of barricades, signs and substantial constructions to provide physical protection.
- .2 Erect shoring and other structures to prevent collapse, settlement and movement.
- .3 Post danger signs. Barricade all access by unauthorized persons to areas in which demolition is in progress.
- .4 Re-route electrical and mechanical services entering/ leaving the building and which are to be reconnected. Post warning signs and erect barricades on electrical lines and equipment which may remain energized to serve parts of the buildings during period of demolition. Refer to Drawings.
- .5 Do not disrupt active or energized utilities traversing premises.
- .6 Employ rodent and vermin control and comply with health regulations during any such control procedures.

3.3 General

- .1 Perform all demolition under the direction of a competent foreman at all times.
- .2 Water down debris frequently to prevent the spread of dust.
- .3 Provide for complete and safe access at all times to areas adjacent to demolition work.

3.4 Demolition

- .1 Demolish complete structures as indicated and remove existing equipments and services as indicated. Refer to Drawings. Contractors are required to view prior to Bidding.
- .2 Carefully remove materials and equipment, and store, protect, and reinstall in building, using qualified tradesmen those items designated in the specifications or on Drawings to be reinstalled.
- .3 Carefully remove materials and equipment to be retained by the Owner as indicated on Drawings. Refer also to Mechanical and Electrical Sections of the Specifications and Drawings for equipment to be handed over to the Owner.
- .4 At the end of each day's work, leave work in a safe condition so that no part is in danger of collapse or falling.
- .5 Demolish masonry and concrete walls in small sections. Carefully remove and lower structural framing and other heavy or large objects.
- .6 Stockpile materials in a location within the Project Area which will not impede demolition activity. Eliminate double handling where possible.
- .7 Selling or burning of materials on site is not permitted.

3.5 Disposal

- .1 Unless otherwise specified in this Section, remove completely from the site, all debris resulting from demolition.
- .2 Designate an area on site for the separation and storage of waste materials. Allow enough space for multiple bins.
- .3 At a minimum, provide storage bins onsite for concrete, metal, wood, cardboard, plastic, gypsum board and mixed waste. Land clearing debris, asphalt and concrete can be stockpiled onsite, for further processing.
- .4 Remove debris daily, or as it accumulates. Do not overload trucks, take means to prevent spillage.
- .5 Remove contaminated or dangerous materials from site and dispose of in a safe manner to minimize danger on site or at any time during disposal.

3.6 Clean Up

- .1 Upon completion of work, remove debris, trim surfaces and leave work site clean.
- .2 Use only cleaning solutions and procedures which are not harmful to health, are not injurious to plants, and do not endanger wildlife, adjacent watercourses or ground water.

END OF SECTION

## **PART 1 - GENERAL**

### 1.1 General

- .1 Conform to Division 01 – General Requirements.

### 1.2 Related Sections

- .1 Section 04 05 12 – Masonry Mortar and Grout.
- .2 Section 04 22 00 – Concrete Unit Masonry.
- .3 Section 07 92 00 – Joint Sealing.

### 1.3 References

- .1 Canadian Standards Association (CSA)
  - .1 CSA A179-14, Mortar and Grout for Unit Masonry.
  - .2 CSA-A371-14, Masonry Construction for Buildings.

### 1.4 Samples

- .1 Submit samples in accordance with Section 01 33 00 - Submittal Procedures.
- .2 Submit samples:
  - .1 Two of each type of masonry unit specified.
  - .2 One of each type of masonry accessory specified.
  - .3 One of each type of masonry reinforcement, tie and connector proposed for use.
  - .4 As required for testing purposes.

### 1.5 Test Reports

- .1 Submit laboratory test reports certifying compliance of masonry units and mortar ingredients with specification requirements.

### 1.6 Delivery, Storage and Handling

- .1 Deliver, store, handle and protect materials in accordance with Section 01 60 00 - Basic Product Requirements.
- .2 Deliver materials to job site in dry condition.
- .3 Keep materials dry until use except where wetting of bricks is specified.
- .4 Store under waterproof cover on pallets or plank platforms held off ground by means of plank or timber skids.
- .5 Note that there are restrictions for the new floors with respect to the type of equipment used to move materials and the weight of the materials being moved. Refer to Structural Drawings for additional details.

### 1.7 Environmental Requirements

- .1 Cold weather requirements:
  - .1 Supplement Clause 6.7.2 of CSA A371-14 with following requirements:
    - .1 Maintain temperature of mortar between 5°C and 50°C until batch is used.
  - .2 When air temperature is below 5°C the requirements for masonry construction shall be in accordance with CSA A371-14 Section 6.7.2.
  - .3 Maintain dry beds for masonry and use dry masonry units only. Do not wet masonry units in cold weather.
  - .4 Completed masonry or sections not being worked on shall be protected in accordance with CSA A371-14 Section 6.7.3.

- .2 Hot weather requirements to be in accordance with Clause 6.7.4 of a CSA A371-14:
  - .1 Protect freshly laid masonry from drying too rapidly, by means of waterproof, non-staining coverings.
  - .2 Keep masonry dry using waterproof, non-staining coverings that extend over walls and down sides sufficient to protect walls from wind driven rain, until masonry work is completed and protected by flashings or other permanent construction.

#### 1.8 Protection

- .1 Keep masonry dry using waterproof, non-staining coverings that extend over walls and down sides sufficient to protect walls from wind driven rain, until masonry work is completed and protected by flashings or other permanent construction.
- .2 Protect masonry and other work from marking and other damage. Protect completed work from mortar droppings. Use non-staining coverings.
- .3 Provide temporary bracing of masonry work during and after erection until permanent lateral support is in place.

### **PART 2 - PRODUCTS**

#### 2.1 Materials

- .1 Masonry materials are specified in related Sections indicated in 1.2.

### **PART 3 - EXECUTION**

#### 3.1 Installation

- .1 Do masonry work in accordance with CSA-A371 except where specified otherwise.
- .2 Build masonry plumb, level, and true to line, with vertical joints in alignment.
- .3 Layout coursing and bond to achieve correct coursing heights, and continuity of bond above and below openings, with minimum of cutting.

#### 3.2 Construction

- .1 Exposed masonry
  - .1 Remove chipped, cracked, and otherwise damaged units in exposed masonry and replace with undamaged units.
  - .2 Exposed block masonry to be reviewed upon application of first coat of paint.
- .2 Jointing
  - .1 Allow joints to set just enough to remove excess water, then tool with round jointer to provide smooth, joints true to line, compressed, uniformly concave joints where concave joints are indicated.
  - .2 Rake joints uniformly to 6mm depth and compress with square tool to provide smooth, compressed, raked joints of uniform depth where raked joints are indicated.
  - .3 Strike flush all joints concealed in walls and in walls to receive gypsum board, plaster, tile, insulation, stucco, or other applied material except paint or similar thin finish coating.
- .3 Joining of work
  - .1 Where necessary to temporarily stop horizontal runs of masonry, and in building corners:
    - .1 Step-back masonry diagonally to lowest course previously laid.
    - .2 Do not "tooth" new masonry.
    - .3 Fill in adjacent courses before heights of stepped masonry reach 1200mm.

- 
- .4 Cutting
    - .1 Cut out for electrical switches, outlet boxes, and other recessed or built-in objects.
    - .2 Make cuts straight, clean, and free from uneven edges.
  - .5 Building-In
    - .1 Build in items required to be built into masonry.
    - .2 Prevent displacement of built-in items during construction. Check plumb, location and alignment frequently, as work progresses.
    - .3 Brace door jambs to maintain plumb. Fill spaces between jambs and masonry with mortar.
  - .6 Wetting of bricks
    - .1 Except in cold weather, wet bricks having an initial rate of absorption exceeding 1 g/minute/1000 mm<sup>2</sup>: wet to uniform degree of saturation, 3 to 24 hours before laying, and do not lay until surface dry.
    - .2 Wet tops of walls built of bricks qualifying for wetting, when recommencing work on such walls.
  - .7 Support of loads
    - .1 Use concrete of strength(s) indicated in Section 03 30 00 - Cast-in-Place Concrete, where concrete fill is used in lieu of solid units.
    - .2 Use grout to CSA A179 where grout is used in lieu of solid units.
    - .3 Install building paper below voids to be filled with concrete or grout; keep paper 25mm back from faces of units.
  - .8 Provision for movement
    - .1 Except for walls designated as shear walls on the Structural Drawings, where no space for movement is to be provided;
      - .1 Leave 3mm space below shelf angles.
      - .2 Leave 6mm space between top of non-load bearing walls and partitions and structural elements. Do not use wedges.
    - .2 Build masonry to tie in with stabilizers, with provision for vertical movement.
  - .9 Loose steel lintels
    - .1 Install loose steel lintels at all openings greater than one masonry unit length. Centre over opening width; provide 200mm bearing each side.
  - .10 Control joints
    - .1 Except for walls designated as shear walls on the Structural Drawings, where no control joints are to be provided:
      - .1 Construct continuous control joints as indicated, and:
        - .1 at intersections of interior block walls with exterior block walls.
        - .2 at locations between walls on foundations and walls on thickened slabs
        - .3 over window and door jambs.
    - .2 Block reinforcement to be continuous at exterior control joints and at intersections of interior block walls with exterior block walls, non-continuous at interior control joints.
    - .3 Rake joints full height 10mm x 20mm and caulk to Section 07 92 00.
  - .11 Penetration of masonry
    - .1 Fill voids of masonry to within 19mm of structural members, pipes, ducts and conduit that penetrate masonry walls and partitions, unless otherwise indicated.
    - .2 Keep masonry units similarly clear of such penetrations.
    - .3 Finish mortar smooth at face of masonry.
    - .4 Pack remainder of annular void surrounding penetrating items with fire separation packing to within 12.7mm of face of masonry. Install sealant to maintain fire ratings where required.
  - .12 Adjustment and cleaning
    - .1 Patch damaged masonry walls which have been rejected.
    - .2 Point all holes in mortar joints except weepholes.

- .3 Point all voids in concrete unit masonry faces.
- .4 Cut out defective mortar joints to a minimum depth of 13mm and repoint.
- .5 Wash down and brush masonry to remove mortar and stains. Use only detergents, or proprietary masonry cleaners as recommended by masonry manufacturer.

3.3 Site Tolerances

- .1 Tolerances CSA A371-14 apply:
  - .1 Clause 6.2 for surfaces and lines;
  - .2 Clause 7.1.2.2. for bed joints below the first course of masonry;
  - .3 Clause 13.2.2. for width of air space in cavity and veneer systems.

END OF SECTION

## **PART 1 - GENERAL**

- 1.1 General
  - .1 Conform to Division 01 - General Requirements.
- 1.2 Related Sections
  - .1 Section 04 05 10 – Common Work Results for Masonry.
- 1.3 References
  - .1 Canadian Standards Association (CSA)
    - .1 CSA A179-14, Mortar and Grout for Unit Masonry.

## **PART 2 - PRODUCTS**

- 2.1 Materials
  - .1 Use same brands of materials and source of aggregate for entire project.
  - .2 Mortar and grout: CSA A179-14.
  - .3 Dirt resistant additives: Aluminum tristearate, calcium stearate or ammonium stearate.
  - .4 Use aggregate passing 1.18mm sieve where 6mm thick joints are indicated.
  - .5 All mortar to be prepared based on property specifications, as per CSA A179.
  - .6 Mortar for exterior masonry above grade:
    - .1 Loadbearing: Type S.
    - .2 Non-loadbearing: Type N.
    - .3 Parapet walls, chimneys, unprotected walls: Type S.
  - .7 Mortar for interior masonry:
    - .1 Loadbearing: Type S.
    - .2 Non-loadbearing: Type N.
  - .8 The following applies regardless of mortar types and uses specified above:
    - .1 Mortar for grouted reinforced masonry: Type S.
    - .2 Mortar for pointing: Type S.
  - .9 Non-staining mortar: use non-staining masonry cement for cementitious portion of specified mortar type.
  - .10 Type S mortar should be proportioned to meet the property specification minimum strength requirements but be less strength than the block strength of 20 MPa.
- 2.2 Mixes
  - .1 Colour and admixtures: Mix grout to semi-fluid consistency.
  - .2 Pointing mortar: Prehydrate pointing mortar by mixing ingredients dry, then mix again adding just enough water to produce damp unworkable mix that will retain its form when pressed into ball. Allow to stand for not less than 1 hour nor more than 2 hours then remix with sufficient water to produce mortar of proper consistency for pointing.

## **PART 3 - EXECUTION**

- 3.1 Construction
  - .1 Do masonry mortar and grout work in accordance with CSA A179 except where specified otherwise.

END OF SECTION

## **PART 1 - GENERAL**

- 1.1 General
  - .1 Conform to Division 01 – General Requirements.
- 1.2 Related Sections
  - .1 Section 04 05 10 – Common Work Results for Masonry.
  - .2 Section 04 05 12 – Masonry Mortar and Grout.
- 1.3 References
  - .1 A165 Series-04 CSA Standard on Concrete Masonry Units.

## **PART 2 - PRODUCTS**

- 2.1 Materials
  - .1 Standard concrete block units (CB): to CSA CAN3-A165.1 standards.
    - .1 Classification: H/15/A /M.
    - .2 Size: imperial.

## **PART 3 – EXECUTION**

- 3.1 Installation
  - .1 Concrete block units.
    - .1 Bond: running.
    - .2 Coursing height: 200mm +/- for one block and one joint.
    - .3 Jointing: concave where exposed or where paint or other finish coating is specified.
  - .2 When patching/ repairing openings existing walls, tooth-in concrete block using salvage block where possible or imperial block, **so that are no cut blocks left as a result of the repair. Match existing mortar joints, both in level and size.**
- 3.2 Cleaning
  - .1 Allow mortar droppings on masonry to partially dry then remove by means of trowel, followed by rubbing lightly with small piece of block and finally by brushing.

END OF SECTION



---

**PART 1 - GENERAL**

1.1 General

- .1 Conform to Division 01 – General Requirements.

1.2 Related Sections

- .1 Miscellaneous wood blocking, furring – Divisions 06, 07, 08, 09, 10.

1.3 References

- .1 Canadian Standards Association (CSA)
  - .1 CSA B111, Wire Nails, Spikes and Staples.
  - .2 CAN/CSA-G164-M, Hot Dip Galvanizing of Irregularly Shaped Articles.
  - .3 CSA O121-M, Douglas Fir Plywood.
  - .4 CAN/CSA-O141, Softwood Lumber.
  - .5 CSA O151-M, Canadian Softwood Plywood.
  - .6 CAN/CSA-O325.0, Construction Sheathing.
- .2 National Lumber Grades Authority (NLGA)
  - .1 Standard Grading Rules for Canadian Lumber.

1.4 Quality Assurance

- .1 Lumber identification: by grade stamp of an agency certified by Canadian Lumber Standards Accreditation Board.
- .2 Plywood identification: by grade mark in accordance with applicable CSA standards.
- .3 Plywood, OSB and wood based composite panel construction sheathing identification: by grademark in accordance with applicable CSA standards.

**PART 2 - PRODUCTS**

2.1 Lumber Material

- .1 Lumber: unless specified otherwise, SPF species softwood, S4S, moisture content 19% or less in accordance with following standards:
  - .1 CAN/CSA O141.
  - .2 NLGA Standard Grading Rules for Canadian Lumber.
- .2 Furring, blocking, nailing strips, grounds, rough bucks, cants, curbs, fascia backing and sleepers:
  - .1 S2S.
  - .2 Board sizes: "Standard" or better grade.
  - .3 Dimension sizes: "Standard" light framing or better grade.

2.2 Panel Materials

- .1 Panel standards: type, grade and thickness as indicated, in accordance with following standards:
  - .1 Douglas fir plywood (DFP): to CSA O121, standard construction, exterior grade.
  - .2 Canadian softwood plywood (CSP): to CSA O151, standard construction.
  - .3 Poplar plywood (PP): to CSA O153, standard construction.
  - .4 Waferboard and strandboard: to CAN3-O437.

---

2.3 Pressure Treated Lumber and Plywood

- .1 Pressure treated lumber: to CSA O80.1 - "Preservative Treatment of all Timber Products by Pressure Processes".

2.4 Fasteners

- .1 Nails, spikes and staples: to CSA B111.
- .2 Bolts: 12.7mm diameter unless indicated otherwise, complete with nuts and washers.
- .3 Proprietary fasteners: toggle bolts, expansion shields and lag bolts, screws and lead or inorganic fibre plugs, explosive actuated fastening devices, recommended for purpose by manufacturer.
- .4 Galvanizing: to CSA G164, use galvanized fasteners for exterior work, interior highly humid areas, and pressure-preservative treated lumber.

2.5 Accessories

- .1 Polyethylene film: to CAN 2-51.33 Type 1, 0.15mm thickness.

2.6 Wood Preservative

- .1 Surface applied wood preservative: copper naphthenate or 5% pentachlorophenol solution, water repellent preservative.

**PART 3 - EXECUTION**

3.1 Preparation

- .1 Treat surfaces of material with wood preservative, before installation.
- .2 Apply preservative by dipping, or by brush to completely saturate and maintain wet film on surface for minimum 3 minute soak on lumber and one minute soak on plywood.
- .3 Re-treat surfaces exposed by cutting, trimming or boring with liberal brush application of preservative before installation.
- .4 Treat material as indicated as follows:
  - .1 Wood cants, fascia backing, curbs, nailers, sleepers on roof deck.
  - .2 Wood furring for on outside surface of exterior masonry and concrete walls.

3.2 Installation

- .1 Comply with requirements of NBC, supplemented by the following paragraphs.
- .2 Install furring and blocking as required to space-out and support casework, cabinets, wall and ceiling finishes, facings, fascia, soffit, siding, washroom accessories and other work as required. Install required provisions for fastening located and secured to suit site conditions, and adequate for intended support.
- .3 Align and plumb faces of furring and blocking to tolerance of 1:600.
- .4 Install rough bucks, nailers and linings to rough openings as required to provide backing for frames and other work.
- .5 Except when indicated otherwise, use material at least 38mm thick and secured with 9mm bolts located within 300mm from ends of members and uniformly spaced at 1200mm between.

3.3 Erection

- .1 Frame, anchor, fasten, tie and brace members to provide necessary strength and rigidity.
- .2 Countersink bolts where necessary to provide clearance for other work.

3.4 Schedules

- .1 Provide electrical equipment backboards for mounting electrical equipment as indicated. Use 19mm thick plywood on 19mm x 38mm furring around perimeter and at maximum 300mm intermediate. Paint before installation.

END OF SECTION

---

**PART 1 - GENERAL**

1.1 General

- .1 Conform to Division 01, General Requirements.
- .2 REPORT IN WRITING TO THE WATERLOO REGION DISTRICT SCHOOL BOARD ANY DEFECTS OF SURFACES OR WORK PREPARED BY OTHER TRADES WHICH AFFECT THE QUALITY OR DIMENSIONS OF THIS CONTRACTOR'S WORK SHALL IMPLY COMPLETE ACCEPTANCE OF ALL WORK BY OTHER TRADES OR OF EXISTING ROOM CONDITIONS AND LOCATIONS.

1.2 Reference Standards

- .1 Standard of finished carpentry, metalwork and cabinet work in accordance with the "Millwork Standards" of the Architectural Woodwork Manufacturers Association of Canada (AWMAC).

1.3 Qualifications

- .1 The work of this trade shall be executed by a company having proven first class experience in this type of work and having adequate equipment and skilled personnel.

1.4 Work Included

- .1 Provide all millwork and casework as shown on the drawings, including but not limited to the following: provide prefinished cabinets, display cases, shelving units, counters, vanities, window sills, panelling, wood ceiling systems and similar items where shown on Drawings as specified herein, and as needed for a complete and proper installation.
- .2 Provision of rough hardware, including fastening devices required to secure in place items of carpentry and millwork.
- .3 Supply and installation of finishing hardware for millwork by this millwork contractor section 06 40 00.
- .4 Supply and installation of grilles, etc. on millwork items.
- .5 Installation of all miscellaneous metals for millwork items including but not limited to vanities.
- .6 Supply and installation miscellaneous trims, scribes, filler panels.
- .7 Provide cutouts in the counter tops for the sinks, electrical outlets and all other necessary cutouts regarding the millwork.

1.5 Shop Drawings

- .1 Shop drawings only required where not detailed by "AW" drawing. Copies of "AW" are to be marked up to indicate changes. "AW" drawings refer to WRDSB Millwork Standards drawings contained in Specifications/ Drawings.
- .2 Before shop drawings and fabrication is started, take critical measurements at the site to facilitate installation, fitting of work and access required to move millwork into final location. Take such measurements prior to fabrication of the work of this Section and in ample time to avoid delays in the work.
- .3 Draw Shop Drawings in related and/ or dimensional positions with sections. Scale minimum 1:10.
- .4 Shop Drawings shall show fabrication details, materials, jointing, description of anchorage and hardware.
- .5 Do not commence work until reviewed shop drawings have been returned as approved by Consultant and WRDSB.
- .6 The drawings are to be photocopied, confirmed, to fit openings and sizes, mark up, in red, and returned for approval.

1.6 Delivery and Storage

- .1 Give Painter sufficient notice so that untreated or unprimed carpentry items or materials can be primed immediately upon delivery to site.
- .2 No equipment shall be delivered to the site until portion of the building in which it is to be installed is completely ready for equipment as approved by Consultant.
- .3 Store finished work properly and keep under cover both in transit and at site. Finish woodwork shall not be delivered to site until concrete and masonry work has dried out.
- .4 Cover all plastic laminate and prefinished top surfaces at shop with heavy Kraft Paper.
- .5 Carefully protect from damage of any kind.

1.7 Related Sections

- .1 Section 06 10 10 – Rough Carpentry.
- .2 Section 09 21 16 – Gypsum Board Assemblies.
- .3 Section 09 91 10 – Painting.
- .4 Divisions 21-25 – Mechanical.
- .5 Divisions 26-28 – Electrical.

1.8 Shop Finish

- .1 All cabinet work, including wood all other cabinet trims, to be shop finished by this Section and per Section 09 91 10.

1.9 Samples

- .1 Samples melamine 305x305mm, plastic laminate, edging, hinges, pulls, bumpers, drawer slides, and shelf clip.
- .2 Submit duplicate 300mm long samples of each type of moulding.
- .3 Submit samples of construction methods and of all hardware.

1.10 Intent

- .1 The intent of this Section is that casework shall be manufactured and finished at the plant, delivered to the Site and immediately installed by this Section including provision of necessary strapping, backings, bearers, rough hardware and finish hardware and miscellaneous support metals and stainless steel metal components. Touch up finish immediately prior to completion of the Work and leave in perfect condition.

1.11 Cooperation

- .1 Water, drainage and air piping, faucets, hose cocks, retort rod and bases, traps, ventilation ducts, sinks, electric receptacles and wiring are supplied and installed by the Mechanical and Electrical Sections at all rooms. Coordinate the work with these trades and make provision in the construction of the fitments to accommodate this work. Methods of construction shall be such as to permit mechanical and electrical work being concealed in the fitments, cut and frame accordingly, provide removal access panels in the units or provide proper access for installation and repairs.
- .2 Cabinet hardware, pilaster strips, locks, finishing hardware will be supplied by this section. Miscellaneous metals used in this section will be supplied and installed by miscellaneous metals contractor unless otherwise noted.
- .3 Woodwork, not shop primed, will be primed and back painted as per painting section immediately upon delivery to the site. Care shall be taken that all surfaces cut after priming are brush coated with an approved primer before installation.

1.12 Maintenance

- .1 Provide Owner with printed instructions for "Care and Maintenance of Plastic Laminate" and millwork finishes.

1.13 Warranty

- .1 Warranty workmanship against manufacturing defects, including warpage or delamination, for a period of five (5) years from date of acceptance of the completed installation. Make good or replace work showing defects in this period, as requested, at no expense to the Owner.

**PART 2 - PRODUCTS**

2.1 Materials

- .1 Finishing Work: Materials used for finish work shall be sound, free from defects that would mar finished appearance, well seasoned and air dried and of good quality for intended purposes. Wood laminates pressure bonded.
- .2 Plywoods:
  - .1 Select Plain Sliced Maple Architectural Grade 'A' No. 1 Face grade; as in compliance with C.S.A. 0115-M1982 with a minimum 5 ply plywood veneer waterproof core, laminated with waterproof adhesive. Plywood shall be good both sides except where concealed by construction. Exposed faces to be natural grade per AWMAC. Interior of doors to be classified as exposed.
- .3 Melamine Faced Particleboard: to CAN3-0.188.1-M78, grade "H" particleboard sanded faces, 13mm, 16mm, 19mm, 28.6mm and 32mm thickness, faced with laminated plastic. Melamine resin impregnated cover sheet with coloured and/or patterned paper inner layer. Melamine shall be thermally fused to rigid particle board substrate. Melamine faces shall be 120 gram weight paper. Colour to be **Hardrock Maple**.
  - .1 Acceptable Material: Flakeboard, Uniboard or approved equal.
- .4 Particleboard: CSA-0118-1975 Type 11, Grade R, minimum 690 K8/m<sup>3</sup>, 4.5 to 8% moisture content.
- .5 Hardwood: shall be selected Hard White Maple, all shall be Architectural Grade (knots will not be accepted). It shall be selected for colours and graining when used for stain work.
- .6 Wood Edging: 6mm hardwood to match plywood unless indicated otherwise (if maple, use hard white maple).
- .7 Melamine Faced Particle Board Edge Banding: solid polyvinylchloride (PVC), 3mm thickness x full width of board, wood core, wood grain type or colour to match melamine face. Edging to be rigid PVC with a measured degree of hardness of "95 shore D" and thickness of "3mm (+0.15mm, -0.2mm)" with the primer side having a concave measuring 0.10 to 0.25mm.

Edging adhesive: ethylene vinylacetate thermalset adhesive with a temperature resistance of not less than 100°C; A Processing range of 190° - 200°C and natural in colour.

Edging is to be applied using only equipment designed for the application of thick PVC in strict accordance with the specifications of both the thick PVC and hot-melt adhesive manufactures. All edges and all corners of this 3mm PVC edgebanding are to be machined to a 3mm radius for all cabinet parts.

Care should be taken during application to achieve the thinnest glueline consistent with a good bond without causing skips or unspread areas. Final colour by Consultant.
- .8 Plywood Concealed by Construction: Douglas Fir plywood shall be veneer core, waterproof, bonded, sanded, complying with C.S.A. 0121-M1978. Solid grade where concealed by construction.

- .9 Concealed Framing Lumber: N.L.G.A.C. select eastern white pine, kiln dried to a 5% moisture content.
- .10 Unexposed Plywood for Framing: Waterproof fir plywood minimum 12.7mm thickness unless indicated otherwise.
- .11 Adhesive:
- .1 Waterproof synthetic resinous glue of approved general type conforming to CSA O112.
  - .2 For plastic laminate - as recommended by plastic laminate manufacturer and to conform to CSA O112.
  - .3 Approved waterproof type.
- .12 Plastic Laminate:
- .1 Laminated Plastic for Flatwork: 1.27mm thick decorative, melamine surfaced, high pressure laminated plastic sheeting in suede finish to conform to CAN3-A172-M79 (R1996) Grade G.P., Type 1. Manufacturer shall thoroughly sand back of sheet to form a homogeneous bonding surface. Plastic laminates shall be as manufactured by Arborite, Formica, Wilsonart or Nevamar. Backing sheet 0.5mm thick, sanded one side. Products may be selected based upon manufacturer's full standard range of colours and patterns. The finish will be suede; the colour will be non-stock.
  - .2 Laminated plastic for postforming work and preforming work: to CAN3-A172-M79 (R1996) Grade P.F., Type 3, 1.25mm thick, based on standard colours with suede finishes as selected by Consultant. Plastic laminates shall be as noted in 1. The colour will be non-stock.
- .13 PVC edging for plastic laminate work: solid polyvinylchloride (PVC), 3mm thickness x full width of board, colour to match plastic laminate face by Canada Wood tape or approved colour equal. Edging to be rigid PVC with a measured degree of hardness of "95 shore D" and thickness of "3mm (+0.15mm, -0.2mm)" with the primer side having a concave measuring 0.10 to 0.25mm.  
Edging adhesive Ethylene vinylacetate thermalset adhesive with a temperature resistance of not less than 100°C; A Processing range of 190° - 200°C and natural in colour.  
Edging is to be applied using only equipment designed for the application of thick PVC in strict accordance with the specifications of both the thick PVC and hot-melt adhesive manufactures. All edges and all corners of this 3mm PVC edgebanding are to be machined to a 3mm radius for all cabinet parts.
- .13 Cork: 6mm natural fine grain sheet cork. Cork to be Fabro from Architectural School Products or approved equal. Colour to be selected and approved. Fabric covering over cork, as indicated, to be supplied and installed by this section.
- .14 Nails and Staples: To C.S.A. Bill-1974. Use spiral threaded nails and barbed staples.
- .15 Architectural Woodwork Finish: Refer to Section 09 91 10.
- .16 Shelves: adjustable shelves longer than 950mm and fixed shelves without centre supports longer than 950mm to be 28.6mm thick wood veneer plywood or melamine faced particleboard as detailed. Shelves shorter than lengths specified above are to be 19mm thick wood veneer plywood core and melamine faced particleboard for alternate price items. Front edges of adjustable shelves to be edge-banded. Front edges of fixed shelves to edge banded, rear edge to be secured to cabinet back panel.
- .17 Exposed Fasteners: All millwork units secured to walls shall be secured with Tapcon screws and cup washers. All specialty fasteners such as acorn head bolts shall be supplied and installed by this section. Submit samples for Consultant's approval.
- .18 Countertops: to be plastic laminate postformed on particleboard or veneer core plywood or as noted on the Drawings. Adhesives: to CSA 0112.5M, waterproof type. Counter tops are postformed D profile.
- .19 Backer standard: to be 0.028 thick. Panels shown to have backer panel shall be balanced with 0.5mm backing sheet manufactured by the same manufacturer as the facing sheet. Core CSA O115-M1982 (R2001) (G/SO) or CSA O121-17 Grade "B" or CSA CAN3-O188.1-M78, Grade R.

## 2.2 Hardware

- .1 The cabinet work manufacturer shall furnish and install cabinet hardware. Finish of hardware shall be used US26D or US28 depending on base material. Hardware shall be manufactured as follows or approved equal:
  - .1 Pulls - door and drawer, Canadian Building Hardware CBH 255 x C26D.
  - .2 Hinges - Blum model 170BL91-653 with Blum mounting plate BL175.810 or approved equal, or specified other on Drawings. Or Hafela Aximat hinges self-closing 270° if noted on Drawings.
  - .3 Cabinet locks door and drawer - National # C8053-5 or approved equal. All cupboard doors in a room to be keyed the same. Each room to be keyed different. Provide 6 master keys for cupboard locks.
  - .4 Shelf support - Richelieu - # 5834-180 for 32mm spaced holes in all gables or recessed pilaster strips see drawings.
  - .5 Door Bumper - Richelieu # AMP5312-11.
  - .6 Elbow Catch - Richelieu # BP3675-2G.
  - .7 Drawer slides - Blum Metabox 320M integrated runner system using epoxy steel carcasses, adjustable front fixing brackets and 12mm Melamine with 3mm PVC on all exposed edges for bottoms and back panels. Install screws to all pre-drilled holes. Use deepest Metabox possible for space available or approved equal. See Drawings for other slides called for specific locations.
  - .8 Rough Hardware - Nails, screws, bolts, lag screws, anchors, special fastening devices and supports required for erection of carpentry components. Use galvanized components if exposed to exterior atmosphere. Galvanize in accordance with the requirements of CSAG164-M1981. Install all hardware to manufacturer specifications.
  - .9 Finishes: Melamine Composite Panels simulated Hard Rock Maple or as noted on the Drawings.  
Edge Banding: simulated Hardrock Maple grain or as noted on the Drawings
  - .10 Slide Bolts: Gallery 73 - 75mm or approved equal.
  - .11 Closet rod: Metal rod chrome 26mm dia. #122.108.140 and matching flanges #8332-140, by Richelieu
  - .12 Coat Hooks: Henkel Hook from Henkel Diversified Inc (519-641-5872).

## 2.3 Fabrication

- .1 General
  - .1 Fitments shall be machined, assembled in mill where possible and delivered to job in units. Construct in accordance with details using first class cabinet construction with joints dowelled, glued and properly fastened. Machine all surfaces of finished woodwork to an even smooth surface; fit all joints and miters accurately. Frame materials with tight joints held in place. Conceal joints and connections where possible. Joints made on site shall be equal in quality of work to joints made in the shop.
  - .2 Check job dimensions and conditions and notify the Consultant in writing of unacceptable conditions. Design construction methods for expansion. Do not proceed until remedial instructions are received.
  - .3 Deliver work to the job ready for installation. Leave ample allowance for fitting and scribing on the job. Shop assemble work for delivery to site in size easily handled and to ensure passage through building openings, Design units to fit together if site assembly is required.
  - .4 Fabricate work square and to the required lines. Recess and conceal fasteners and anchor heads. Fill with matching wood plugs.
  - .5 Comply with glue manufacturer's recommendations for lumber moisture content, glue life, pot life, working life, mixing spreading, assembly time, time under pressure and ambient temperature.



- .6 The interior of counters, cupboards, shelving units, desks, shall be considered "exposed". Finish all exposed edges with 3mm thick PVC edge banding material, applied by an Edge-Bander using Hot Melt adhesive. Colour to match the melamine. Radius all exposed edges and corners (PVC edging or Wood edging). Counter tops which are to receive plastic laminate coverings may be 3/4" (19mm) thick sanded veneer core plywood where specified. Particle core shall be used for shelving and gables, countertops specifically called for as solid material or as otherwise specified. Include all filler strips and to match the face colour.
- .7 Refer to Drawings and Architectural Detail Sheets for location, details, number of units required and location of fittings.
- .8 Interior fitments shall be complete in every respect with special fittings required and hardware.
- .9 Provide exposed end grain of solid members and edges of exposed plywood with matching solid hardwood edging at least 6mm thick and thicker where specified. At melamine faced particle board provide 3mm P.V.C. edging complete with 3 mm radius on all exposed edges and corners as per millwork sections. Edging to melamine faced particle board shall be applied with an Edge-Bander using hot melt adhesive.
- .10 Make all necessary cut-outs in the furniture for sinks, gas cocks, appliances, and electrical switch and outlet boxes and pre-drill all mounting holes for faucets, fittings and outlet boxes. Refer to electrical and mechanical drawings and specifications.
- .11 Provide and install pipe covers, scribing pieces, top, bottom and/or closures and filler panels where necessary, including wherever units require furring out or blocking to existing conduits, pipes, etc.
- .12 Service cover panels to be provided at all kneehole drawer units, kneehole front rails and knee drawer table assemblies. End closing panels to be provided at all exposed ends of service strips and island/peninsula assemblies. Front filler panels to be provided where called for on Drawings and as required by field conditions.
- .13 Telephone and electrical receptacles and wiring are specified under Electrical Division. Coordinate work of this trade, make provision to accommodate this work and cut tops for and provide wood bearers for support.
- .14 Cooperate with others engaged in work on the building to the end that proper unity of action will assure the orderly progress of the work. Do necessary boxing and protecting of sills, jambs, and the like. Construct scaffold, ramps, and other temporary staging necessary.
- .15 Provide 19mm plywood adjustable or fixed shelving where detailed. Maximum unsupported span for shelving shall be 900mm. Fixed shelves shall be dowelled into gables and divisions. Where shelves are set on clips only, gables shall be drilled 32mm o.c. for total height of gables.
- .16 The plywood used in interior fitments throughout regardless of whether for paint or stain finish, shall have exposed edges edged with solid strips 6mm wide, unless noted otherwise by full thickness of plywood. No exposed edges of plywood will be permitted. Strips shall be glued and accurately fixed to edges. Adjustable shelves shall have strips applied to front edge.
- .17 Exposed framing members and trim shall be solid hard maple.
- .18 Plastic laminate coverings to fitments, cupboards and counters shall be in colours selected by Consultant and applied in accordance with manufacturer's directions. Where plastic laminate occurs, exposed edges and edges around cut-outs such as sinks shall be edged in the same material. Seal remaining exposed edges of surfaces with heavy Kraft paper prior to shipment. Paper shall not be removed until final cleaning. When cutting holes in plastic laminate work, corners shall be rounded and filed smooth.
- .19 When cutting holes in plastic laminate work, corners shall be rounded and filed smooth.

- .20 Protection erected by this trade shall be removed, damage to this work and adjoining work due to the lack or failure of such protection, made good and debris, surplus materials, plant and equipment removed and premises and the whole left clean and tidy to Consultant's satisfaction.
- .21 Melamine on all surfaces unless noted otherwise.
- .22 Fabricate all plywood and melamine faced particle board backs, gables and bottoms of millwork units together by means of 8mm x 25mm hardwood dowels or with hardwood biscuits. All backs to be 12.7mm stock. Dowel all panel cabinet components using 5mm x 25mm hardwood dowels or biscuits at maximum 100mm o.c. All drawer bottoms and backs are 12.7mm stock or greater. All exposed edges on all melamine faced particle board units to be edged with solid 3mm PVC C/W 3mm radius edges and corners including drawer parts and with 6mm matching hardwood edge banding at Maple and Birch units. Kick material for normal application shall be 19mm waterproof spruce/fir plywood to be used. Resilient base by Section 09 65 16 and porcelain tile base by Section 09 30 15.
- .2 Cupboard Doors
  - .1 Doors shall be 19mm thick particle core veneer plywood. Doors shall be flush, slab type, accurately fitted, free of warp and twist. Care must be taken in sawing and assembling so that there is no splintering of finish face. Splintered doors that mar the appearance will be rejected by the Consultant.
  - .2 Where melamine is specified; construct doors of 19mm particle core with melamine good - 2 sides.
  - .3 Provide two door silencers/bumpers per panel mechanically fastened to the cabinet frames.
- .3 Drawers
  - .1 Fabricate Blum Metabox drawer bottom and backs with 16mm melamine composite panel.
  - .2 Where melamine is specified: drawer fronts to be 19mm particle core with melamine, good 2 sides.
  - .3 Extend all backs in file drawers for use with hanging file hardware. Metabox units used should also allow for legal width hanging folders to run front to back and letter width side to side where space permits.
  - .4 Fronts to match cupboard doors finish.
  - .5 Provide two drawer silencers/bumpers per drawer panel mechanically fastened to the cabinet frame.
- .4 Counters, Cupboards, Shelving etc.
  - .1 Adjustable shelves c/w clips and drilled holes at 32mm centers. Base cabinets c/w 1 shelf, wall cabinet's c/w 2 shelves, and tall cabinet's c/w 5 shelves, the centre shelf is fixed unless Drawings show otherwise. Factory install all hardware firmly into position for long life under hard use. Install 2 hinges on doors up to 1 metre in height, 3 hinges to 1.5 metre in height and 4 hinges for doors greater than 1.5 metres in height or shown otherwise.
  - .2 Frame as detailed with 19mm thick, or as noted otherwise, plywood gables, tops and bottoms. House intermediate dividers and plywood backs, into gables and top and bottom shelves, for all fitments. Plywood shall be birch or oak as called for in this Section unless otherwise indicated. Cabinet backs to be 12.7mm plywood.
  - .3 Where melamine specified: horizontal and vertical gables; and shelving to be 19mm particle core with melamine, good 2 sides. Cabinet backs to be 13mm particle core with melamine, good 1 side.
  - .4 Fabricate cabinet carcass, the 32-millimeter system from 19mm thick melamine composite panel using flush frameless construction and exposed edges, to AWMAC Standard " Custom grade" c/w 3mm thick PVC edge banding on exposed edges. All exposed edge banding c/w 3mm radiuses edges and corners. Do not exceed 800mm a maximum width of cabinet without a divider or specified otherwise.

- Carcass construction- Backs 16mm, bottoms, rails, doors, drawer fronts 19mm of melamine composite panels, assembled with glued hardwood dowels 8x30mm or wafers.
- .5 Cut countertops for sinks and provide bearers. Provide backsplash at back of sink for entire length of the unit and at return ends where walls or other vertical surface occur within 600mm of sink or other wet location.
  - .6 Countertop and backsplash will be plastic laminate unless noted otherwise.
  - .7 Provide removable plywood access panels, screwed in place, where necessary for access to concealed wiring.
  - .8 Fit trim and scribe moulds to fitments as shown and as required to hide voids at walls, partitions and ceilings.
  - .9 Provide cut-outs for inserts, outlets, grilles, appliances, etc. occurring in fitments.
  - .10 Bottom of units blocked up to form a 100mm high x 75mm deep toe space and fabricated from 19mm waterproof veneer core plywood of fir or spruce
  - .11 Fit fillers between fitments, of same material as fitments, where necessary to fill voids between fitments and walls.
  - .12 Lighting fixtures and outlets to be supplied and installed under Division 26.
  - .13 Provide cutouts and access panels where required for Divisions 22-23 and covers over ductwork (stove exhaust fans) or piping that run exposed above counters and upper shelves.
  - .14 Provide extended top, bottom, and exposed gables where furring out of upper cupboards is required due to pipes, conduits, and the like behind to provide a flush face at walls.
  - .15 Plastic Laminate Work:
    - .1 Comply with CAN3-A172-M79, Appendix "A".
    - .2 Veneer laminated plastic to core material in accordance with adhesive manufacturer's instructions. Ensure core and laminate profiles coincide to provide continuous support and bond over entire surface. Provide cores of not less than 19mm nominal thickness solid face Douglas Fir.
    - .3 Form shaped profiles and bends as indicated, using postforming grade laminate to laminate manufacturer's instructions.
    - .4 Use straight self-edging laminate strip 1.6mm thick for flatwork to cover exposed edge of core material. Chamfer exposed edges uniformly at approximately 20°. Do not mitre laminate edges. Curved self edging shall be postformed material or bending grade.
    - .5 Apply laminate backing sheet to reverse side of core of plastic laminate work where specified. Provide backing sheet of sufficient thickness to compensate for stresses caused by the facing sheet.
    - .6 Locate joints where indicated, where not indicated at approximately 2440mm or 3660mm centres also include joints at corners, and changes in superficial area.
    - .7 Accurately fit decorative laminate together to provide tight, flush, butt joints. Joints in cored panels shall be made with 6mm blind splines and draw bolts, one draw bolt for widths up to 150mm two or more draw bolts at maximum 450mm o.c. for widths exceeding 150mm.
    - .8 Keep joints min. 600mm from sink cutouts.
    - .9 Seal the core at joints and exposed edges with sealer.
    - .10 Counter tops apply Tremco Tremsil 200 silicone sealant at junction of plastic laminate or phenolic tops when tops are joined. All joints to be over a gable or supported otherwise.
    - .11 Use draw bolts in counter top joints.
    - .12 Apply a small bead of mildew-resistant paintable silicone sealant at junction of plastic laminate counter back and adjacent wall finish.

---

### **PART 3 - EXECUTION**

#### 3.1 Workmanship

- .1 Fabricate and install work in accordance with the best practice. Finished work shall be free from drag, feathers, splinters or roughness of any kind. Remove machine marks by sanding. Give finished work smooth surfaces, ready for painting or varnish application.
- .2 Mortise and tenon joints shall be glued and pinned. All panels shall be secured together with specified glued and dowelled method. Glue blind screw all fabricated component work unless otherwise specified. Set surface nails and plug countersunk screws with matching wood plugs. Use screws with cap washers where units with doors are secured to walls behind.
- .3 Finished woodwork shall be free from bruises, blemishes, mineral marks, knots, shakes and other defects.
- .4 All metal items such as grilles, tracks, supports, legs, brackets, etc. supplied by other trades shall be built into fitments, panelling, wood doors, etc., in strict accordance with directions of trades supplying such.
- .5 Furnish rough hardware, nails, expansion shields, screws, brackets and incidentals required to assemble and install the fitments in their proper locations.
- .6 Fit small scribe moulds or fillers of same materials as fitment to hide or fill voids at walls, partitions ceilings, furrings, exposed tops of millwork units, at base locations where rubber base occurs.
- .7 Plywood Edging: all exposed 19mm plywood edges shall be covered with glued on 6mm thick hardwood strips.

#### 3.2 Millwork Workmanship

- .1 Fitments shall have joints dowelled and all joints shall be glued and nailed or screwed. All cabinet bases shall be of 19mm plywood, blocked at 900mm O.C. maximum and at corners.
- .2 Counter tops shall have splash backs where sinks occur.
- .3 Shelving shall be 19mm plywood, adjustable or fixed as detailed. Maximum unsupported span for shelving shall be 900mm. Adjustable shelves shall be set on angle clips or metal pilaster strips. Loose shelves shall have PVC edges on front edge.
- .4 Laminates shall be pressure bonded to back-up board. Counter tops shall be self edged and have plastic laminate covered back splash. Back-up material for counter tops shall be particle core unless otherwise noted.
- .5 Plastic laminate surface shall be level, without bubbles and core ghosting. Core edges in counter cut outs shall be sealed with asphalt compound. All exposed plastic edges shall be matched and sanded.

#### 3.3 Installation

- .1 Commencement of work implies total acceptance of surface and site conditions.
- .2 Set and secure all materials and components in place, rigid plumb and square.
- .3 Provide all furring strips and strapping required fixing millwork and casework to walls, etc.
- .4 Provide all filler strips to seal any openings or joints at adjacent surfaces.
- .5 After installation, fit and adjust operating hardware to align all doors and drawers.
- .6 Clean up as the work proceeds and upon completion remove all rubbish and surplus materials resulting from the foregoing work.
- .7 Plumbing
  - .1 Sink installation:
    - .1 Cut hole, clean the counter top with alcohol.
    - .2 Use Tremco, Tremsil #200 a silicone sealant that gives protection against fungi and bacteria.

- .3 Install Tremsil around the cuts, and then place a bead of Tremsil on the top before installing the sink.
- .4 Millwork Contractor to ensure the Plumber installs as specified.
- .8 Installation and assembly work on the job shall be executed by skilled forces under supervision of a competent joinery foreman.
- .9 Furnish rough hardware, nails, expansion shields, screws, brackets and incidentals required to assemble and install fitments in proper locations. Units shall be adequately fastened and secured in place with concealed fixings wherever possible. Include grounds and furring where required.
- .10 Fitments shall be installed level, plumb and true and complete in all respects.
- .11 Provide smooth surfaces with fastenings sunk and filled over to receive stain and sealer.
- .12 Use draw bolts in countertop joints.
- .13 At junction of plastic laminate counter, back splash and adjacent wall finish, apply small bead of silicone sealant as per Section 07 92 10 in colour as selected by Consultant.
- .14 Apply water resistant building paper over wood framing members in contact with masonry or cementitious construction.

#### 3.4 Hardware Installation

- .1 Locate concealed European style hinges in accordance with manufacturer of hinge and with best standard practice. Set knobs, locks, and cylinders square with doors and escutcheons plumb. Apply accurately and neatly, to operate quietly and smoothly. Knobs shall turn easily, bolts slide freely and smoothly.
- .2 All cupboard doors and drawer locks except as noted below, shall be keyed alike in each room unless otherwise stated. All such keys shall be labelled as to their lock location and shall be turned over to the Owner. All locks, slide bolts, etc. shall be supplied with the appropriate strikes and screws. Provide slide bolts at all locked pair of doors on interior side of door leaf without lock.  
NOTE: No locks on doors below sink units.
- .3 All pilaster strips, where specified, shall be recess mounted and installed with the numbers on the pilaster at equal heights.
- .4 At completion of the work, moving parts shall be gone over, made to work easily, smoothly and efficiently. Work carefully cleaned down and left in complete and finished condition satisfactory to Consultant.

#### 3.5 Resilient Base

- .1 Supply and installation of resilient base at millwork units as indicated is by Section 09 65 16 for rubber base locations.

END OF SECTION

**MILLWORK MATERIAL LEGEND:**

- 1 DISPLAY CASE
- 2 100 HIGH RUBBER BASE TOE KICK ON 19 VENEER CORE PLYWOOD
- 3 19mm MELAMINE PANEL OPEN STORAGE c/w 5 ADJUSTABLE SHELVES
- 4 19mm MELAMINE PANEL DRAWER FRONT c/w 3mm PVC EDGES. REFER TO SPEC FOR DRAWER SLIDERS AND DRAWER CONSTRUCTION (METABOX)
- 5 19mm MELAMINE GABLE PANEL c/w 3mm PVC ON ALL EXPOSED EDGES AND PIN HOLES FOR 19mm ADJUSTABLE SHELVES AS SHOWN
- 6 19mm MELAMINE PANEL BANK OF 4 DRAWERS
- 7 POST FORMED PLASTIC LAMINATE COUNTERTOP c/w 76 HIGH BACKSPLASH ON STOCK
- 8 GYPSUM BOARD BULKHEAD
- 9 19mm MELAMINE PANEL UPPER CABINETS c/w FINISHED END GABLES WHERE REQUIRED AND ADJUSTABLE SHELVES AS SHOWN
- 10 80 HIGH MELAMINE PANEL VALANCE x 19mm
- 11 STAINLESS STEEL SINK, REFER TO MECHANICAL DRAWINGS
- 12 PLASTIC LAMINATE SEPARATE BACKSPLASH ON 19mm PLYWOOD
- 13 19mm MELAMINE COUNTERTOP C/W 3mm PVC ON ALL EXPOSED EDGES AND BETWEEN BUTT JOINT EDGES
- 14 DISHWASHER
- 15 19mm MELAMINE ADJUSTABLE SHELF WITH 3mm PVC EDGES
- 16 16mm MELAMINE BACK c/w 3mm PVC EDGE WHERE EXPOSED
- 17 19mm MELAMINE TOP, BOTTOM c/w 3mm PVC EDGE
- 18 ENAMELLED STEEL VANITY LAVATORY
- 19 LOCKABLE CASTERS REFER TO SPEC.
- 20 PLASTIC LAMINATE POST FORMED WORKSURFACE ON MELAMINE PANEL INTERMEDIATE GABLES
- 21 PLASTIC LAMINATE POST FORMED COUNTERTOP AND MELAMINE PANEL OPEN STORAGE c/w FINISHED GABLE END WHERE REQUIRED AND ADJUSTABLE SHELVES AS SHOWN
- 22 19mm MELAMINE FIXED SHELF c/w 3mm PVC EDGE
- 23 19mm MELAMINE DOOR c/w 3mm PVC EDGE ON ALL EXPOSED EDGES
- 24 19mm MELAMINE PANEL c/w 3mm PVC EDGE ON ALL EXPOSED EDGES
- 25 16mm MELAMINE PANEL c/w 3mm PVC EDGE ON ALL EXPOSED EDGES FRAME
- 26 16mm FIXED MELAMINE PANEL/SHELF c/w 3mm PVC EDGE ON ALL EXPOSED EDGES
- 27 PLASTIC LAMINATE POST FORMED COUNTERTOP AND MELAMINE PANEL GABLES
- 28 PLASTIC LAMINATE ON 19mm PLYWOOD
- 29 25mm MELAMINE WITH PVC EDGE AT FRONT FACE AND EACH FACE OF THE JOINTS IN THE COUNTER TOP
- 30 38mm X 89mm SOLID HARDWOOD SUPPORT
- 31 SINGLE 19mm MELAMINE GABLE C/W 1/8" PVC EDGE
- 32 TRIPLE 19mm MELAMINE GABLE SUPPORT C/W 3mm PVC EDGE ON FRONT AND FLOOR EDGE AT APPROX. 910mm O.C. MAX. WAFER AND SCREW TOGETHER.
- 33 ADJUSTABLE FEET SEE SPEC.
- 34 51mm X 102mm OR 19mm PLYWOOD CONTINUOUS BLOCKING ON WALL, PROVIDE WOOD BLOCKING AT ALL EDGE END WAL CONDITIONS.
- 35 19mm HARDWOOD SCREW STRIP BETWEEN MELAMINE GABLES.
- 36 PLYWOOD PANEL FILLER 19mm
- 37 19mm VENEER CORE PLYWOOD CONTINUOUS JOINTS TO BE AT GABLE LOCATIONS.
- 38 LINEAR GRILLE, REFER TO SPECIFICATIONS

N:\Projects\1065 WRDSB Small Projects 2022-2023\1065G - Waterloo-Oxford District Secondary School\DRAWINGS\TECHNICAL\1065G-MILLWORK.dwg, 2024 Feb 15, 03:03 pm  
 2024-03-22 ISSUED FOR OWNER REVIEW

# Waterloo-Oxford District Secondary School

FAMILY STUDIES RENOVATION & HVAC UPGRADES 1206 Snyder's Rd. W, New Hamburg, ON

Project No.:

1065G

## MILLWORK MATERIAL LEGEND

Plot Date:

2024-2-15

**CORNERSTONE**  
ARCHITECTURE

110-700 Richmond St. London ON Canada N6A 5C7  
P 519 432 6644 F 519 432 6737

cornerstonearchitecture.ca

© 2024 Cornerstone Architecture Incorporated. All Rights Reserved.

**AW001**

N:\Projects\1065 WRDSB Small Projects 2022-2023\1065G - Waterloo-Oxford District Secondary School\DRAWINGS\TECHNICAL\1065G-MILLWORK.dwg, 2024 Feb 15, 03:06 pm

2024-03-22 ISSUED FOR OWNER REVIEW

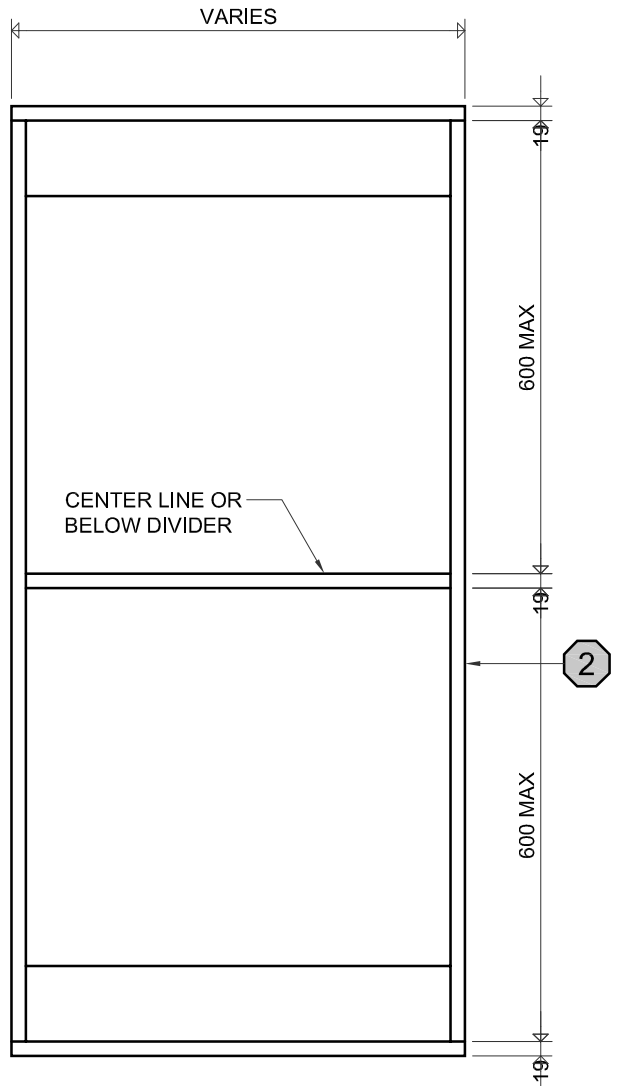
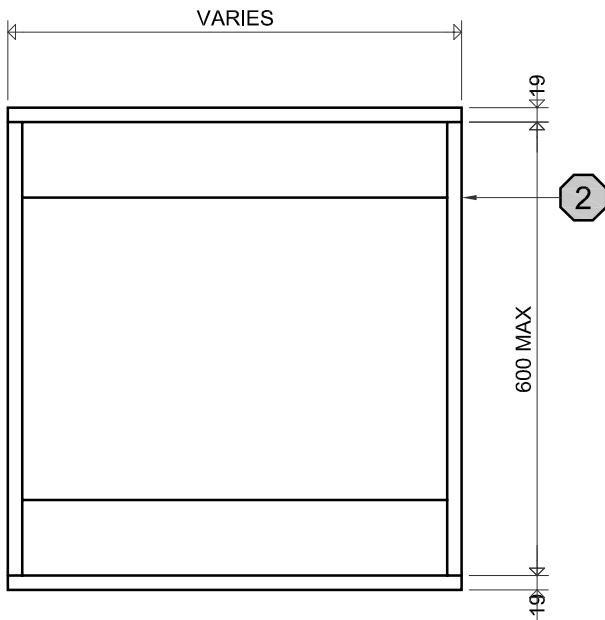
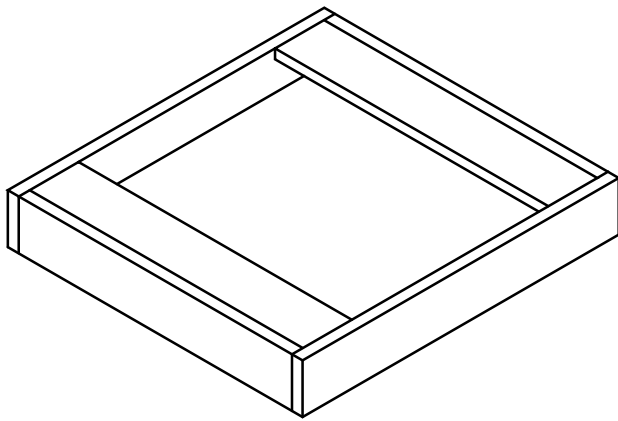

1  
AW004

### TYPICAL TOE KICK DETAIL

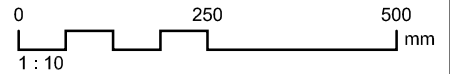

# Waterloo-Oxford District Secondary School

FAMILY STUDIES RENOVATION & HVAC UPGRADES 1206 Snyder's Rd. W, New Hamburg, ON

Project No.:

1065G

## TYPICAL TOE KICK DETAIL

Plot Date:

2024-2-15

# CORNERSTONE

ARCHITECTURE

110-700 Richmond St. London ON Canada N6A 5C7  
P 519 432 6644 F 519 432 6737

cornerstonearchitecture.ca

© 2024 Cornerstone Architecture Incorporated. All Rights Reserved.

# AW004

N:\Projects\1065 WRDSB Small Projects 2022-2023\1065G - Waterloo-Oxford District Secondary School\DRAWINGS\TECHNICAL\1065G-MILLWORK.dwg, 2024 Feb 15, 03:11 pm

2024-03-22 ISSUED FOR OWNER REVIEW

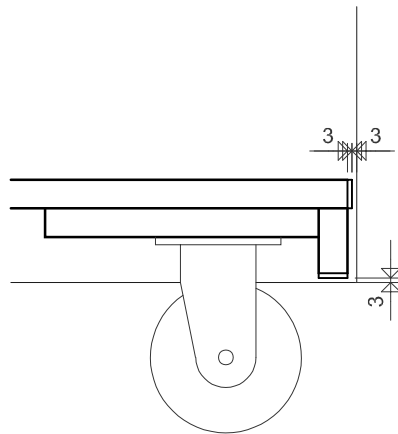
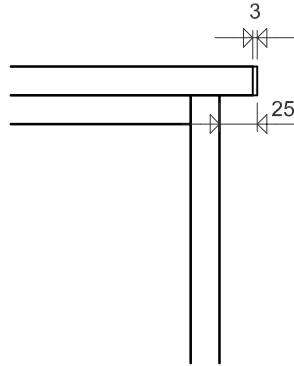

1  
AW006

## SECTION DETAIL

0 50 200mm  
1:5

# Waterloo-Oxford District Secondary School

FAMILY STUDIES RENOVATION & HVAC UPGRADES 1206 Snyder's Rd. W, New Hamburg, ON

Project No.:

1065G

## TYPICAL DETAILS

Plot Date:

2024-2-15

**CORNERSTONE**  
ARCHITECTURE

110-700 Richmond St. London ON Canada N6A 5C7  
P 519 432 6644 F 519 432 6737

cornerstonearchitecture.ca

AW006

© 2024 Cornerstone Architecture Incorporated. All Rights Reserved.



N:\Projects\1065 WRDSB Small Projects 2022-2023\1065G - Waterloo-Oxford District Secondary School\DRAWINGS\TECHNICAL\1065G-MILL\WORK.dwg, 2024 Feb 15, 03:00 pm

2024-03-22 ISSUED FOR OWNER REVIEW

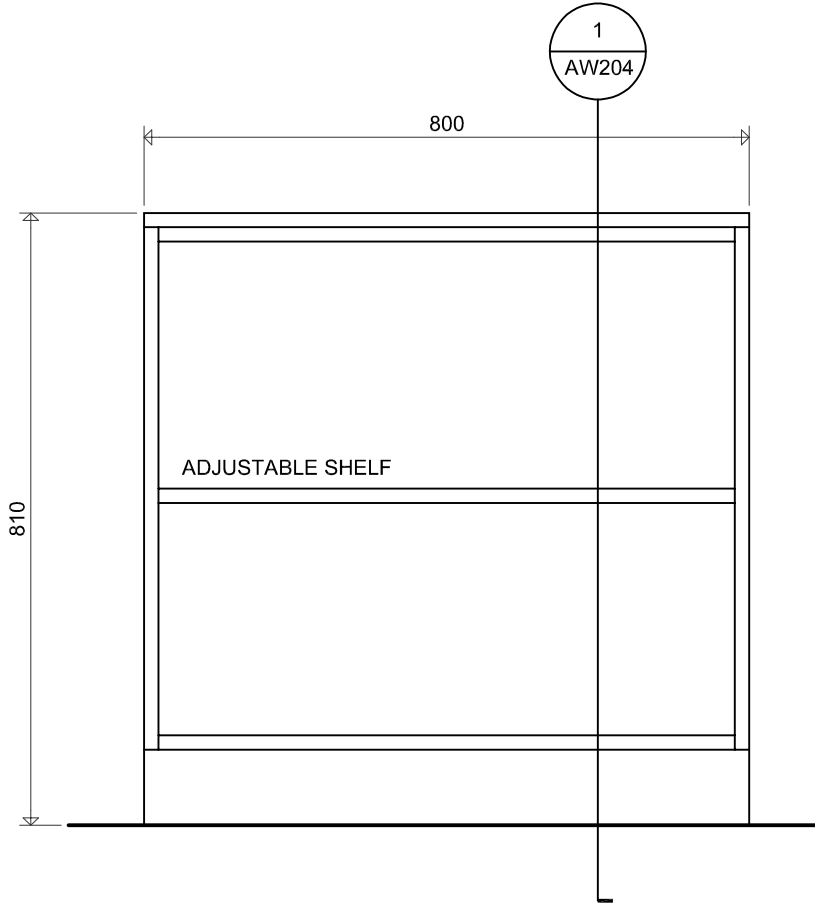

1  
AW201

### ELEVATION

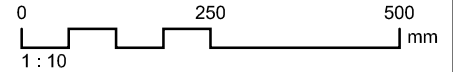

# Waterloo-Oxford District Secondary School

FAMILY STUDIES RENOVATION & HVAC UPGRADES 1206 Snyder's Rd. W, New Hamburg, ON

Project No.:

1065G

## LOW BOOKSHELF - 810mm - ELEVATION

Plot Date:

2024-2-15

**CORNERSTONE**  
ARCHITECTURE

110-700 Richmond St. London ON Canada N6A 5C7  
P 519 432 6644 F 519 432 6737

cornerstonearchitecture.ca

© 2024 Cornerstone Architecture Incorporated. All Rights Reserved.

AW201

N:\Projects\1065 WRDSB Small Projects 2022-2023\1065G - Waterloo-Oxford District Secondary School\DRAWINGS\TECHNICAL\1065G-MILL\WORK.dwg, 2024 Feb 15, 03:01 pm

2024-03-22 ISSUED FOR OWNER REVIEW

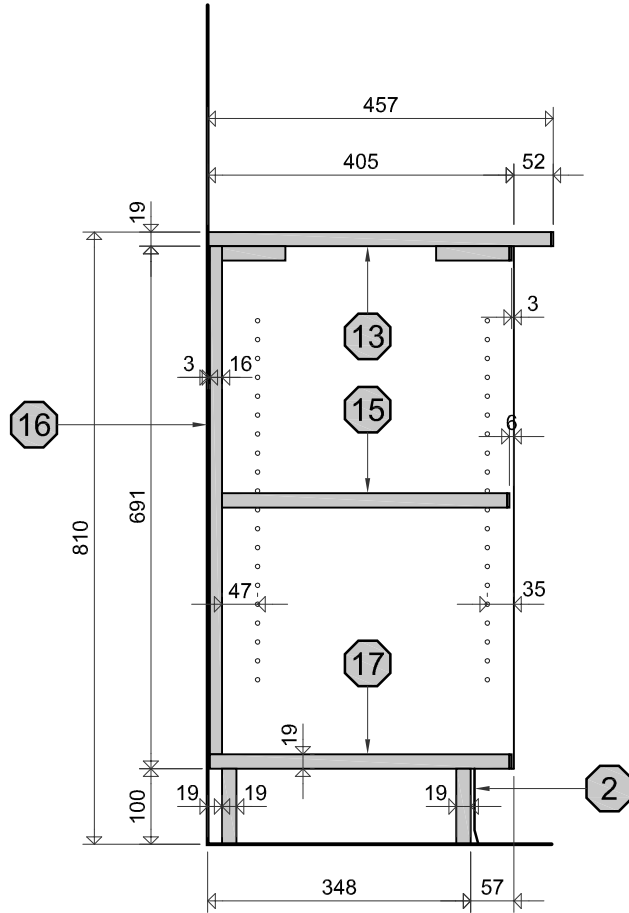

1  
AW204

# SECTION

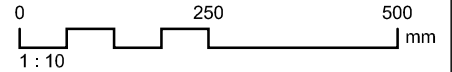

## Waterloo-Oxford District Secondary School

FAMILY STUDIES RENOVATION & HVAC UPGRADES 1206 Snyder's Rd. W, New Hamburg, ON

Project No.:  
1065G

### LOW BOOKSHELF - 810 - SECTION

Plot Date:  
2024-2-15

**CORNERSTONE**  
ARCHITECTURE

110-700 Richmond St. London ON Canada N6A 5C7  
P 519 432 6644 F 519 432 6737

cornerstonearchitecture.ca

© 2024 Cornerstone Architecture Incorporated. All Rights Reserved.

AW204

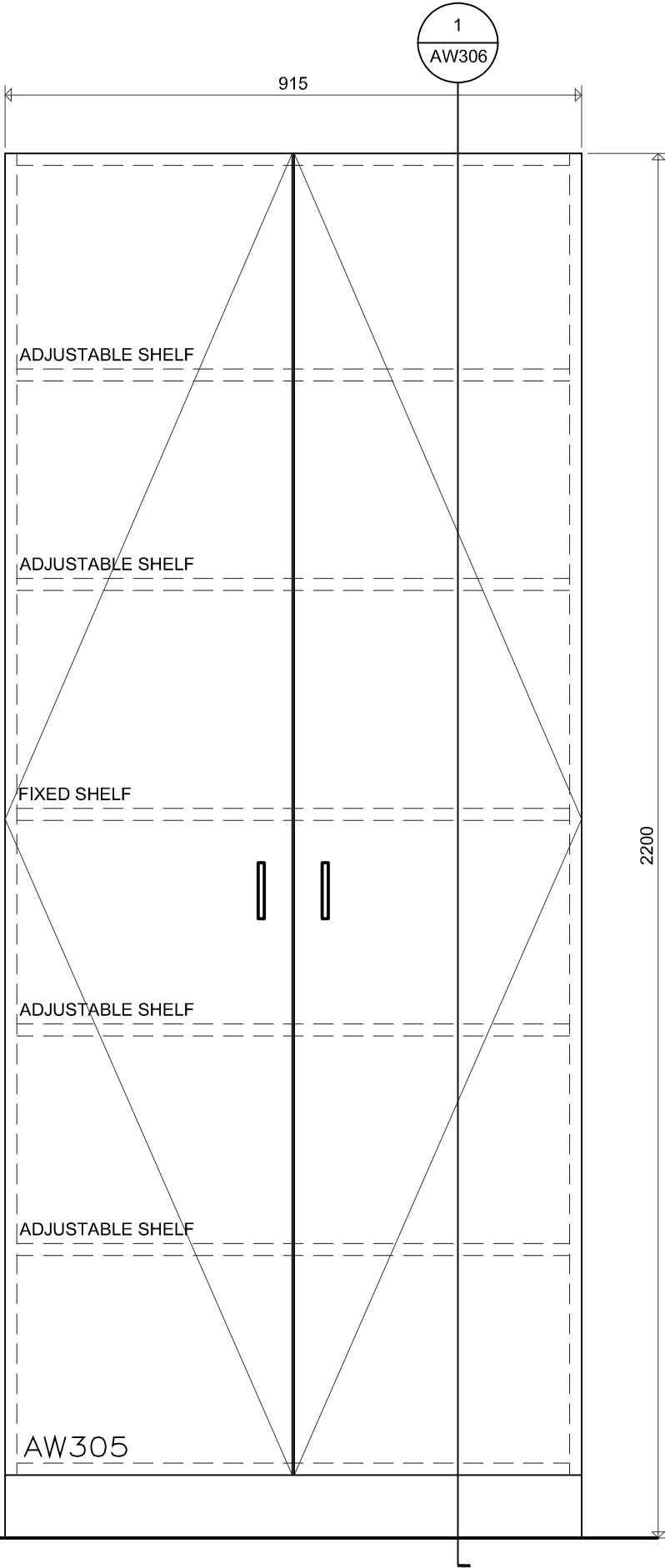

**ELEVATION**

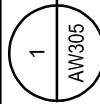

**Waterloo-Oxford District Secondary School**

Family Studies Renovation & HVAC Upgrades 1206 Snyder's Rd W, New Hamburg, ON N3A 1A4

**TEACHERS CLOSETS - TYPE 3 - 2 DOORS - ELEVATION**

Project No.:  
**1065G**

Plot Date:  
2024-03-26

**AW305**

**CORNERSTONE**  
ARCHITECTURE

110-700 Richmond St. London ON Canada N6A 5C7  
P 519 432 6644 F 519 432 6737  
cornerstonearchitecture.ca

© 2024 Cornerstone Architecture Incorporated. All Rights Reserved.

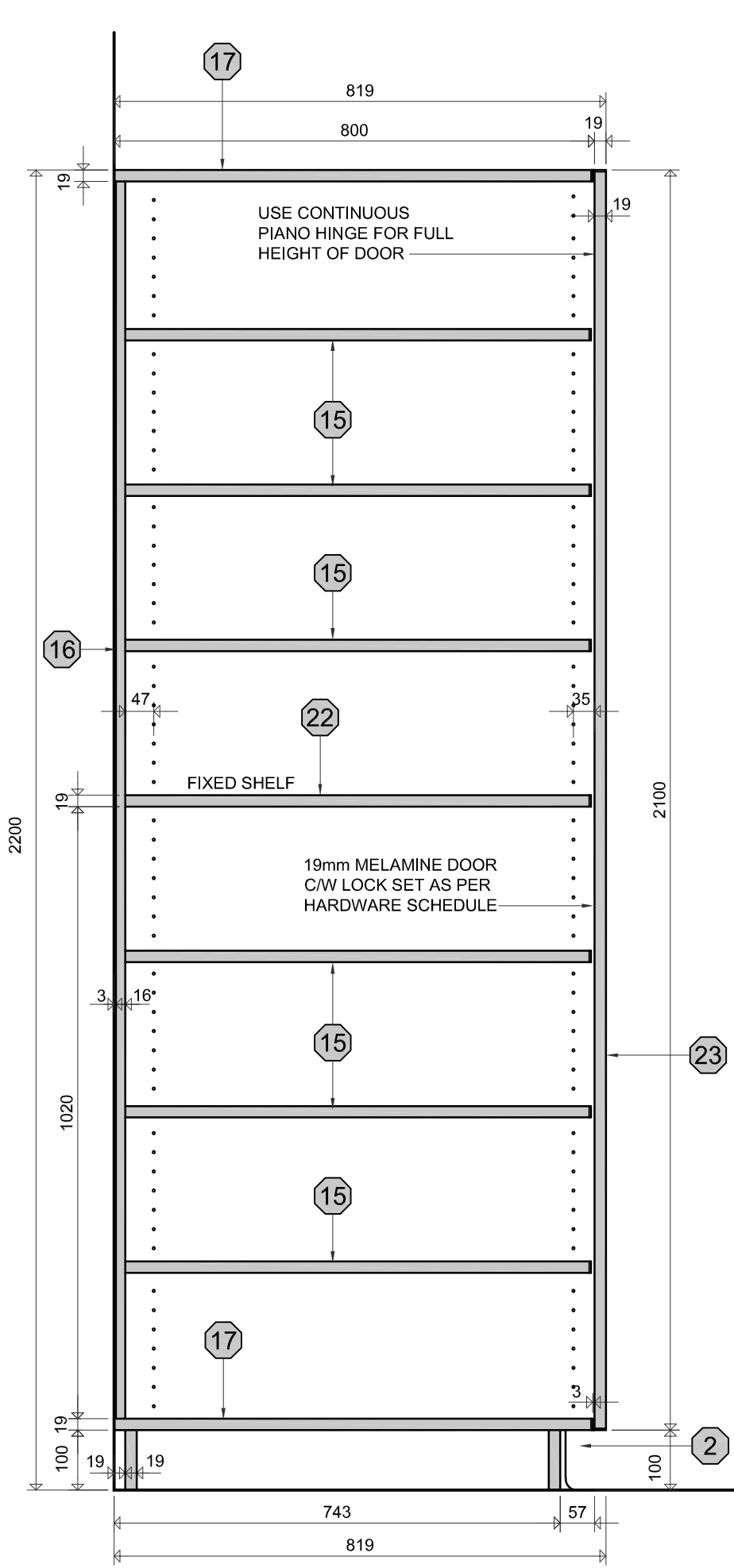

1 SECTION  
AW306

Waterloo-Oxford District Secondary School

Family Studies Renovation & HVAC Upgrades 1206 Snyder's Rd W, New Hamburg, ON N3A 1A4

5 SHELF STORAGE CABINET - SECTION

Project No.:  
1065G

Plot Date:  
2024-02-15

AW306

110-700 Richmond St. London ON Canada N6A 5C7  
P 519 432 6644 F 519 432 6737  
cornerstonearchitecture.ca

© 2024 Cornerstone Architecture Incorporated. All Rights Reserved.

CORNERSTONE  
ARCHITECTURE

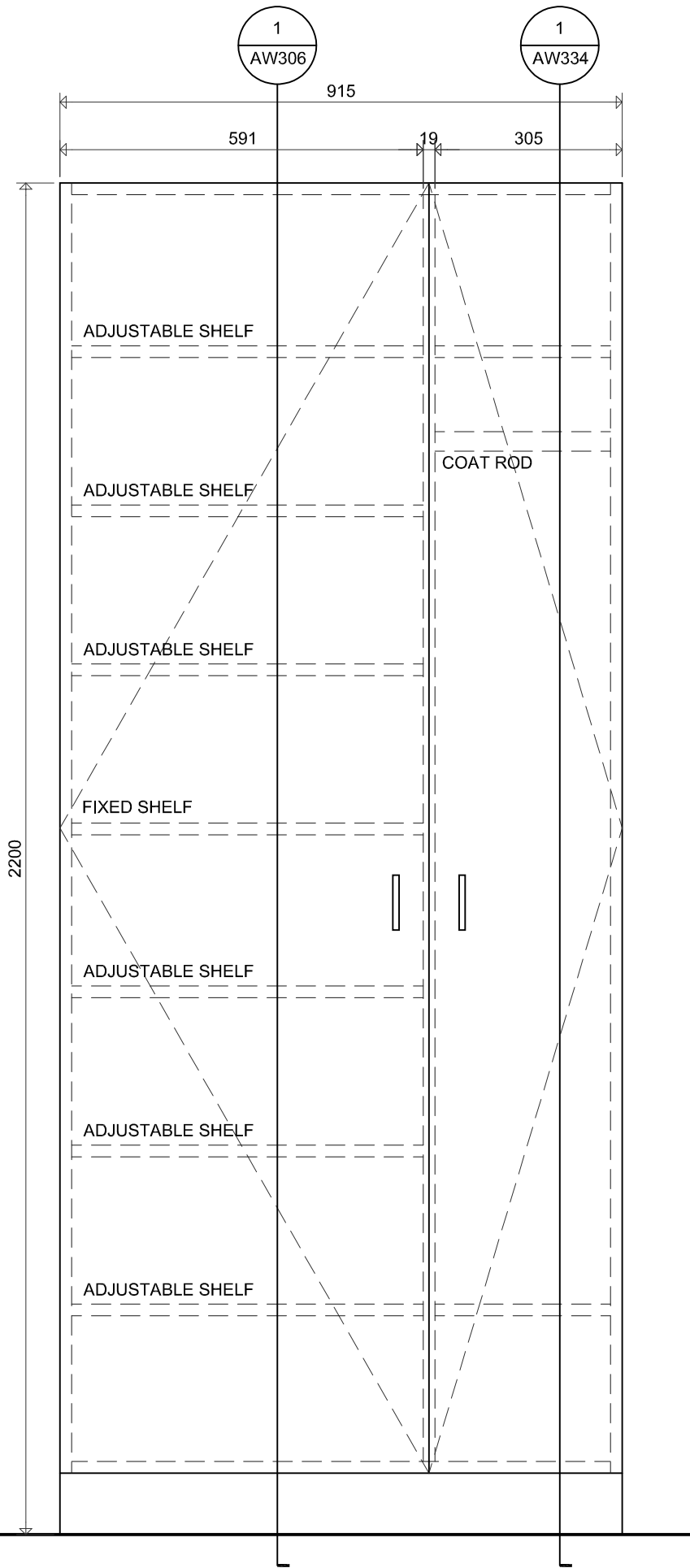

**ELEVATION**

1  
AW333

**Waterloo-Oxford District Secondary School**

Family Studies Renovation & HVAC Upgrades 1206 Snyder's Rd W, New Hamburg, ON N3A 1A4

**TEACHERS CLOSETS - TYPE 4 - 2 DOORS - ELEVATION**

Project No.:  
**1065G**

Plot Date:  
2024-02-15

**AW333**

110-700 Richmond St. London ON Canada N6A 5C7  
P 519 432 6644 F 519 432 6737  
cornerstonearchitecture.ca

**CORNERSTONE**  
ARCHITECTURE



NOTE: REFER TO AW001 AND THE SPECIFICATIONS FOR APPROPRIATE PRODUCTS

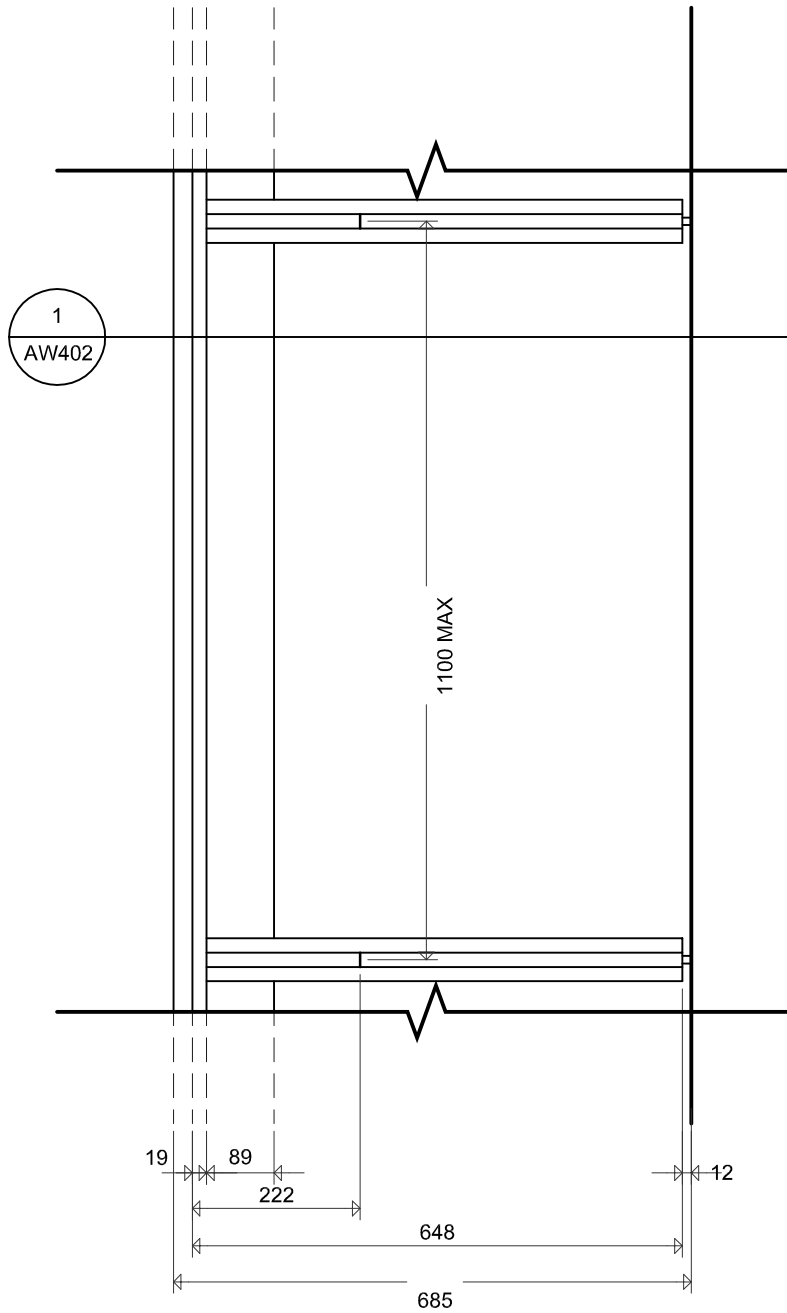

1  
AW401

**ELEVATION**

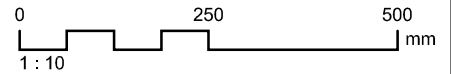

**Waterloo-Oxford District Secondary School**

FAMILY STUDIES RENOVATION & HVAC UPGRADES 1206 Snyder's Rd. W, New Hamburg, ON

Project No.:

1065G

**SEWING WORKSTATION**

Plot Date:

2024-3-26

**CORNERSTONE**  
ARCHITECTURE

110-700 Richmond St. London ON Canada N6A 5C7  
P 519 432 6644 F 519 432 6737

cornerstonearchitecture.ca

© 2024 Cornerstone Architecture Incorporated. All Rights Reserved.

**AW401**

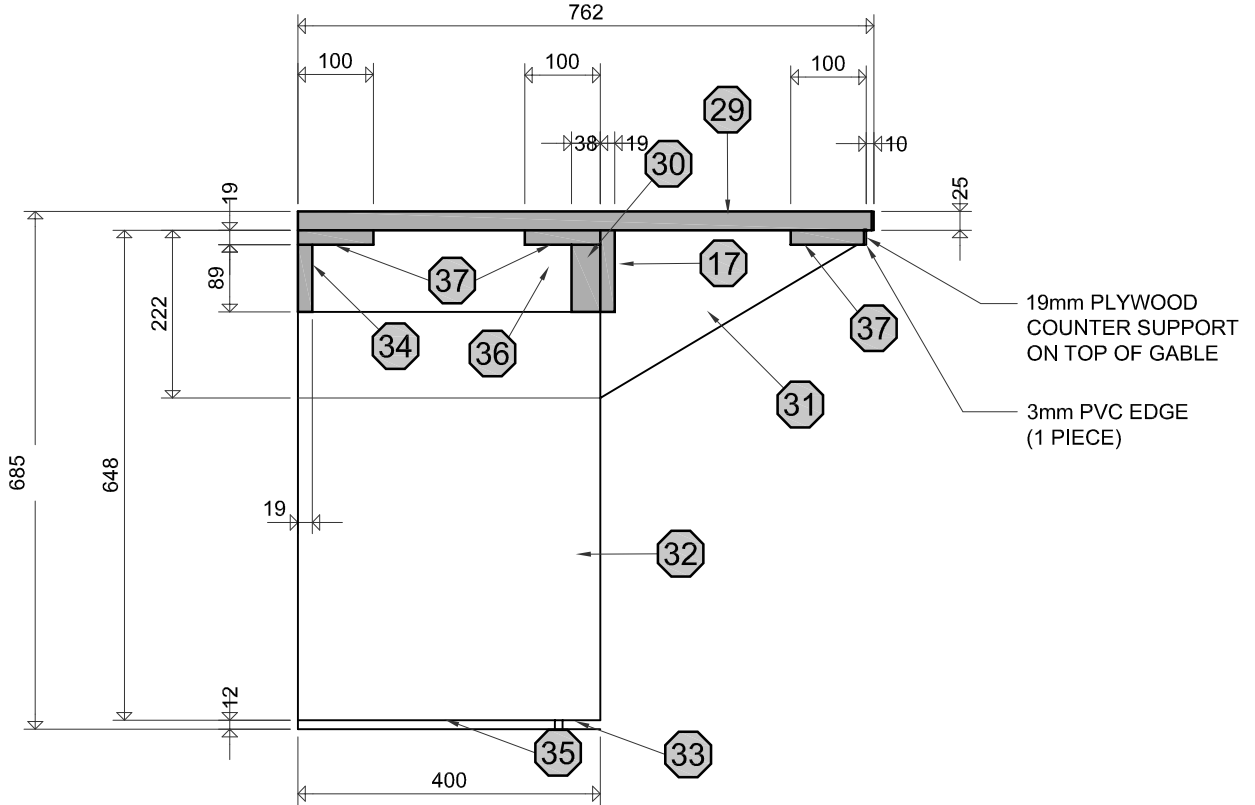

1 SECTION  
AW402

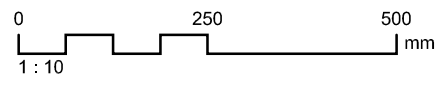

**Waterloo-Oxford District Secondary School**  
FAMILY STUDIES RENOVATION & HVAC UPGRADES 1206 Snyder's Rd. W, New Hamburg, ON

Project No.:  
**1065G**

**SEWING WORK STATION**

Plot Date:  
2024-3-26

**CORNERSTONE**  
ARCHITECTURE

110-700 Richmond St. London ON Canada N6A 5C7  
P 519 432 6644 F 519 432 6737  
cornerstonearchitecture.ca  
© 2024 Cornerstone Architecture Incorporated. All Rights Reserved.

**AW402**



SUPPLY AND INSTALL (1), PER CUTTING TABLE, 1524mm X 3048mm TRANSLUCENT, SELF HEALING, CUTTING MAT c/w GRID UNDERLAY. CUT MAT AND GRID UNDERLAY TO SUIT TABLE TOP. CUTS TO BE UNIFORMLY STRAIGHT AND FREE OF SHARP EDGES.

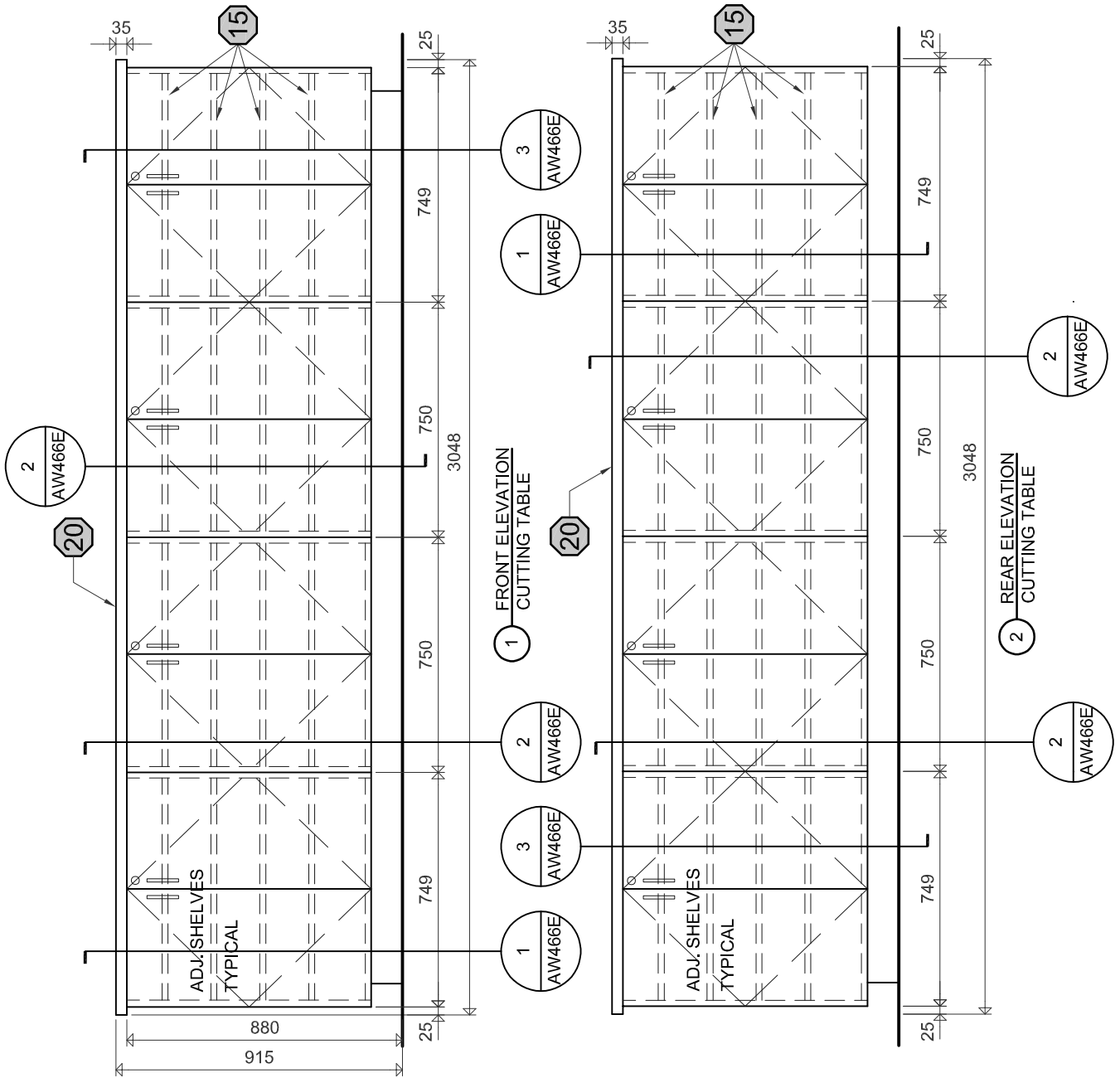

NOTE: REFER TO AW001 AND THE SPECIFICATIONS FOR APPROPRIATE PRODUCTS

1  
AW463B

## SECTION & ELEVATION

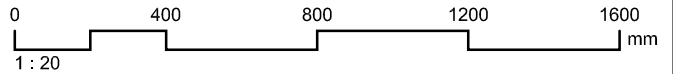

# Waterloo-Oxford District Secondary School

FAMILY STUDIES RENOVATION & HVAC UPGRADES 1206 Snyder's Rd. W, New Hamburg, ON

Project No.:

1065G

## CUTTING TABLE - ELEVATIONS

### PLASTIC LAMINATE COUNTER TOP

Plot Date:

2024-2-23

**CORNERSTONE**  
ARCHITECTURE

110-700 Richmond St. London ON Canada N6A 5C7  
P 519 432 6644 F 519 432 6737

cornerstonearchitecture.ca

**AW463B**

© 2024 Cornerstone Architecture Incorporated. All Rights Reserved.

N:\Projects\1065 WRDSB Small Projects 2022-2023\1065G - Waterloo-Oxford District Secondary School\DRAWINGS\TECHNICAL\1065G-MILL\WORK.dwg, 2024 Feb 23, 02:15 pm

2024-03-22 ISSUED FOR OWNER REVIEW

COUNTER POP-UP RECEPTACLES,  
BY ELECTRICAL TRADE, MODEL  
NO. PUFP-CT-xx, BY LEW  
ELECTRIC FITTINGS COMPANY OR  
APPROVED ALTERNATE

COUNTER POP-UP RECEPTACLES,  
BY ELECTRICAL TRADE, MODEL  
NO. PUFP-CT-xx, BY LEW  
ELECTRIC FITTINGS COMPANY OR  
APPROVED ALTERNATE

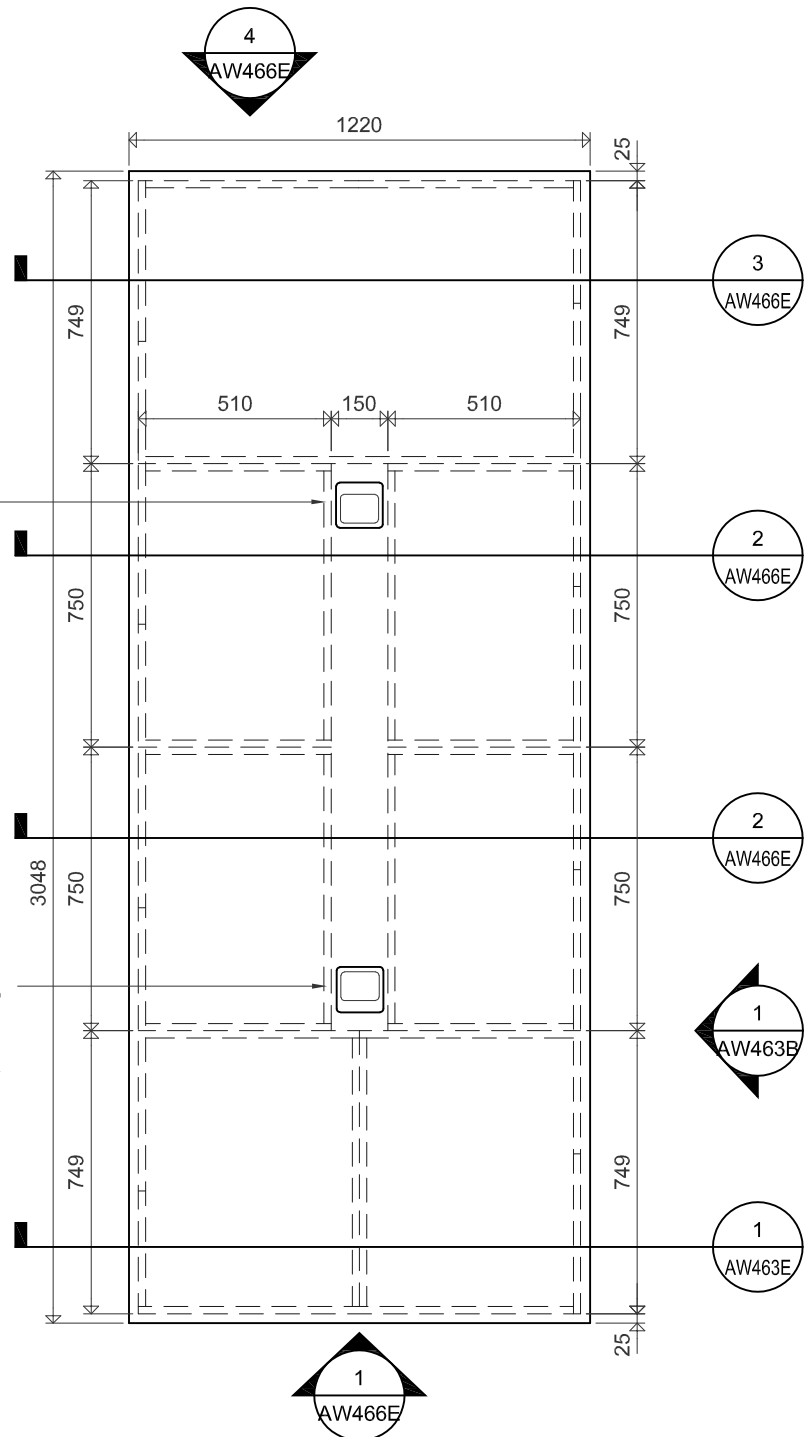

NOTE: COORDINATE ORIENTATION WITH OWNER

NOTE: REFER TO AW001 AND THE SPECIFICATIONS FOR APPROPRIATE PRODUCTS

1  
AW464B

### SECTION & ELEVATION

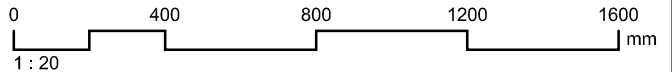

# Waterloo-Oxford District Secondary School

FAMILY STUDIES RENOVATION & HVAC UPGRADES 1206 Snyder's Rd. W, New Hamburg, ON

Project No.:  
1065G

## CUTTING TABLE - PLAN VIEW

### PLASTIC LAMINATE COUNTER TOP

Plot Date:  
2024-2-23

# CORNERSTONE

ARCHITECTURE

110-700 Richmond St. London ON Canada N6A 5C7  
P 519 432 6644 F 519 432 6737

cornerstonearchitecture.ca

© 2024 Cornerstone Architecture Incorporated. All Rights Reserved.

# AW464B

N:\Projects\1065 WRDSB Small Projects 2022-2023\1065G - Waterloo-Oxford District Secondary School\DRAWINGS\TECHNICAL\1065G-MILLWORK.dwg, 2024 Feb 23, 02:15 pm

2024-03-22 ISSUED FOR OWNER REVIEW

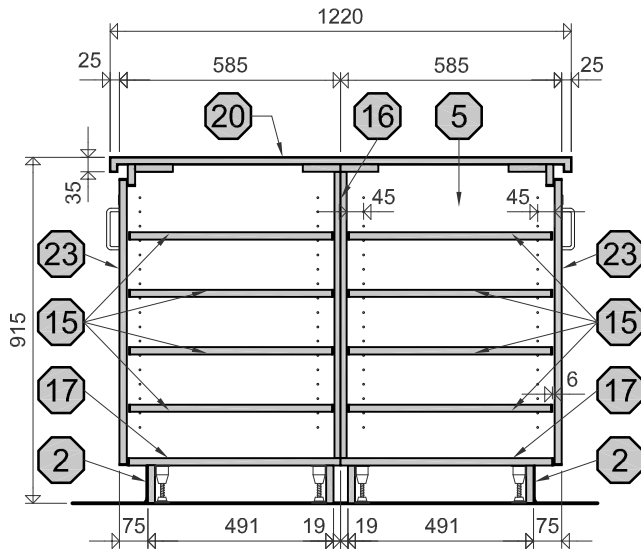

1 TYPICAL MILLWORK SECTION CUTTING TABLE

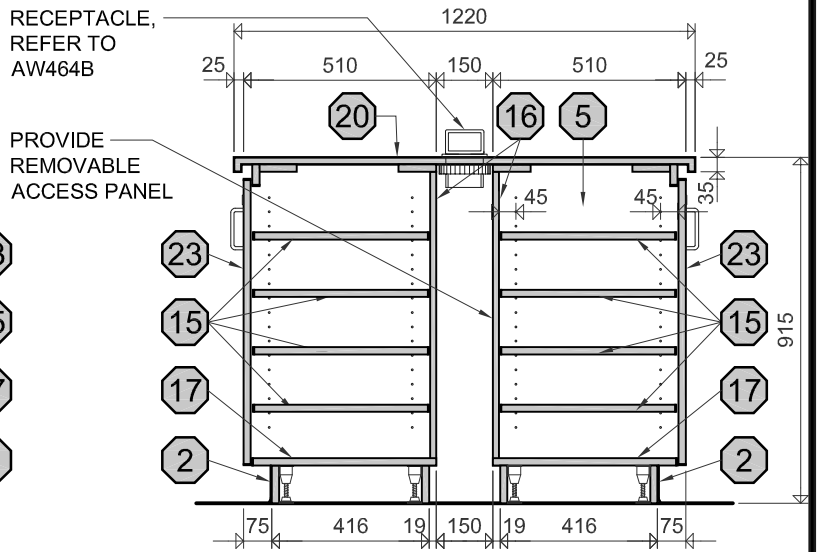

2 TYPICAL MILLWORK SECTION CUTTING TABLE

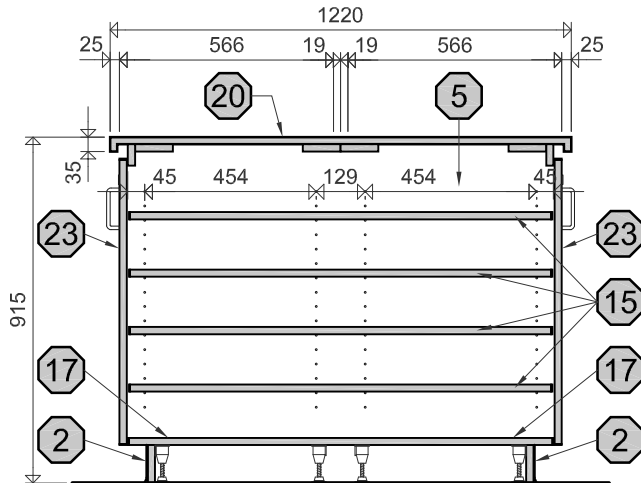

3 TYPICAL MILLWORK SECTION CUTTING TABLE

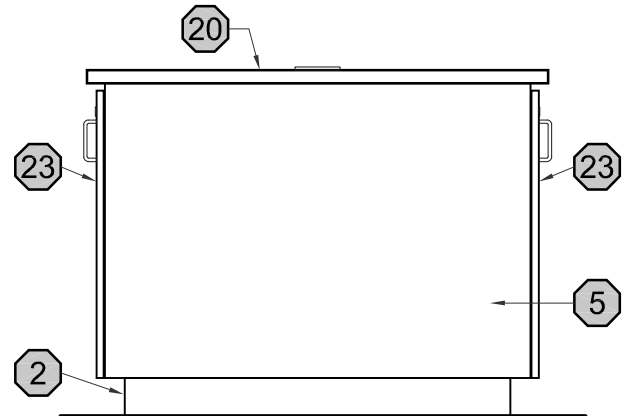

4 TYPICAL MILLWORK ELEVATION CUTTING TABLE

SUPPLY AND INSTALL (1), PER CUTTING TABLE, 1524mm X 3048mm TRANSLUCENT, SELF HEALING, CUTTING MAT c/w GRID UNDERLAY. CUT MAT AND GRID UNDERLAY TO SUIT TABLE TOP. CUTS TO BE UNIFORMLY STRAIGHT AND FREE OF SHARP EDGES.

NOTE: REFER TO AW001 AND THE SPECIFICATIONS FOR APPROPRIATE PRODUCTS

1  
AW466E

## SECTION & ELEVATION

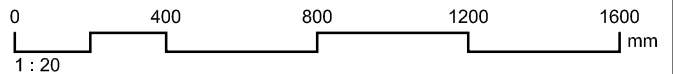

# Waterloo-Oxford District Secondary School

FAMILY STUDIES RENOVATION & HVAC UPGRADES 1206 Snyder's Rd. W, New Hamburg, ON

Project No.:

1065G

## CUTTING TABLE - SECTIONS & ELEVATION

### PLASTIC LAMINATE COUNTER TOP

Plot Date:

2024-2-23

**CORNERSTONE**  
ARCHITECTURE

110-700 Richmond St. London ON Canada N6A 5C7  
P 519 432 6644 F 519 432 6737

cornerstonearchitecture.ca

**AW466E**

© 2024 Cornerstone Architecture Incorporated. All Rights Reserved.

## **PART 1 - GENERAL**

### 1.1 General

- .1 Conform to Division 01 – General Requirements.

### 1.2 Related Sections

- .1 Section 06 10 10 – Rough Carpentry.
- .2 Section 09 22 16 – Non-structural Metal Framing.

### 1.3 References

- .1 American Society for Testing and Materials (ASTM)
  - .1 ASTM C 1320-99, Standard Practice for Installation of Mineral Fibre Batt and Blanket Thermal Insulation for Light Frame Construction.
- .2 Canadian Standards Association (CSA)
  - .1 CSA B111, Wire Nails, Spikes and Staples.

## **PART 2 - PRODUCTS**

### 2.1 Insulation

- .1 Batt and blanket mineral fibre: to CAN/ULC S702-14, Type 1, thickness as indicated on Drawings.
- .2 Sound attenuation blanket, friction fit; thicknesses as indicated on Drawings.
  - .1 “Thermafibre” by CGC Inc.
  - .2 “SAB” by Fibrex Insulations Inc.
  - .3 “Quietzone” by Owens Corning
  - .4 “Sound Attenuation” by Roxul.

### 2.2 Accessories

- .1 Insulation clips:
  - .1 Impale type, perforated 50mm x 50mm cold rolled carbon steel 0.8mm thick, adhesive back, spindle of 2.5mm diameter annealed steel, length to suit insulation, 25mm diameter washers of self locking type.
- .2 Nails: galvanized steel, length to suit insulation plus 25mm, to CSA B111.
- .3 Staples: 12mm minimum leg.
- .4 Tape: as recommended by manufacturer.

## **PART 3 - EXECUTION**

### 3.1 General

- .1 Install materials in accordance with manufacturer’s installation instructions.

### 3.2 Examination

- .1 Examine substrates and immediately inform Consultant in writing of defects.

- .2 Take measurements of the Place of Work to ensure that work is fabricated to fit structure; surrounding construction; around obstructions and projections in place, or as indicated; and to suit locations of services.
- 3 Verify that backup construction is aligned for proper installation of Work before commencing erection.

### 3.3 Insulation Installation

- .1 Install insulation to maintain continuity of thermal protection to building elements and spaces.
- .2 Install insulation with vapour barrier facing warm side of building spaces. Lap ends and side flanges of membrane over framing members. Retain in position with staples, installed as recommended by manufacturer. Tape seal butt ends and lapped side flanges. Do not tear or cut vapour barrier.
- .3 Install sound attenuation batts where indicated on Drawings, **full height of wall**.
- .4 Fit insulation closely around electrical boxes, pipes, ducts, frames and other objects in or passing through insulation.
- .5 Do not compress insulation to fit into spaces.
- .6 Keep insulation minimum 75mm from heat emitting devices such as recessed light fixtures, and minimum 50mm from sidewalls of CAN/ULC-S604 Type A chimneys and CAN/CGA-B149.1 and CAN/CGA-B149.2 Type B and L vents.
- .7 Do not enclose insulation until it has been inspected and approved by Consultant.

END OF SECTION

**PART 1 - GENERAL**

1.1 General

- .1 Conform to Division 01 – General Requirements.

1.2 References

- .1 Underwriters Laboratories of Canada (ULC)
  - .1 CAN/ULC-S101-14.
  - .2 CAN/ULC-S102-10.

1.3 Test Reports

- .1 Submit product data including certified copies of test reports verifying fireproofing applied to substrate as constructed on project will meet or exceed requirements of Specification.
- .2 Submit test results in accordance with CAN/ULC-S101 for fire endurance and CAN/ULC-S102 for surface burning characteristics.
- .3 For assemblies not tested and rated, submit proposals based on related designs using accepted fireproofing design criteria.

1.4 Samples

- .1 Submit samples in accordance with Section 01 33 00 – Submittal Procedures.
- .2 Submit applicable U.L.C. Design Numbers for all conditions required on this project, including applicable acceptance information from U.L.C. for the materials specified. Proof of total compliance rests with the fireproofing applicator.

1.5 Mock Up

- .1 Apply fireproofing to approximately 10m<sup>2</sup> area of surface to be treated.
- .2 Allow 24 hours for inspection of mock-up by Consultant before proceeding with fireproofing work.

1.6 Protection

- .1 At outdoor temperatures less than 5°C, ensure that a 5°C air and substrate temperature is maintained during and for 24 hours after application. Ensure that natural ventilation to properly dry the fireproofing during and subsequent to its application is provided. In enclosed areas lacking openings for natural ventilation, ensure that interior air is circulated and exhausted to the outside.
- .2 Provide temporary enclosures to prevent spray from contaminating air beyond application area.
- .3 Protect adjacent surfaces and equipment from damage by overspray, fall-out, and dusting of fireproofing materials.

---

## **PART 2 - PRODUCTS**

### 2.1 Sprayed Fireproofing:

- .1 Sprayed fireproofing: non-combustible, spray-applied, portland cement-based fire resistive material, factory-mixed powder, mixed with water prior to application, providing fire resistance ratings indicated on Drawings.
  - .1 Acceptable Materials: "A/D Fire Protection Systems Southwest Fireproofing Type 5" by A/D Fire Protection Systems, "Caftco 300" by Isolatek International, Monokote MK-6 by GCP Applied Technologies.
- .2 Auxiliary Materials:
  - .1 Primer/ Adhesive: Manufacturer's standard adhesive designed for use with specified fireproofing.
  - .2 Water: clean, potable.

## **PART 3 - EXECUTION**

### 3.1 Preparation

- .1 Substrate shall be free of material, which would impair bond.
- .2 Verify that painted substrates are compatible and have suitable bonding characteristics to receive fireproofing.
- .3 Remove incompatible materials.
- .4 Ensure that items required to penetrate fireproofing are placed before installation of fireproofing.
- .5 Ensure that ducts, piping, equipment, or other items which would interfere with application of fireproofing are not positioned until fireproofing work is completed.

### 3.2 Application

- .1 Apply bonding adhesive or primer to substrate if recommended by manufacturer.
- .2 Apply fireproofing to correspond with tested assemblies, or acceptable calculation procedures to provide following fire resistance ratings.
- .3 Apply fireproofing over substrate, building up to required thickness to cover substrate with monolithic blanket of uniform density and texture.
- .4 Apply fireproofing directly to structural steel without use of expanded lath.
- .5 Tamp smooth, surfaces as indicated.
- .6 Apply curing compound **with blue tint** to surface of cementitious fireproofing as required by manufacturer in areas where sprayed fireproofing will not have a finish paint coat (i.e. above acoustic tile ceilings).
- .7 Apply sealer to surface of mineral fibre fireproofing as required by manufacturer in ventilation plenums, where fireproofing is to be painted and as indicated.

### 3.3 Patching

- .1 Patch damage to fireproofing caused by testing or by other trades, including attachment of partition framing, before fireproofing is concealed, or if exposed, before final inspection.

END OF SECTION

## **PART 1 - GENERAL**

### 1.1 General

- .1 Conform to Division 01 – General Requirements.

### 1.2 Related Work

- .1 Fire stopping and smoke seals within mechanical assemblies (i.e. inside ducts, dampers) and electrical assemblies (i.e. inside cable trays) are specified in Division 20 through 28 respectively.

### 1.3 References

- .1 Underwriter's Laboratories of Canada (ULC)
  - .1 ULC-S115-05, Fire Test of Firestop Systems.

### 1.4 Samples

- .1 Submit samples in accordance with Section 01 33 00 - Submittal Procedures.
- .2 Submit duplicate 300mm x 300mm samples showing actual firestop material proposed for project.

### 1.5 Shop Drawings

- .1 Submit shop drawings in accordance with Section 01 33 00 - Submittal Procedures.
- .2 Submit shop drawings to show proposed material, reinforcement, anchorage, fastenings and method of installation. Construction details should accurately reflect actual job conditions.

### 1.6 Product Data

- .1 Submit product data in accordance with Section 01 33 00 - Submittal Procedures.
- .2 Submit manufacturer's product data for materials and prefabricated devices, providing descriptions are sufficient for identification at job site. Include manufacturer's printed instructions for installation.

## **PART 2 - PRODUCTS**

### 2.1 Materials

- .1 Fire stopping and smoke seal systems: in accordance with ULC-S115.
  - .1 Asbestos-free materials and systems capable of maintaining an effective barrier against flame, smoke and gases in compliance with requirements of ULC-S115 and not to exceed opening sizes for which they are intended.
  - .2 Firestop system rating: as indicated on Drawings for each condition.
- .2 Service penetration assemblies: certified by ULC in accordance with ULC-S115 and listed in ULC Guide No.40 U19.
- .3 Service penetration firestop components: certified by ULC in accordance with ULC-S115 and listed in ULC Guide No.40 U19.13 and ULC Guide No.40 U19.15 under the Label Service of ULC.
- .4 Fire-resistance rating of installed fire stopping assembly in accordance with NBC.



- .5 Fire stopping and smoke seals at openings intended for ease of re-entry such as cables: elastomeric seal.
- .6 Fire stopping and smoke seals at openings around penetrations for pipes, ductwork and other mechanical items requiring sound and vibration control: elastomeric seal.
- .7 Primers: to manufacturer's recommendation for specific material, substrate, and end use.
- .8 Water (if applicable): potable, clean and free from injurious amounts of deleterious substances.
- .9 Damming and backup materials, supports and anchoring devices: to manufacturer's recommendations, and in accordance with tested assembly being installed as acceptable to authorities having jurisdiction.
- .10 Sealants for vertical joints: non-sagging.

### **PART 3 - EXECUTION**

#### 3.1 Preparation

- .1 Examine sizes and conditions of voids to be filled to establish correct thicknesses and installation of materials. Ensure that substrates and surfaces are clean, dry and frost free.
- .2 Prepare surfaces in contact with fire stopping materials and smoke seals to manufacturer's instructions.
- .3 Maintain insulation around pipes and ducts penetrating fire separation.
- .4 Mask where necessary to avoid spillage and over coating onto adjoining surfaces; remove stains on adjacent surfaces.

#### 3.2 Installation

- .1 Install fire stopping and smoke seal material and components in accordance with ULC certification and manufacturer's instructions.
- .2 Seal holes or voids made by through penetrations, poke-through termination devices, and unpenetrated openings or joints to ensure continuity and integrity of fire separation are maintained.
- .3 Provide temporary forming as required and remove forming only after materials have gained sufficient strength and after initial curing.
- .4 Tool or trowel exposed surfaces to a neat finish.
- .5 Remove excess compound promptly as work progresses and upon completion.

#### 3.3 Inspection

- .1 Notify Consultant when ready for inspection and prior to concealing or enclosing firestopping materials and service penetration assemblies.

#### 3.4 Schedule

- .1 Firestop and smoke seal at:
  - .1 Penetrations through fire-resistance rated masonry, concrete, and gypsum board partitions and walls.
  - .2 Top of fire-resistance rated masonry and gypsum board partitions.
  - .3 Intersection of fire-resistance rated masonry and gypsum board partitions.
  - .4 Control and sway joints in fire-resistance rated masonry and gypsum board partitions and walls.
  - .5 Penetrations through fire-resistance rated floor slabs, ceilings and roofs.
  - .6 Openings and sleeves installed for future use through fire separations.
  - .7 Around mechanical and electrical assemblies penetrating fire separations.

- .8 Rigid ducts: greater than 129 cm<sup>2</sup>: fire stopping to consist of bead of fire stopping material between retaining angle and fire separation and between retaining angle and duct, on each side of fire separation.

3.5 Clean Up

- .1 Remove excess materials and debris and clean adjacent surfaces immediately after application.
- .2 Remove temporary dams after initial set of firestopping and smoke seal materials.

END OF SECTION

## **PART 1 - GENERAL**

### 1.1 General

- .1 Conform to Division 01 - General Requirements.

### 1.2 References

- .1 CAN/CGSB-19.1-M87, Putty, Linseed Oil Type.
- .2 CAN/CGSB-19.2-M87, Glazing Compound, Nonhardening, Modified Oil Type.
- .3 CGSB 19-GP-5M-76, Sealing Compound, One Component, Acrylic Base, Solvent Curing.
- .4 CAN/CGSB-19.6-M87, Caulking Compound, Oil Base.
- .5 CAN/CGSB-19.13-M87, Sealing Compound, One-component, Elastomeric, Chemical Curing.
- .6 CGSB 19-GP-14M-76, Sealing Compound, One Component, Butyl-polyisobutylene Polymer Base, Solvent Curing.
- .7 CAN/CGSB-19.17-M90, One-Component Acrylic Emulsion Base Sealing Compound.
- .8 CAN/CGSB-19.18-M87, Sealing Compound, One Component, Silicone Base, Solvent Curing.
- .9 CAN/CGSB-19.20-M87, Cold-applied Sealing Compound, Aviation Fuel-resistant.
- .10 CAN/CGSB-19.21-M87, Sealing and Bedding Compound Acoustical.
- .11 CAN/CGSB-19.22-M89, Mildew Resistant, Sealing Compound for Tubs and Tiles.
- .12 CAN/CGSB-19.24-M90, Multi-component, Chemical Curing Sealing Compound.

### 1.3 Samples

- .1 Submit samples in accordance with General Requirements.
- .2 Submit duplicate samples of each type of material and colour.

### 1.4 Mock-up

- .1 Construct mock-up in accordance with General Requirements.
- .2 Construct mock-up to show location, size, shape and depth of joint s complete with back-up material, primer, caulking and sealant. Mock-up may be part of finished work.
- .3 Allow 24 hours for inspection of mock-up by Consultant before proceeding with sealant work.

### 1.5 Delivery, Storage and Handling

- .1 Deliver, handle, store and protect materials in accordance with General Requirements.
- .2 Deliver and store materials in original wrappings and containers with manufacturer's seals and labels, intact. Protect from freezing, moisture, water and contact with ground or floor.

### 1.6 Environmental and Safety Requirements

- .1 Comply with requirements of Workplace Hazardous Materials Information System (WHMIS) regarding use, handling, storage, and disposal of hazardous materials; and regarding labelling and provision of material safety data sheets acceptable to Labour Canada.
- .2 Conform to manufacturer's recommended temperatures, relative humidity, and substrate moisture content for application and curing of sealants including special conditions governing use.

---

## **PART 2 - PRODUCTS**

### 2.1 Sealant Materials

- .1 Sealants and caulking compounds must:
  - .1 meet or exceed all applicable governmental and industrial safety and performance standards; and
  - .2 be manufactured and transported in such a manner that all steps of the process, including the disposal of waste products arising there from, will meet the requirements of all applicable governmental acts, by laws and regulations including, for facilities located in Canada, the fisheries Act and the Canadian Environmental Protection Act (CEPA).
- .2 Sealant and caulking compounds must not be formulated or manufactured with: aromatic solvents, fibrous talc or asbestos, formaldehyde, halogenated solvents, mercury, lead, cadmium, hexavalent chromium, barium or their compounds, except barium sulfate.
- .3 Sealant and caulking compounds must not contain a total of volatile organic compounds (VOCs) in excess of 5% by weight as calculated from records of the amounts of constituents used to make the product.
- .4 Sealant and caulking compounds must be accompanied by detailed instructions for proper application so as to minimize health concerns and maximize performance, and information describing proper disposal methods.
- .5 Caulking that emits strong odours, contains toxic chemicals or is not certified as mould resistant shall not be used in air handling units.
- .6 When low toxicity caulks are not possible, confine usage to areas which off gas to the exterior, are contained behind air barriers, or are applied several months before occupancy to maximize off-gas time.
- .7 The manufacturing process must adhere to Lifecycle Assessment Standards as per ISO 14040/14041 LCA Standards (to be published by 1998), CSA Z760-94 LCA Standards.
- .8 Sealants acceptable for use on this project must be listed on CGSB Qualified Products List issued by CGSB Qualification Board for Joint Sealants. Where sealants are qualified with primers use only these primers.

### 2.2 Sealant Material Designations

- .1 Urethanes One Part.
  - .1 Non-Sag to CAN/CGSB-19.13, Type 2, colour as selected by Consultant.
- .2 Silicones One Part.
  - .1 To CAN/CGSB-19.22 (Mildew resistant).
- .3 Acrylic Latex One Part.
  - .1 To CAN/CGSB-19.17.
- .4 Acoustical Sealant.
  - .1 To CAN/CGSB-19.21.
- .5 Preformed Compressible and Non-Compressible back-up materials.
  - .1 Polyethylene, Urethane, Neoprene or Vinyl Foam.
    - .1 Extruded closed cell foam backer rod.
    - .2 Size: oversize 30 to 50 %.
  - .2 Bond Breaker Tape.
    - .1 Polyethylene bond breaker tape which will not bond to sealant.

### 2.3 Sealant Selection

- .1 Exterior: Urethane.
- .2 Interior control and expansion joints: Silicone.
- .3 Perimeters of interior frames and millwork: Acrylic Latex.

- .4 Perimeter of bath fixtures (e.g. sinks, tubs, urinals, stools, waterclosets, basins, vanities):  
Sealant type: Mildew Resistant Silicone.
- .5 Exposed interior control joints in drywall: Acrylic Latex.
- .6 Perimeter of walls to ensure continuity of sound proofing: Acoustical.

#### 2.4 Joint Cleaner

- .1 Non-corrosive and non-staining type, compatible with joint forming materials and sealant recommended by sealant manufacturer.
- .2 Primer: as recommended by manufacturer.

### **PART 3 - EXECUTION**

#### 3.1 Protection

- .1 Protect installed work of other trades from staining or contamination.

#### 3.2 Preparation of Joint Surfaces

- .1 Examine joint sizes and conditions to establish correct depth to width relationship for installation of backup materials and sealants; depth ratio  $\frac{1}{2}$  of joint width with minimum width and depth of 6mm, maximum width 12mm
- .2 Clean bonding joint surfaces of harmful matter substances including dust, rust, oil grease, and other matter which may impair work.
- .3 Do not apply sealants to joint surfaces treated with sealer, curing compound, water repellent, or other coatings unless tests have been performed to ensure compatibility of materials. Remove coatings as required.
- .4 Ensure joint surfaces are dry and frost free.
- .5 Prepare surfaces in accordance with manufacturer's directions.

#### 3.3 Priming

- .1 Where necessary to prevent staining, mask adjacent surfaces prior to priming and caulking.
- .2 Prime sides of joints in accordance with sealant manufacturer's instructions immediately prior to caulking.

#### 3.4 Backup Material

- .1 Apply bond breaker tape where required to manufacturer's instructions.
- .2 Install joint filler to achieve correct joint depth and shape, with approximately 30 % compression.

#### 3.5 Mixing

- .1 Mix materials in strict accordance with sealant manufacturer's instructions.

#### 3.6 Application

- .1 Sealant.
  - .1 Apply sealant in accordance with manufacturer's written instructions.
  - .2 Mask edges of joint where irregular surface or sensitive joint border exists to provide neat joint.

- .3 Apply sealant in continuous beads.
- .4 Apply sealant using gun with proper size nozzle.
- .5 Use sufficient pressure to fill voids and joints solid.
- .6 Form surface of sealant with full bead, smooth, free from ridges, wrinkles, sags, air pockets, embedded impurities.
- .7 Tool exposed surfaces before skinning begins to give slightly concave shape.
- .8 Remove excess compound promptly as work progresses and upon completion.
- .2 Curing.
  - .1 Cure sealants in accordance with sealant manufacturer's instructions.
  - .2 Do not cover up sealants until proper curing has taken place.
  - .3 Cleanup.
    - .1 Clean adjacent surfaces immediately and leave work neat and clean.
    - .2 Remove excess and droppings, using recommended cleaners as work progresses.
    - .3 Remove masking tape after initial set of sealant.

END OF SECTION

---

**PART 1 - GENERAL**

1.1 General

- .1 Conform to Division 01 - General Requirements.

1.2 Related Sections

- .1 Section 07 92 10 – Joint Sealing.
- .2 Section 08 50 50 – Aluminum Windows.
- .3 Section 08 80 50 – Glazing.

1.3 References

- .1 Aluminum Association Designation System for Aluminum Finishes (AA)-1997
  - .1 DAF 45, Designation System for Aluminum Finishes.
- .2 Architectural Aluminum Manufacturers Association (AAMA)
  - .1 AAMA CW-DG-1-96, Aluminum Curtain Wall Design Guide Manual.
  - .2 AAMA CW-10-97, Curtain Wall Manual #10 Care and Handling of Architectural Aluminum from Shop to Site.
  - .3 AAMA CW-11-85, Curtain Wall Manual - Design Windloads for Buildings and Boundary Layer Wind Tunnel Testing.
  - .4 AAMA T1R-A1-75, Sound Control for Aluminum Curtain Walls and Windows.
  - .5 AAMA 607.1-76, Specifications and Inspection Methods for Clear Anodic Finishes for Architectural Aluminum.
- .3 American Society for Testing and Materials (ASTM)
  - .1 ASTM A36/ A36M - 14, Specification for Structural Steel.
  - .2 ASTM A123/ A123M - 17, Specification for Zinc (Hot-Dip Galvanized) Coatings on Iron and Steel Products.
  - .3 ASTM A167 – 99 (R2009), Specification for Stainless and Heat-Resisting Chromium-Nickel Steel Plate, Sheet, and Strip.
  - .4 ASTM B209 - 14, Specification for Aluminum and Aluminum-Alloy Sheet and Plate Metric.
  - .5 ASTM B221 - 14, Specification for Aluminum-Alloy Extruded Bars, Rods, Wire, Profiles, and Tubes.
  - .6 ASTM E283 – 04(2012), Test Method for Determining the Rate of Air Leakage Through Exterior Windows, Curtain Walls, and Doors Under Specified Pressure Differences Across the Specimen.
  - .7 ASTM E330/ E330M - 14, Test Method for Structural Performance of Exterior Windows, Curtain Walls, and Doors by Uniform Static Air Pressure Difference.
  - .8 ASTM E331 - 00(2016), Test Method for Water Penetration of Exterior Windows, Curtain Walls, and Doors by Uniform Static Air Pressure Difference.
  - .9 ASTM E413 - 16, Classification for Rating Sound Insulation.
- .4 Canadian General Standards Board (CGSB)
  - .1 CAN/CGSB 1.108-M89, Bituminous Solvent Type Paint.
- .5 Canadian Standards Association (CSA)
  - .1 CSA G40.20/G40.21-13 (R2018), General Requirements for Rolled or Welded Structural Quality Steel/Structural Quality Steels.
  - .2 CAN/CSA-G164-M92 (R2003), Hot Dip Galvanizing of Irregularly Shaped Articles.
  - .3 CAN/CSA-S136-01 (R2007), Cold Formed Steel Structural Members.
  - .4 CAN/CSA-S157-05 (R2015), Strength Design in Aluminum.
  - .5 CSA W59.2-M1991(R2008), Welded Aluminum Construction.

#### 1.4 System Description

- .1 Vertical glazed aluminum curtain wall system includes thermally broken tubular aluminum sections with self supporting framing, shop fabricated, factory prefinished, vision glass, glass spandrel infill, column covers, related flashings, anchorage and attachment devices.
- .2 Assembled system to permit re-glazing of individual glass units without requiring removal of structural mullion sections.

#### 1.5 Performance Requirements

- .1 Design and size components to withstand dead and live loads caused by pressure and suction of wind, acting normal to plane of system as calculated in accordance with NBC to a design pressure of 1.44 kPa. as measured in accordance with ASTM E330. Provide all structural reinforcement as required by design.
- .2 Design and size components to withstand seismic loads and sway displacement as calculated in accordance with NBC.
- .3 Limit mullion deflection to  $L/175$ ; with full recovery of glazing materials.
- .4 Size glass units and glass dimensions to limits established in CAN/CGSB-12.20.
- .5 Provide system to accommodate, without damage to components or deterioration of seals:
  - .1 Movement within system.
  - .2 Movement between system and perimeter framing components.
  - .3 Dynamic loading and release of loads.
  - .4 Deflection of structural support framing.
- .6 Limit air infiltration through assembly to  $0.0003 \text{ m}^3/\text{s}/\text{m}^2$  of wall area, measured at a reference differential pressure across assembly of 3 Pa as measured in accordance with ASTM E283.
- .7 Vapour seal with interior atmospheric pressure of 25mm sp, 22°C, 40% RH: No failure.
- .8 Water leakage: none, when measured in accordance with ASTM E331.
- .9 Drain water entering joints, condensation occurring in glazing channels, or migrating moisture occurring within system, to the exterior by a weep drainage network.
- .10 Maintain continuous air barrier and vapour retarder throughout assembly, primarily in line with inside pane of glass and heel bead of glazing compound. Position thermal insulation on exterior surface of air barrier and vapour retarder.
- .11 Ensure no vibration harmonics, wind whistles, noises caused by thermal movement, thermal movement transmitted to other building elements, loosening, weakening, or fracturing of attachments or components of system occur.

#### 1.6 Approved Manufacturers

- .1 The Drawings are based upon Alumicor Series 2600 capped curtain wall system. Refer to Drawings for locations of curtain wall types.
- .2 Approved manufacturers are approved, subject to total compliance with this Specification:
  - .1 Kawneer Company of Canada Limited.
  - .2 Sherwood Windows Group.
  - .3 Aerloc Industries Ltd.

#### 1.7 Product Data

- .1 Submit product data in accordance with Section 01 33 00 - Submittal Procedures.
- .2 Prior to shop drawing submittals provide the following:
  - .1 Thermal Simulation: to demonstrate conformance with SB-10. Submit a project specific thermal simulation in general accordance with CSA A440.2, NFRC100-200, NFRC200-2001 and NFRC500-2010.
  - .2 Thermal simulation to be based on the most frequent façade modules.



- 
- .3 Thermal simulation must be completed by or signed as reviewed by a NFRC Certified Simulator listed on [www.nfrccommunity.org/page/CertifiedSimulators](http://www.nfrccommunity.org/page/CertifiedSimulators)
  - .4 Generic thermal simulation charts that are not based on the specified glass will Not be accepted.
  - .3 Provide component dimensions, describe components within assembly, anchorage and fasteners, glass and infill, internal drainage details and water flow diagrams.
- 1.8 Shop Drawings
- .1 Submit shop drawings in accordance with Section 01 33 00 - Submittal Procedures.
  - .2 Indicate system dimensions, framed opening requirements and tolerances, adjacent construction, anticipated deflection under load, affected related Work, weep drainage network, expansion and contraction joint location and details, and field welding required.
  - .3 **Shop drawings shall bear the stamp of a Registered Professional Engineer licensed to practice in Ontario.**
- 1.9 Design Data
- .1 Submit design data in accordance with Section 01 33 00 - Submittal Procedures.
- 1.10 Pre-installation Meeting
- .1 Convene one week before starting work of this Section.
- 1.11 Delivery, Storage, and Handling
- .1 Deliver, store, handle and protect materials in accordance with Section 01 61 00 -. Basic Product Requirements.
  - .2 Handle work of this section in accordance with AAMA CW-10.
  - .3 Protect prefinished aluminum surfaces with wrapping. Do not use adhesive papers or sprayed coatings which bond when exposed to sunlight or weather.
- 1.12 Environmental Requirements
- .1 Do not install sealants when ambient and surface temperature is less than 5°C.
  - .2 Maintain this minimum temperature during and after installation of sealants.
- 1.13 Sequencing
- .1 Coordinate work of this section with installation of air barrier placement, vapour retarder placement, flashing placement.
- 1.14 Warranty
- .1 Provide a written warranty, signed and issued in the name of the Owner and the Project, stating that the Contractor, Sub-Contractor and/or manufacturer jointly and severally warrant the complete aluminum frame system against leakage, in accordance with GC 12.3 as amended by the Supplementary General Conditions, but for a period of five (5) years.

---

## **PART 2 - PRODUCTS**

### 2.1 Materials

- .1 Extruded aluminum: AA6063-T6 alloy.
- .2 Sheet aluminum: AA alloy 5005-HSX.
- .3 Fasteners: stainless steel.
- .4 Bituminous paint: CAN/CGSB 1.108, Type 1, without thinner.
- .5 Vertical Glass Units:
  - .1 Glass in exterior lights: Insulated tempered glass units.
  - .2 Glass in entrance lights: Insulated tempered glass units.
  - .3 Refer to Section 08 80 50.
- .6 Sealant: to Section 07 92 10.

### 2.2 Components

- .1 Mullion profiles: thermally broken with interior tubular section insulated from exterior pressure plate; matching stops and pressure plate of sufficient size and strength to provide adequate bite on glass and infill panels; drainage holes, deflector plates and internal flashings to accommodate internal weep drainage system; internal mullion baffles to eliminate "stack effect" air movement within internal spaces. Refer to Drawings for profile sizes, shapes and locations.
- .2 Mullion caps: provide standard mullion caps as indicated on Drawings and as indicated below.
  - .1 Standard mullion cap: 19.1mm standard cap.
- .3 Infill panel: internally reinforced, glazing edge sealed permitting internal air movement to glazing space, outside air barrier line:
  - .1 Outer face: insulated spandrel glass unit; refer to Section 08 80 50.
  - .2 Core: rigid polystyrene insulation core with maximum RSI to maintain 6mm maximum gap between glass unit and insulation.
  - .3 Inner liner panels: 3.18mm thick galvanized steel.
- .4 Fabricate spandrel panels for 'glazed in' installation.
- .5 Column covers: 3.18mm thick aluminum, full contact pressure bonded to, ensuring flat surface, finish to match curtain wall mullion sections, secured with concealed fastening method.
- .6 Flashings: 3.18mm thick architectural aluminum, finish to match curtain wall mullion sections where exposed, brake-formed to shapes indicated; secured with concealed fastening method.
- .7 Thermal Break: extruded rigid PVC.
- .8 Gaskets: extruded EPDM.
- .9 Sealant backing rod: Extruded foam closed cell, round polyethylene rod, 25% wider than joint width, "H.B.R." backer rod, or non-gassing "SOF Rod" by Tremco.
- .10 Vapour retarder: specified in Section 07 26 00 - Vapour Barriers.
- .11 Air barrier: specified in Section 07 27 10 - Air Barriers.

### 2.3 Fabrication

- .1 Fabricate system components with minimum clearances and shim spacing around perimeter of assembly yet enabling installation and dynamic movement of perimeter seal.
- .2 Accurately fit and secure joints and corners. Make joints flush, hairline, and weatherproof.
- .3 Prepare components to receive anchor devices. Install anchors.
- .4 Arrange fasteners and attachments to ensure concealment from view.
- .5 Prepare system components to receive exterior doors, specified in Section 08 11 16.
- .6 Reinforce framing members for external imposed loads.
- .7 Visible manufacturer's identification labels not permitted.

---

2.4 Fabrication: Infill Panels

- .1 Fabricate infill panels with metal covered edge seals around perimeter of panel assembly, enabling installation and minor movement of perimeter seal.
- .2 Reinforce interior surface of exterior panel sheet from deflection caused by wind and suction loads.
- .3 Accurately fit and secure joints and corners. Make joints flush, hairline, and weatherproof.
- .4 Place insulation within panel, adhered to exterior face of interior panel sheet over entire area of sheet with impale fasteners.
- .5 Ventilate and pressure equalize the air space outside the exterior surface of the insulation, to the exterior.
- .6 Arrange fasteners and attachment to ensure concealment from view.

2.5 Finishes

- .1 Finish exposed surfaces of aluminum components in accordance with Aluminum Association Designation System for Aluminum Finishes.
  - .1 Clear Anodic Finish: designation AA-A41 Class 1, 0.018mm minimum thickness.
- .2 Appearance and properties of anodized finishes designated by the Aluminum Association as Architectural Class 1, Architectural Class 2, and Protective and Decorative shall meet requirements of CGSB 63-GP-2M+Amdt-Jul-8 0, for coating Classes 1, 2 and 3 respectively.
- .3 Apply two coats of bituminous paint to concealed aluminum and steel surfaces in contact with cementitious or dissimilar materials.

2.6 Source Quality Control

- .1 Perform work in accordance with AAMA GSM-1 AAMA CW-I-9.
- .2 Installer qualifications: company specializing in performing the work of this section approved by manufacturer.
- .3 Design structural support framing components to CAN/CSA-S157 under direct supervision of a Professional Structural Engineer experienced in design of this Work and licensed in the Province of Ontario.
- .4 Perform welding Work in accordance with CSA W59.2.

**PART 3 - EXECUTION**

3.1 Examination

- .1 Verify dimensions, tolerances, and method of attachment with other work.
- .2 Verify wall openings and adjoining air barrier and vapour retarder materials are ready to receive work of this section.

3.2 Installation

- .1 Install curtain wall system in accordance with manufacturer's instructions.
- .2 Attach to structure to permit sufficient adjustment to accommodate construction tolerances and other irregularities.
- .3 Provide alignment attachments and shims to permanently fasten system to building structure. Clean weld surfaces; apply protective primer to field welds and adjacent surfaces.
- .4 Align assembly plumb and level, free of warp or twist. Maintain assembly dimensional tolerances and align with adjacent work.
- .5 Provide thermal isolation where components penetrate or disrupt building insulation.
- .6 Install sill flashings.

- .7 Pack fibrous insulation in shim spaces at perimeter of assembly to maintain continuity of thermal barrier.
- .8 Install glass and infill panels in accordance with Section 08 80 50 - Glazing, to glazing method required to achieve performance criteria.
- .9 Mechanically secure from rear before assembly, reveal edged 12.7mm gypsum board panels supplied by Section 09 21 16 for curtain walls as indicated on Drawings.
- .10 Install perimeter sealant to method required to achieve performance criteria. Type, backing materials, and installation criteria in accordance with Section 07 92 10 - Joint Sealing.

### 3.3 Site Tolerances

- .1 Maximum variation from plumb: 1.5mm/ metre non-cumulative or 12mm/ 30metre, whichever is less.
- .2 Maximum misalignment of two adjoining members abutting in plane: 0.8mm.
- .3 Maximum sealant space between curtain wall and adjacent construction: 13mm.

### 3.4 Manufacturer's Field Services

- .1 Curtain wall product manufacturers to provide field surveillance of the installation of their Products.
- .2 Monitor and report installation procedures, unacceptable conditions and conflicts.

### 3.5 Cleaning

- .1 Remove protective material from prefinished aluminum surfaces.
- .2 Wash down surfaces with a solution of mild detergent in warm water, applied with soft, clean wiping cloths. Take care to remove dirt from corners. Wipe surfaces clean.
- .3 Remove excess sealant by moderate use of mineral spirits or other solvent acceptable to sealant manufacturer.

### 3.6 Protection

- .1 Protect finished Work from damage.

END OF SECTION

---

**PART 1 - GENERAL**

1.1 General

- .1 Conform to Division 01 - General Requirements.

1.2 Related Sections

- .1 Section 07 92 10 – Joint Sealing.
- .2 Section 08 44 13 – Glazed Aluminum Curtain Walls.
- .3 Section 08 80 50 – Glazing.

1.3 References

- .1 Canadian General Standards Board (CGSB)
  - .1 CAN/CGSB-1.40-97, Primer, Structural Steel, Oil Alkyd Type.
  - .2 CAN/CGSB-79.1-M91, Insect Screens.
- .2 Canadian Standards Association (CSA)
  - .1 CAN/CSA-A440-00 (R2005), Windows.
- .3 North American Fenestration Standard (NAFS-11).

1.4 Approved Manufacturers

- .1 To establish a standard for bidding purposes, the Drawings are based upon Alumicor Limited: Univent 1350 Series projected vents/ hoppers are approved.
- .2 The following manufacturers are approved, subject to total compliance with this Specification:
  - .1 Kawneer Company of Canada Limited.
  - .2 Sherwood Windows Group.
  - .3 Aerloc Industris Ltd.

1.5 Work Included

- .1 Supply and install all factory assembled and prefinished extruded aluminum windows complete with glass and glazing, operable hardware, weatherstripping, screens and all required anchorages, attachments and shims and perimeter weather seals.

1.6 Shop Drawings

- .1 Submit shop drawings in accordance with Section 01 33 00 - Submittal Procedures.
- .2 Indicate materials and details in scale full size for head, jamb and sill, profiles of components, interior and exterior trim junction between combination units elevations of unit, anchorage details, location of isolation coating, description of related components and exposed finishes fasteners, and caulking. Indicate location of manufacturer's nameplates.

1.7 Samples

- .1 Submit samples in accordance with Section 01 33 00 - Submittal Procedures.
- .2 Submit a corner cross section of window, showing sill and jamb section, complete with hardware, weatherstripping, glass, screening, etc. and other items to be used at the windows, including finish(es) of aluminum.

1.8 Test Reports

- .1 Submit test reports from approved independent testing laboratories, certifying compliance with specifications, for:
  - .1 Windows classification to CAN/CSA-A440/ NAFS-11-AW.

- .2 Anodized finish.
- .3 Insect screens.
- .4 Air tightness.
- .5 Water tightness.
- .6 Wind load resistance.
- .7 Condensation resistance.
- .8 Ease of operation - windows with operable lights.
- .9 Forced entry resistance.
- .10 Mullion deflection - combination and composite windows.

#### 1.9 Maintenance Data

- .1 Provide operation and maintenance data for windows for incorporation into manual specified in Section 01 78 00 - Closeout Submittals.
- .2 Arrange with and demonstrate to building maintenance staff window operation, cleaning, reglazing and general maintenance procedures.

#### 1.10 Warranty

- .1 Provide a written warranty, signed and issued in the name of the Owner and Project stating that the contractor, Sub-contractor and/or manufacturer jointly and severally warrant the complete aluminum window system against leakage, defects and malfunction under normal usage in accordance with GC 12.3 as amended by the Supplementary General Conditions, but for a period of:
  - .1 Two years for parts and labour on all components;
  - .2 Three years for caulking against cracking, crumbling, melting, shrinking, running, lose adhesion or stain adjacent surfaces;
  - .3 Five years for the insulating glass units against failure of seal of enclosed air space and deposits on inner faces of glass detrimental to vision;
  - .4 all from the date of Substantial Performance of the Work.

## **PART 2 - PRODUCTS**

### 2.1 Materials

- .1 Sash, frame and screen member: Extruded aluminum alloy 6063-T6, minimum 1.6mm thick.
- .2 Aluminum fixed windows units with thermal break to CAN/CSA-A440 Classification Fixed, B7, C5, I<sub>g</sub>=70, I<sub>f</sub>=69.
- .3 Aluminum operable windows to be compliant with the performance requirements of CAN/CSA-A440 Classification A3, B7, C5 and I=63.
- .4 Exterior/ interior panning: Extruded aluminum alloy 6063-T5, minimum 1.6mm thick.
- .5 Thermal break: Extruded virgin polyvinyl chloride thermo-barrier.
- .6 Weatherstripping: Fin-Seal polypropylene woven pile seal.
- .7 Insect screens: To CAN3-A440-M90, heavy duty, 18 x 14 fiberglass mesh.
- .8 Fasteners: Non-magnetic, stain and corrosion resistant stainless steel to ASTM E-149.
- .9 Exposed surfaces of aluminum components in accordance with Aluminum Association A-A41 Class I, 0.018mm minimum thickness; CLEAR ANODIZED.
- .10 Thermal Insulation:
  - .1 Loose Insulation: glass fibre, density of 12kg/ m<sup>3</sup>, by Fibreglas Canada.
  - .2 Foam Insulation: One or two-part, polyurethane, similar to products produced by BASF Canada Inc.

### 2.2 Glazing

- .1 Refer to Section 08 80 50 - Glazing.
- .2 Glazing materials: wrap around polyvinyl chloride glazing channel.
- .3 Bedding compound: to CGS 19-GP-14M.

- .4 Sealants: to Section 07 92 10, colour to match frames.
- .5 Isolation coating: Alkali resistant bituminous paint.

### 2.3 Fabrication

- .1 Operable windows: Fabricate windows using two separate frames joined by means of a thermal break and as follows:
  - .1 Cope and butt joints in main frame and sash neatly in weather tight manner and secure by means of screws anchored into integral screw ports.
  - .2 Secure sash corners with thread-cutting type screw to ensure tight corners when re-assembling after glass repairs have been made.
  - .3 Internally seal all sash corners.
  - .4 Deburr and make smooth all sharp milled edges and corners of frames.
  - .5 Provide tubular sections for all vertical sash rails, screen frame and sill frame.
  - .6 Provide outside main frame sill with device of exterior sash.
  - .7 Provide sill members with minimum 5° slope.
  - .8 Provide sill weep system which will facilitate drainage of water accumulating in the sill area while preventing passage of air, dirt and insects from exterior to the interior.
  - .9 Fabricate and anchor both inner and outer frames using specified screw fasteners without violating the thermal break.
  - .10 Exposed fasteners or the use of pop rivets is not acceptable.
  - .11 Fabricate entire window in a manner that will allow easy replacement of any defective, damaged, worn components, hardware or weatherstripping.
  - .12 Completely separate all operating surfaces from metal to metal contact.
  - .13 Hardware for operable windows:
    - .1 Hinges: Equip each operable window with one pair stainless steel, four bar friction arm hinges complete with semi-concealed device to adjust operating tension.
    - .2 Locks: Equip each operable unit with two locking claw handles.
  - .14 Provide multiple weatherstripping in perimeters.
- .2 Thermo-Barrier:
  - .1 Provide complete metal to metal separation between the two main frame members.
  - .2 Do not use connecting screws, clips or other devices which would tend to bridge the two frame members or restrict in any manner the expansion and contraction of the individual separate frame members.
  - .3 Factory seal between thermo barrier and frame around perimeter to ensure weather tight assembly.
- .3 Glazing:
  - .1 Provide sash frames which will permit glass replacement without the use of special tools.
- .4 Weatherstripping:
  - .1 Double weatherstrip window units at all sash perimeters
  - .2 Conceal weatherstripping to prevent accumulation of foreign matter due to cleaning, operation or handling which would affect the effective life of the seal.
  - .3 Install all weatherstripping in specially extruded ports and secure to prevent shrinkage, movement or loss when removing sash for cleaning or glass replacement.
- .5 Exterior sills:
  - .1 Provide one piece extruded aluminum sections of type and size to suit job conditions, complete with joint covers, jamb drip deflectors, chairs and anchoring devices.
  - .2 Jamb deflectors to be anchored with concealed fastener.
  - .3 Join sill sections at corners utilizing integral screw ports and screws and back seal.

- .6 Screens:
  - .1 Factory install in tubular extruded aluminum frames and secure in place using vinyl spline.
  - .2 Screen is to be located on interior side of awning type window.
  - .3 Screen guide channels or fins which facilitate the operation of the screen shall be an integral part of the window frame or thermo-barrier.
  - .4 Channels or fins which are surface applied to window frame or thermo-barrier by means of screws or rivets are not acceptable.

#### 2.4 Isolation Coating

- .1 Isolate aluminum from following components, by means of isolation coating:
  - .1 Dissimilar metals except stainless steel, zinc, or white bronze of small area.
  - .2 Concrete, mortar and masonry.
  - .3 Wood.

#### 2.5 Air Barrier and Vapour Retarder

- .1 Equip window frames with site installed air barrier and vapour retarder material for sealing to building air barrier and vapour retarder as follows:
  - .1 Material: identical to, or compatible with, building air barrier and vapour retarder materials to provide required air tightness and vapour diffusion control throughout exterior envelope assembly.
  - .2 Material width: adequate to provide required air tightness and vapour diffusion control to building air barrier and vapour retarder from interior.

### **PART 3 - EXECUTION**

#### 3.1 Preparation

- .1 Protect adjacent surfaces from damage resulting from work under this Specification.

#### 3.2 Installation

- .1 Install in accordance with CAN/CSA-A440 and manufacturer's instructions.
- .2 Arrange components to prevent abrupt variation in colour.
- .3 Erect and secure window units plumb, square and level relative to building structure and free from warp, twist or superimposed loads. Do not exceed 3mm in 3050mm variation from plumb and level.
- .4 Pack loose fill insulation into void between exterior aluminum frame and window opening.
- .5 Seal joints between frame and members and perimeter window openings with sealants to provide weather tight seal outside and air/vapour seal inside.
- .6 Maintain integrity of vapour retarder and air barrier system within systems installed by this Section and between systems and adjoining construction.
- .7 Use concealed fastenings as recommended by manufacturer. Exposed screws, bolts or nut heads are not permitted.
- .8 Secure work adequately and accurately to the structure in the required position, in a manner not restricting thermal and wind movement for windows. Lock all adjacent settings after their alignment.

#### 3.3 Sill Installation

- .1 Install aluminum sills with uniform wash to exterior, level in length, straight in alignment with plumb upstands and faces. Use one piece at each location.
- .2 Cut sills to fit window opening and round exterior corners.
- .3 Secure sills in place with anchoring devices located at end joints of continuous sills and evenly spaced 600mm o.c. in between.



- .4 Fasten expansion joint cover plates and drip deflectors with self tapping stainless steel screws.
- .5 Maintain 6 to 9mm space between butt ends of continuous sills. For sills over 1200mm in length, maintain 3 to 6mm space at each end.

### 3.4 Caulking

- .1 Supply and install sealant at perimeters of aluminum windows between frames and interior/exterior building components to Section 07 92 10.
- .2 Caulk joints between frame members and other non-operating components to provide weather tight seal at outside and air/vapour seal at inside.
- .3 Seal joints between windows and window sills with sealant. Bed sill expansion joint cover plates and drip deflectors in bedding compound. Caulk between sill upstand and window-frame. Caulk butt joints in continuous sills
- .4 Apply sealant in accordance with Section 07 92 10 - Joint Sealing. Conceal sealant within aluminum work except where exposed use is permitted by Consultant.
- .5 Caulk joints between mullions, frames, rails and sills as required for weatherproof installation.
- .6 Provide aluminum panning if caulk joint is larger than 12mm.

### 3.5 Clean Up

- .1 Upon completion, provide final cleaning of glass and frames.
- .2 Leave surfaces clean, free from labels, sealants and dirt.

END OF SECTION

---

**PART 1 - GENERAL**

1.1 General

- .1 Conform to Division 01 - General Requirements.

1.2 Related Sections

- .1 Section 08 44 13 – Glazed Aluminum Curtain Walls.
- .2 Section 08 50 50 – Aluminum Windows.

1.3 References

- .1 American Society for Testing and Materials (ASTM)
  - .1 ASTM C542 – 05(2017), Specification for Lock-Strip Gaskets.
  - .2 ASTM E330-02, Test Method for Structural Performance of Exterior Windows, Curtain Walls and Doors by Uniform Static Air Pressure Difference.
- .2 Canadian Door and Window Manufacturers, Certification Program.
- .3 Canadian General Standards Board (CGSB)
  - .1 CAN/CGSB-12.1-2017, Tempered or Laminated Safety Glass.
  - .2 CAN/CGSB-12.2-M91 (R2017), Flat, Clear Sheet Glass.
  - .3 CAN/CGSB-12.3-M91 (R2017), Flat, Clear Float Glass.
  - .4 CAN/CGSB-12.4-M91 (R2017), Heat Absorbing Glass.
  - .5 CAN/CGSB-12.5-M86, Mirrors, Silvered.
  - .6 CAN/CGSB-12.8-2017, Insulating Glass Units.
  - .7 CAN/CGSB-12.9-M91, Spandrel Glass.
  - .8 CAN/CGSB-12.10-M76, Glass, Light and Heat Reflecting.
- .4 Canadian Standards Association (CSA)
  - .1 CSA A440.2-14, Energy Performance Evaluation of Windows and Sliding Glass Doors.
- .5 North American Fenestration Standard (NAFS-11).
- .6 Flat Glass Manufacturers Association (FGMA), Glazing Manual
- .7 Laminators Safety Glass Association, Standards Manual.

1.4 Performance Requirements

- .1 Provide continuity of building enclosure vapour and air barrier using glass and glazing materials as follows:
  - .1 Utilize inner light of multiple light sealed units for continuity of air and vapour seal.
- .2 Size glass to withstand wind loads, dead loads and positive and negative live loads as measured in accordance with ANSI/ASTM E 330.

1.5 Shop Drawings

- .1 Submit shop drawings in accordance with Section 01 33 00 - Submittal Procedures.

1.6 Samples

- .1 Submit samples in accordance with Section 01 33 00 - Submittal Procedures.
- .2 Submit duplicate 300mm x 300mm size samples of glass types.

1.7 Closeout Submittals

- .1 Provide maintenance data including cleaning instructions for incorporation into manual specified in Section 01 78 00 – Closeout Submittals.

1.8 Quality Assurance

- .1 Perform work in accordance with FGMA Glazing Manual IGMAC and Laminators Safety Glass Association - Standards Manual for glazing installation methods.

1.9 Environmental Requirements

- .1 Install glazing when ambient temperature is 10°C minimum. Maintain ventilated environment for 24 hours after application.
- .2 Maintain minimum ambient temperature before, during and 24 hours after installation of glazing compounds.

**PART 2 - PRODUCTS**

2.1 Materials: Flat Glass

- .1 Safety glass: to CAN/CGSB-12.1, transparent, 6mm thick.
  - .1 Type 2-tempered.
  - .2 Class B-float.

2.2 Materials: Sealed Insulating Glass

- .1 Insulating glass units: to CAN/CGSB-12.8, double unit.
  - .1 Glass: to CAN/CGSB-12.1; safety glass.
  - .2 Glass thickness: 6mm each light.
  - .3 Inter-cavity space thickness: 12.5mm between lights w/ low conductivity spacer.
  - .4 Glass coating: surface number 3, low "E".
    - .1 Acceptable material: Solarban 60 as manufactured by Vitro, or alternate, providing minimum Winter U value of 0.29, solar heat gain co-efficient of 0.39, and visible light transmittance of 70%.
  - .5 Cavity: Argon filled.
  - .6 Colour:
    - .1 Exterior Pane: MATCH EXISTING (SOLAR GREY).
    - .2 Interior Pane: CLEAR.
- .2 Opaque insulating glass units (Spandrel): to CAN2-12.9M; double unit.
  - .1 Glass: to CAN/CGSB-12.1; safety glass.
  - .2 Glass thickness: 6mm each light.
  - .3 Inter-cavity space thickness: 12.5mm between lights w/ low conductivity spacer.
  - .4 Glass coating: surface number 4.
    - .1 Acceptable material: Opaci-coat 300 by ICD High Performance Coatings, custom colours (refer to Drawings for number of colours to be provided).
  - .5 Cavity: Argon filled.
  - .6 Colour:
    - .1 Exterior Pane: CLEAR.
    - .2 Interior Pane: CLEAR.

2.3 Materials

- .1 Sealant: to glass manufacturers standard.
  - .1 Acceptable material: ECP-45.

2.4 Accessories

- .1 Setting blocks: Neoprene, 80-90 Shore A durometer hardness to ASTM D2240, to suit glazing method, glass light weight and area.

- .2 Spacer shims: Neoprene, 50-60 Shore A durometer hardness to ASTM D2240, 75mm long x one half height of glazing stop x thickness to suit application. Self adhesive on one face.
- .3 Glazing tape: Preformed butyl, 10-15 Shore A durometer hardness to ASTM D2240; coiled on release paper; 3 x 13mm size; black colour.
- .4 Lock-strip gaskets: to ASTM C542.

### **PART 3 - EXECUTION**

#### 3.1 Examination

- .1 Verify that openings for glazing are correctly sized and within tolerance.
- .2 Verify that surfaces of glazing channels or recesses are clean, free of obstructions, and ready to receive glazing.

#### 3.2 Preparation

- .1 Clean contact surfaces with solvent and wipe dry.
- .2 Seal porous glazing channels or recesses with substrate compatible primer or sealer.
- .3 Prime surfaces scheduled to receive sealant.

#### 3.3 Installation: Exterior - Dry Method (Preformed Glazing)

- .1 Cut glazing tape to length; install on glazing light. Seal corners by butting tape and sealing junctions with sealant.
- .2 Place setting blocks at 1/4 points, with edge block maximum 150mm from corners.
- .3 Rest glazing on setting blocks and push against fixed stop with sufficient pressure to attain full contact.
- .4 Install removable stops without displacing glazing tape spline. Exert pressure for full continuous contact.
- .5 Trim protruding tape edge.

#### 3.4 Installation: Exterior Wet/Dry Method (Preformed Tape and Sealant)

- .1 Cut glazing tape to length and set against permanent stops, 6mm below sight line. Seal corners by butting tape and dabbing with sealant.
- .2 Apply heel bead of sealant along intersection of permanent stop with frame ensuring full perimeter seal between glass and frame to complete continuity of air and vapour seal.
- .3 Place setting blocks at 1/4 points, with edge block maximum 150mm from corners.
- .4 Rest glazing on setting blocks and push against tape and heel head of sealant with sufficient pressure to attain full contact at perimeter of light or glass unit.
- .5 Install removable stops with spacer strips inserted between glazing and applied stops 6mm below sight line. Place glazing tape on glazing light or unit with tape flush with 16mm below sight line.
- .6 Fill gap between glazing and stop with sealant to depth equal to bite of frame on glazing, maximum 9mm below sight line.
- .7 Apply cap head of sealant along void between stop and glazing, to uniform line, flush with sight line. Tool or wipe sealant surface smooth.

#### 3.5 Installation: Interior - Dry Method (Tape and Tape)

- .1 Cut glazing tape to length and set against permanent stops, projecting 1.6mm above sight line.
- .2 Place setting blocks at 1/4 points, with edge block maximum 150mm from corners.

- .3 Rest glazing on setting blocks and push against tape for full contact at perimeter of light or unit.
- .4 Place glazing tape on free perimeter of glazing in same manner described.
- .5 Install removable stop without displacement of tape. Exert pressure on tape for full continuous contact.
- .6 Knife trim protruding tape.

### 3.6 Protection

- .1 Provide safety markings to installed glass by attaching streamers or tape to face of sash. Do not apply tape directly to glass. Do not mark the glass with paint or any other substance that is hard to remove or could leave permanent stains.
- .2 Take all precautions necessary to protect stored glass and installed glass from lime mortar, water run-off from concrete or copper, weld splatter, acids, roofing tar, solvents, abrasive cleaners, careless handling of construction machinery and equipment, and any other activities that could permanently damage the glass.
- .3 Install protective cover to glass where there is a high risk of damage. Use plywood, heavy kraft paper, or non-staining transparent plastic sheet. Do NOT let protective materials contact surface of glass.
- .4 Do not rely on use of adhesive plastic films to protect installed glass. When plastic is sheeting is used, it must be transparent, suspended away from the surface of the glass, and be provided with adequate ventilation holes to prevent heat build-up.

### 3.7 Cleaning

- .1 Remove glazing materials from finish surfaces.
- .2 Remove labels after work is complete.
- .3 Clean all glass and mirrors.
- .4 Remove and replace glass that is broken, chipped, cracked, abraded or damaged in other ways during construction period, including natural causes, accidents and vandalism.

END OF SECTION

---

**PART 1 - GENERAL**

1.1 General

- .1 Conform to Division 01 – General Requirements.

1.2 Related Sections

- .1 Section 07 92 10 – Joint Sealing.
- .2 Section 09 22 14 – Metal Furring and Lathing.
- .3 Section 09 22 16 – Non-Structural Metal Framing.
- .4 Section 09 22 27 – Acoustical Suspension.
- .5 Section 09 91 10 – Painting.
- .6 Divisions 21-23 – Mechanical.
- .7 Divisions 26-28 – Electrical.

1.3 References

- .1 Aluminum Association
  - .1 Designation for Aluminum Finishes.
- .2 American Society for Testing and Materials (ASTM)
  - .1 ASTM C36, Specification for Gypsum Wallboard.
  - .2 ASTM C79, Specification for Gypsum Sheathing Board.
  - .3 ASTM C442, Specification for Gypsum Backing Board and Coreboard.
  - .4 ASTM C475, Specification for Joint Compound and Joint Tape for Finishing Gypsum Board.
  - .5 ASTM C514, Specification for Nails for the Application of Gypsum Board.
  - .6 ASTM C557, Specification for Adhesives for Fastening Gypsum Wallboard to Wood Framing.
  - .7 ASTM C630, Specification for Water-Resistant Gypsum Backing Board.
  - .8 ASTM C840, Specification for Application and Finishing of Gypsum Board.
  - .9 ASTM C931/931, Specification for Exterior Gypsum Soffit Board.
  - .10 ASTM C954, Specification for Steel Drill Screws for the Application of Gypsum Board.
  - .11 ASTM C960, Specification for Predecorated Gypsum Board.
  - .12 ASTM C1002, Specification for Steel Drill Screws for the Application of Gypsum Board or Metal Plaster Bases.
  - .13 ASTM C1047, Specification for Accessories for Gypsum Wallboard and Gypsum Veneer Base.
  - .14 ASTM C1280, Specification for Application of Gypsum Sheathing Board.
  - .15 ASTM C1177, Specification for Glass Mat Gypsum Substrate for Use as Sheathing.
  - .16 ASTM C1178, Specification for Glass Mat Water-Resistant Gypsum Backing Board.
- .3 Canadian General Standards Board (CGSB)
  - .1 CAN/CGSB-51.34-M, Vapour Barrier, Polyethylene Sheet for Use in Building Construction.
  - .2 CAN/CGSB-71.25-M, Adhesive, for Bonding Drywall to Wood Framing and Metal Studs.
- .4 Underwriters Laboratories of Canada (ULC)
  - .1 CAN/ULC-S102, Building Materials and Assemblies, Standard Method of Test for Surface Burning Characteristics of Building Materials and Assemblies.
- .5 Gypsum Association (GA)
  - .1 GA-216, Application and Finishing of Gypsum Board.
  - .2 GA-600, Fire Resistance Design Manual.

1.4 Samples

- .1 Submit samples in accordance with Section 01 33 00 - Submittal Procedures.
- .2 Submit 300mm long samples of corner and casing beads and reveals.

1.5 Site Environmental Requirements

- .1 Maintain temperature minimum 15°C, maximum 21°C for 48 hours prior to and during application of gypsum boards and joint treatment, and for at least 48 hours after completion of joint treatment.
- .2 Apply board and joint treatment to dry, frost free surfaces.

1.6 Quality Assurance

- .1 Subcontractor executing the Work of this Section shall have adequate plant, equipment and skilled tradesmen to provide installations of work of this type and quality indicated and specified.
- .2 Single source responsibility: Obtain gypsum board products from single manufacturer, or from manufacturers recommended by prime manufacturer of gypsum boards.
- .3 Fire resistance rating: Where gypsum board systems with fire resistance ratings are indicated or required, provide materials and installations that are identical with those of applicable assemblies tested by fire testing laboratories acceptable to authorities having jurisdiction.

**PART 2 - PRODUCTS**

2.1 Materials

- .1 Fire resistant board (GB): Type X to ULC Guide No. 40 U18.23, thickness as noted on drawings, 1220mm wide x maximum practical length, ends square cut, edges tapered.
- .2 Glass mat wall board (GB): to ASTM C1177 regular, 15.9mm thick, 1220mm wide x maximum practical length, ends square cut, edges tapered, glass mat faced, water resistant treated core.
  - .1 Acceptable material:
    - .1 Georgia Pacific 'DensArmor Plus High Performance Interior Panel'.
    - .2 CGC Sheetrock Glass Mat Mold Tough.
- .3 Impact resistant glass mat wall board (GB): to ASTM C1177 regular, 15.9mm thick, 1220mm wide x maximum practical length, ends square cut, edges tapered, glass mat faced, water resistant treated core.
  - .1 Acceptable material:
    - .1 Georgia Pacific 'DensArmor Plus Impact-Resistant Interior Panel'.
    - .2 CGC Sheetrock Glass Mat Mold Tough.
- .4 Metal furring runners, hangers, tie wires, inserts, anchors: to ASTM C841.
- .5 Drywall furring channels: 0.5mm core thickness galvanized steel channels for screw attachment of gypsum board.
- .6 Resilient clips drywall furring: 0.5mm base steel thickness galvanized steel for resilient attachment of gypsum board.
- .7 Steel drill screws: to ASTM C1002.
- .8 Stud adhesive: to CAN/CGSB-71.25 ASTM C557.
- .9 Laminating compound: as recommended by manufacturer, asbestos-free.
- .10 Casing beads, corner beads, control joints and edge trim: to ASTM C1047, Zinc metal, zinc-coated by electrolytic process, 0.5mm base thickness, perforated flanges, one piece length per location.
- .11 Reveal joints: rigid PVC, sizes as indicated on Drawings.
  - .1 Acceptable manufacturer:
    - .1 Trimtex, or approved alternate.

- .12 Sealants: in accordance with Section 07 92 00 - Joint Sealing.
- .13 Acoustic sealant: Refer to Section 07 92 00.
- .14 Polyethylene: to CAN/CGSB-51.34, Type 2.
- .15 Insulating strip: rubberized, moisture resistant, 3mm thick closed cell neoprene strip, 12mm wide, with self sticking permanent adhesive on one face, lengths as required.
- .16 Joint reinforcement tape: 50mm wide, glass fibre mesh.
- .17 Joint compound: to ASTM C475, asbestos-free.

### **PART 3 - EXECUTION**

#### 3.1 Erection

- .1 Do application and finishing of gypsum board in accordance with ASTM C840 except where specified otherwise.
- .2 Erect hangers and runner channels for suspended gypsum board ceilings in accordance with ASTM C840 except where specified otherwise.
- .3 Support light fixtures by providing additional ceiling suspension hangers within 150mm of each corner and at maximum 600mm around perimeter of fixture.
- .4 Install work level to tolerance of 1:1200.
- .5 Frame with furring channels, perimeter of openings for access panels, light fixtures, diffusers, grilles, etc.
- .6 Install furring channels parallel to, and at exact locations of steel stud partition header track.
- .7 Furr for gypsum board faced vertical bulkheads within and at termination of ceilings.
- .8 Furr above suspended ceilings for gypsum board fire and sound stops and to form plenum areas as indicated.
- .9 Install wall furring for gypsum board wall finishes in accordance with ASTM C840, except where specified otherwise.
- .10 Furr openings and around built-in equipment, cabinets, access panels, on four sides. Extend furring into reveals. Check clearances with equipment suppliers.
- .11 Furr duct shafts, beams, columns, pipes and exposed services where indicated.
- .12 Erect drywall resilient furring transversely across studs, spaced maximum 600mm o.c. and not more than 150mm from ceiling/wall juncture. Secure to each support with 25mm drywall screw.
- .13 Install 150mm continuous strip of 12.7mm gypsum board along base of partitions where resilient furring installed.

#### 3.2 Application

- .1 Do not apply gypsum board until bucks, anchors, blocking, electrical and mechanical work are approved.
- .2 Apply single layer gypsum board to metal furring or framing using screw fasteners. Maximum spacing of screws 300mm o.c.
- .3 Apply single layer gypsum board to concrete/ concrete block surfaces, where indicated, using laminating adhesive.
- .4 **Apply impact resistant glass mat wall board on interior walls, full height.**
- .5 **Apply glass mat wall board in all other locations.**
- .6 Apply 12mm diameter bead of acoustic sealant continuously around periphery of each face of partitioning to seal gypsum board/structure junction where partitions abut fixed building components. Seal full perimeter of cut-outs around electrical boxes, ducts, etc., in partitions where perimeter sealed with acoustic sealant.



### 3.3 Installation

- .1 Erect accessories straight, plumb or level, rigid and at proper plane. Use full length pieces where practical. Make joints tight, accurately aligned and rigidly secured. Mitre and fit corners accurately, free from rough edges. Secure at 150mm oc.
- .2 Install casing beads around perimeter of suspended ceilings.
- .3 Install casing beads where gypsum board butts against surfaces having no trim concealing junction and where indicated. Seal joints with sealant.
- .4 Install insulating strips continuously at edges of gypsum board and casing beads abutting metal window and exterior door frames, to provide thermal break.
- .5 Construct control joints of preformed units set in gypsum board facing and supported independently on both sides of joint.
- .6 Provide continuous polyethylene dust barrier behind and across control joints.
- .7 Locate control joints where indicated on Drawings, at changes in substrate construction, **and** at approximate 10m spacing on long corridor runs and at approximate 15m spacing on ceilings. **Submit layout of control joints to Consultant for approval prior to commencement of the Work of this Section.**
- .8 Install control joints straight and true.
- .9 Install access doors to electrical and mechanical fixtures specified in respective Sections.
  - .1 Rigidly secure frames to furring or framing systems.
- .10 Finish face panel joints and internal angles with joint system consisting of joint compound, joint tape and taping compound installed according to manufacturer's directions and feathered out onto panel faces.
- .11 Finish corner beads, control joints and trim as required with two coats of joint compound and one coat of taping compound, feathered out onto panel faces.
- .12 Fill screw head depressions with joint and taping compounds to bring flush with adjacent surface of gypsum board so as to be invisible after surface finish is completed.
- .13 Sand lightly to remove burred edges and other imperfections. Avoid sanding adjacent surface of board.
- .14 Completed installation to be smooth, level, plumb, free from waves and other defects and ready for surface finish.
- .15 Mix joint compound slightly thinner than for joint taping.
- .16 Where required by surface imperfections, apply thin coat to entire surface using trowel or drywall broad knife to fill surface texture differences, variations or tool marks.
- .17 Allow skim coat to dry completely.
- .18 Remove ridges by light sanding or wiping with damp cloth.

### 3.4 Fire Dampers

- .1 Refer to Mechanical Drawings for locations of fire dampers.
- .2 Coordinate opening sizes for dampers to ULC clearance requirements.
- .3 Line openings for dampers with type X board prior to damper installation.

### 3.5 Cleaning

- .1 Clean adjacent surfaces and remove excess materials, droppings and debris.
- .2 Protect unfinished work.

END OF SECTION

## **PART 1 - GENERAL**

### 1.1 General

- .1 Conform to Division 01 – General Requirements.

### 1.2 Related Sections

- .1 Section 09 21 16 – Gypsum Board Assemblies.
- .2 Section 09 22 27 – Acoustical Suspension.
- .3 Divisions 21-23/ 26-28: Access doors and plaster rings.

### 1.3 References

- .1 American Society for Testing and Materials (ASTM)
  - .1 ASTM C841, Standard Specification for Installation of Interior Lathing and Furring.
  - .2 ASTM C847, Standard Specification for Metal Lath.
  - .3 ASTM C1047, Accessories for Gypsum Wallboard and Gypsum Veneer.
- .2 Canadian General Standards Board (CGSB)
  - .1 CAN/CGSB-51.34-M, Vapour Barrier, Polyethylene Sheet for Use in Building Construction.
- .3 Canadian Standards Association (CSA)
  - .1 CSA A123.3, Asphalt Saturated Organic Roofing Felt.

## **PART 2 - PRODUCTS**

### 2.1 Materials

- .1 Metal furring (channels, hangers, tie wire, inserts, anchors): ASTM C841.
- .2 Polyethylene film: CAN/CGSB-51.34, Type 2, 0.15mm thick.
  - .1 Acceptable material: ECP-69.
- .3 Metal accessories (corner beads, base screeds, cornerite, casing beads): ASTM C1047.

## **PART 3 - EXECUTION**

### 3.1 Preparation

- .1 Use galvanized supports, members, angles and metal lathing in wet areas, exterior walls and exterior soffits.
- .2 Do not lath over bucks, anchors, blocking, electrical and mechanical work until they are inspected and approved by Consultant.
- .3 Leave finished work rigid, secure, square, level, plumb, and erected to maintain finish plaster line dimensions and contours. Make allowance for thermal movement.
- .4 Provide clearance under beams and structural slabs to prevent transmission of structural loads to vertical furring.

---

### 3.2 Installation

- .1 Furring and lathing work: in accordance with ASTM C841 except as specified otherwise.
- .2 Ceiling Furring.
  - .1 Install runners level to tolerance of 3mm over 3.5m. Provide runners at interruptions of continuity and change in direction.
  - .2 Frame with furring channels, perimeter of openings to accommodate access panels, light fixtures, diffusers, grilles.
  - .3 Furr for vertical bulkheads within or at termination of ceilings.
  - .4 Furr above suspended ceilings for fire and sound stops and to form plenum areas indicated.
  - .5 Brace suspension for exterior soffits and entrance vestibule ceilings to prevent upward movements due to wind pressure.
  - .6 Provide galvanized drips continuously along edges of exterior soffits.
- .3 Wall Furring.
  - .1 Install steel furring for braced walls as indicated.
  - .2 Frame openings and around built-in equipment, cabinets, access panels, on four sides, with channels. Extend furring into reveals. Check clearances with equipment suppliers.
  - .3 Construct bulkheads and boxed-in duct shafts, for beams, columns, pipes and around exposed services where indicated. Install 19mm channels at corners and at 300mm o.c.
  - .4 Build in hollow metal frames in plastered furred walls.

### 3.3 Construction

- .1 Erect accessories straight, plumb or level, rigid and at proper plane. Use full length pieces where practical. Make joints tight, accurately aligned and rigidly secured. Mitre and fit corners accurately, free from rough edges. Secure at 200mm o.c.
- .2 Install corner beads on external angles.
- .3 Install casing beads at perimeter of suspended plaster ceilings; wherever plaster abuts or joins a dissimilar exposed surface such as masonry, concrete, wood, metal; where edges of plaster are exposed; where plaster on a non-structural member butts plaster on a structural member; and elsewhere as indicated.
- .4 Install metal screeds at top of bases and dadoes.
- .5 Construct control joints of special purpose fabrication supported independently on both sides of joint.
- .6 Locate control joints where indicated at wall juncture with suspended ceilings at changes in substrate construction at line of door jambs from top of door frame to ceiling at maximum 7.5m spacing in each direction on ceilings.
- .7 Install control joints straight and true.
- .8 Install rings and frames for electrical and mechanical fixtures.
- .9 Rigidly secure rings and frames to furring and lathing systems.

END OF SECTION

## **PART 1 - GENERAL**

### 1.1 General

- .1 Conform to Division 01 – General Requirements.

### 1.2 Related Sections

- .1 Section 07 92 10 – Joint Sealing.
- .2 Section 09 21 16 – Gypsum Board Assemblies.
- .3 Section 09 22 14 – Metal Furring and Lathing.

### 1.3 References

- .1 American Society for Testing and Materials (ASTM)
  - .1 ASTM C645 - 14e1, Standard Specification for Nonstructural Steel Framing Members.
  - .2 ASTM C754 - 18, Standard Specification for Installation of Steel Framing Members to Receive Screw-Attached Gypsum Panel Products.
- .2 CAN/CGSB-19.21-M87, Sealing and Bedding Compound Acoustical.

## **PART 2 - PRODUCTS**

### 2.1 Materials

- .1 Non-load bearing channel stud framing: to ASTM C645, stud size as indicated on drawings, roll formed with minimum base steel thickness 0.455mm of hot dipped galvanized steel sheet, for screw attachment of gypsum board. Knock-out service holes at 460mm centres. **For walls over 3000mm in height, minimum base steel thickness to be 0.836mm.**
- .2 Floor and ceiling tracks: to ASTM C645, in widths to suit stud sizes, 32mm flange height.
- .3 Metal channel stiffener: 19mm x 9.5mm size, 1.4mm thick cold rolled steel, coated with rust inhibitive coating.
- .4 Acoustical sealant: to CAN/CGSB-19.21. Refer also to Section 07 92 00.
- .5 Insulating strip: rubberized, moisture resistant 3mm thick foam strip, 12mm wide, with self sticking adhesive on one face, lengths as required.

## **PART 3 - EXECUTION**

### 3.1 Erection

- .1 Align partition tracks at floor and ceiling and secure at 600mm o.c. maximum. Allow for 20mm deflection of floor and roof slabs.
- .2 Install dampproof course under stud shoe tracks of partitions on slabs on grade.
- .3 Place studs vertically at 400mm o.c. and not more than 50mm from abutting walls, and at each side of openings and corners. Position studs in tracks at floor and ceiling. Cross brace steel studs as required to provide rigid installation to manufacturer's instructions.
- .4 Erect metal studding to tolerance of 1:1000.
- .5 Attach studs to bottom and ceiling track using screws.

- 
- .6 Co-ordinate simultaneous erection of studs with installation of service lines. When erecting studs ensure web openings are aligned.
  - .7 Co-ordinate erection of studs with installation of door/ window frames and special supports or anchorage for work specified in other Sections.
  - .8 Provide two studs extending from floor to ceiling at each side of openings wider than stud centres specified. Secure studs together, 50mm apart using column clips or other approved means of fastening placed alongside frame anchor clips.
  - .9 Install heavy gauge single jamb studs at openings.
  - .10 Erect track at head of door/ window openings and sills of sidelight/ window openings to accommodate intermediate studs. Secure track to studs at each end, in accordance with manufacturer's instructions. Install intermediate studs above and below openings in same manner and spacing as wall studs.
  - .11 Frame openings and around built-in equipment, cabinets, access panels, on four sides. Extend framing into reveals. Check clearances with equipment suppliers.
  - .12 Provide 40mm stud or furring channel secured between studs for attachment of fixtures behind lavatory basins, toilet and bathroom accessories, and other fixtures including grab bars and towel rails, attached to steel stud partitions.
  - .13 Install steel studs or furring channel between studs for attaching electrical and other boxes.
  - .14 Extend **all** partitions to underside of structural deck.
  - .15 Maintain clearance under beams and structural slabs to avoid transmission of structural loads to studs. Use 50mm leg ceiling deflection tracks, with 75mm leg top track within. Attach studs to 75mm track.
  - .16 Install continuous insulating strips to isolate studs from uninsulated surfaces.
  - .17 Install two continuous beads of acoustical sealant under studs and tracks around perimeter of **all** partitions.

END OF SECTION

---

## **PART 1 - GENERAL**

### 1.1 General

- .1 Conform to Division 01 - General Requirements.

### 1.2 Related Sections

- .1 Section 09 21 16 – Gypsum Board Assemblies.
- .2 Section 09 51 13 – Acoustical Ceilings.
- .3 Divisions 21-23 – Mechanical: Trim for recessed mechanical fixtures.
- .4 Divisions 26-28 – Electrical: Trim for recessed electrical fixtures.

### 1.3 References

- .1 ASTM C635/ C635M - 17, Specifications for the Manufacture, Performance and Testing of Metal Suspension Systems for Acoustical Tile and Lay-In Panel Ceilings.
- .2 ASTM C636 / C636M - 13, Practice for Installation of Metal Ceiling Suspension Systems for Acoustical Tile and Lay-In Panels.

### 1.4 Design Requirements

- .1 Maximum deflection: 1/360th of span to ASTM C635 deflection test.

### 1.5 Extra Materials

- .1 Provide maintenance materials of acoustic tile ceiling panels in accordance with Section 01 78 00 - Closeout Submittals.
- .2 Provide 2% of each colour, pattern and type ceiling tile required for this project for maintenance use.
- .3 Extra materials to be from same production run as installed materials.
- .4 Clearly identify each container of ceiling tile.
- .5 Deliver to site, upon completion of the work of this section.
- .6 Store where directed by Consultant.

## **PART 2 - PRODUCTS**

### 2.1 Materials

- .1 Intermediate duty system to ASTM C 635.
- .2 Basic materials for suspension system: commercial quality cold rolled steel zinc-coated.
- .3 Suspension system: non fire rated, for acoustical ceilings, made up as follows:
  - .1 main tees:
    - .1 0.53mm thick cold rolled steel, double web, with rectangular bulb section at least 38mm high. Fabricate with punched cross tee holes at not greater than 150mm o.c. and hanger wire holes at 50mm o.c. Exposed flange shall be 23.8mm wide cold rolled steel.
  - .2 cross tees:
    - .1 double web design with rectangular bulb, web extending to form a positive interlock with main tees, lower flange extended and offset to provide a flush intersection.
  - .3 Exposed tee bar grid components: die cut, shop painted satin sheen white.
  - .4 Acceptable material: "Prelude" by Armstrong or equivalent system approved by Consultant.

- .4 Suspension system: fire rated, for acoustical ceilings, made up as follows:
  - .1 main tees:
    - .1 0.53mm thick cold rolled steel, double web, with rectangular bulb section at least 43mm high. Fabricate with punched cross tee holes at not greater than 150mm o.c. and hanger wire holes at 50mm o.c. Exposed flange shall be 23.8mm wide cold rolled steel.
  - .2 cross tees:
    - .1 double web design with rectangular bulb, web extending to form a positive interlock with main tees, lower flange extended and offset to provide a flush intersection.
  - .3 Exposed tee bar grid components: die cut, shop painted satin sheen white.
  - .4 Acceptable material: "Prelude XL Fireguard" by Armstrong or equivalent system approved by Consultant.
- .5 Suspension system: non fire rated for gypsum board ceilings, made up as follows:
  - .1 main beams:
    - .1 0.53mm thick cold rolled steel, double web, with peaked roof top bulb at least 42.8mm high. Fabricate with punched cross tee holes at not greater than 150mm o.c. and hanger wire holes at 50mm o.c. Flange shall be 38mm wide knurled cold rolled steel.
  - .2 cross tees:
    - .1 double web design with peaked roof top bulb 38mm high, web extending to form a positive interlock with main tees. Flange shall be 38mm wide knurled cold rolled steel.
  - .3 Acceptable manufacturer: Armstrong or equivalent system approved by Consultant.
- .6 Hanger wire: galvanized soft annealed steel wire.
  - .1 3.6mm diameter to support max. weight of 110 kg/hanger.
  - .2 2.6mm diameter to support max. weight of 68 kg/hanger.
  - .3 galvanized annealed steel rod: 4.8mm diameter to support max. weight of 250kg/hanger.
- .7 Hanger inserts: purpose made.
- .8 Accessories: splices, clips, wire ties, retainers, and angle wall moulding.

### **PART 3 - EXECUTION**

#### **3.1 Installation**

- .1 Installation: in accordance with ASTM C636 except where specified otherwise.
- .2 Install suspension system to manufacturer's instructions and Certification Organizations tested design requirements.
- .3 Install fire rated grid system in ceilings requiring a fire rating, as noted on Drawings.
- .4 Do not erect ceiling suspension system until work above ceiling has been inspected by Consultant.
- .5 Secure hangers to overhead structure. Do not use fasteners that will fracture structural members.
- .6 Install hangers spaced at maximum 1200mm centres and within 150mm from ends of main tees.
- .7 Lay out centre line of ceiling both ways, to provide balanced borders at room perimeter with border units not less than 50% of standard unit width if no reflected ceiling plan is provided.
- .8 Ensure suspension system is co-ordinated with location of related components.
- .9 Install wall moulding and trim to provide correct ceiling height.
- .10 Completed suspension system to support super-imposed loads, such as lighting fixtures diffusers, grilles and speakers.

- .11 Support at light fixtures and diffusers with additional ceiling suspension hangers within 150mm of each corner and at maximum 600mm around perimeter of fixtures.
  - .12 Interlock cross member to main runner to provide rigid assembly.
  - .13 Frame at openings for light fixtures, air diffusers, speakers and at changes in ceiling heights.
  - .14 Finished ceiling system to be square with adjoining walls and level within 1:1000.
- 3.2 Cleaning
- .1 Touch up scratches, abrasions, voids and other defects in painted surfaces.

END OF SECTION



## **PART 1 - GENERAL**

### 1.1 General

- .1 Conform to Division 01 - General Requirements.

### 1.2 Related Sections

- .1 Section 09 21 16 – Gypsum Board Assemblies.
- .2 Section 09 22 27 – Acoustical Suspension.
- .3 Divisions 21-23 – Mechanical.
- .4 Divisions 26-28 – Electrical.

### 1.3 Samples

- .1 Submit samples in accordance with Section 01 33 00 - Submittal Procedures.
- .2 Submit duplicate full size samples of acoustical units.

### 1.4 Environmental Requirements

- .1 Permit wet work to dry before commencement of installation.
- .2 Maintain uniform minimum temperature of 15°C and humidity of 20-40% before and during installation.
- .3 Store materials in work area 48 hours prior to installation.

### 1.5 Extra Materials

- .1 Provide extra materials of acoustic units in accordance with Section 01 78 00 - Closeout Submittals.
- .2 Provide acoustical units amounting to 2% of gross ceiling area for each pattern and type required for project.
- .3 Extra materials to be from same production run as installed materials.
- .4 Clearly identify each type of acoustic unit, including colour and texture.
- .5 Deliver to Owner, upon completion of the work of this section.
- .6 Store as directed on site.

## **PART 2 - PRODUCTS**

### 2.1 Materials

- .1 Acoustic Units for suspended ceiling system:
  - .1 ACT; Minaboard, Dune Fireguard, white, square edge, 610mm x 1220mm x 15.9mm, by Armstrong World Industries, Product Number 1851.
  - .2 Acceptable Alternatives: CertainTeed, or Canadian Gypsum Company Limited; to match specified products.

**PART 3 - EXECUTION**

3.1 Examination

- .1 Do not install acoustical panels and tiles until work above ceiling has been inspected by Consultant.

3.2 Installation

- .1 Install acoustical panels in ceiling suspension system.

3.3 Application

- .1 Install acoustical units parallel to building lines with edge unit not less than 50% of unit width. Refer to Reflected Ceiling Plans.
- .2 Remove damaged and badly marked units and replace with new unmarked material.
- .3 Install components to form a level ceiling with all parts flush and true, parallel to the module lines and the pattern shown. Install panels in level, uniform plane free from twist, warp, dents and flush, without gaps. Fit border units neatly against abutting surfaces.
- .4 Scribe acoustic units to fit adjacent work. Butt joints tight, terminate edges with moulding.
- .5 Install retention clips at each panel as indicated in Room finish Schedule. Adapt installation to provide ceiling access where required for services.

3.4 Interface with Other Work

- .1 Co-ordinate ceiling work to accommodate components of other sections, such as light fixtures, diffusers, speakers, sprinkler heads, to be built into acoustical ceiling components.

3.5 Cleaning

- .1 After installation, clean and touch up minor surface defects on acoustical tile.
- .2 Remove damaged and badly marked units and replace with new unmarked material.

END OF SECTION

## **PART 1 - GENERAL**

### 1.1 General

- .1 Conform to Division 01 - General Requirements.

### 1.2 Related Sections

- .1 Divisions 22-23 and 26-28: Floor access covers.

### 1.3 References

- .1 American Society for Testing and Materials (ASTM)
  - .1 ASTM F 1066- 95a, Specification for Vinyl Composition Floor tile.
- .2 Canadian General Standards Board (CGSB)
  - .1 CAN/CGSB-25.20- 95, Surface Sealer for Floors.

### 1.4 Samples

- .1 Submit samples in accordance with Section 01 33 00 - Submittal Procedures.
- .2 Submit duplicate tile in size specified, 300mm long base, nosing, treads, edge strips.

### 1.5 Closeout Submittals

- .1 Provide maintenance data for resilient flooring for incorporation into manual specified in Section 01 78 00 - Closeout Submittals.

### 1.6 Environmental Requirements

- .1 Maintain air temperature and structural base temperature at flooring installation area above 20°C for 48 hours before, during and for 48 hours after installation.

### 1.7 Extra Materials

- .1 Provide maintenance materials of resilient tile flooring, base and adhesive in accordance with Section 01 78 00 - Closeout Submittals.
- .2 Provide 2% of each colour, pattern and type flooring material required for this project for maintenance use.
- .3 Extra materials to be from same production run as installed materials.
- .4 Clearly identify each container of floor tile and each container of adhesive.
- .5 Deliver to site, upon completion of the work of this section.
- .6 Store where directed by Consultant.

## **PART 2 - PRODUCTS**

### 2.1 Materials

- .1 Resilient Sheet Flooring (RSF): to ASTM F 1913, 2000mm wide x 25000mm long roll, 2mm thickness homogenous sheet vinyl flooring, in standard colour selected by Consultant.
  - .1 IQ OPTIMA as manufactured by Tarkett.
  - .2 SPHERA ELEMENT, as manufactured by Forbo.
  - .3 MIPOLAM AFFINITY, as manufactured by Gerflor.
  - .4 PALETTONE, as manufactured by Polyflor.

- .2 Resilient base (RB): to CAN4.102.2-M83, toeless rubber, minimum 1200mm length and 100mm high x 3.175mm thick, including premoulded end stops and external corners, of standard colour selected by Consultant.
  - .1 Acceptable Material: Roppe Pinnacle/ Pinnacle Plus, Johnsonite Dura Cove/ Tight Lock.
- .3 Primers and adhesives: waterproof, recommended by flooring manufacturer for specific material on applicable substrate, above, at or below grade.
- .4 Sub-floor filler and leveller: white premix latex requiring water only to produce cementitious paste as recommended by flooring manufacturer for use with their product.
- .5 Metal edge strips: aluminum extruded, smooth, polished with lip to extend under floor finish, shoulder flush with top of adjacent floor finish.
- .6 Reducer strips: wheelchair accessible rubber reducer strips by Johnsonite. Colour to be selected.
- .7 Sealer: type as recommended by flooring manufacturer.
- .8 Wax: type as recommended by flooring manufacturer.

### **PART 3 - EXECUTION**

#### 3.1 Inspection

- .1 Ensure concrete floors are dry, by using test methods recommended by tile manufacturer.

#### 3.2 Sub-floor Treatment

- .1 Remove sub-floor ridges and bumps. Fill low spots, cracks, joints, holes and other defects with sub-floor filler.
- .2 Clean floor and apply filler; trowel and float to leave smooth, flat hard surface. Prohibit traffic until filler cured and dry.
- .3 Prime concrete to flooring manufacturer's printed instructions.

#### 3.3 Application: Sheet Flooring

- .1 Provide a high ventilation rate, with maximum outside air, during installation, and for 48 to 72 hours after installation. If possible, vent directly to the outside. Do not let contaminated air recirculate through a district or whole building air distribution system. Maintain extra ventilation for at least one month following building occupation.
- .2 Apply adhesive uniformly using recommended trowel. Do not spread more adhesive than can be covered by flooring before initial set takes place.
- .3 Lay flooring to produce a minimum number of seams. Border widths to be minimum 1/3 width of full material.
- .4 Run sheets in direction of traffic. Double cut sheet joints and heat weld joints according to manufacturer's written instructions.
- .5 As installation progresses, and after installation roll flooring with 45kg minimum roller to ensure full adhesion.
- .6 Cut flooring neatly around fixed objects.
- .7 Install flooring in pan type floor access covers. Maintain floor pattern.
- .8 Continue flooring over areas which will be under built-in furniture.
- .9 Terminate flooring at centreline of door in openings where adjacent floor finish or colour is dissimilar.
- .10 Refer to Drawings for patterns/ insets. Patterns may include up to four different colours.
- .11 Install metal edge strips at unprotected or exposed edges where flooring terminates.

3.4 Base Application

- .1 Lay out base to keep number of joints at minimum. Base joints at maximum length available or at internal or premoulded corners.
- .2 Clean substrate and prime with one coat of adhesive.
- .3 Apply adhesive to back of base.
- .4 Set base against wall and floor surfaces tightly by using 3 kg hand roller.
- .5 Install straight and level to variation of 1:1000.
- .6 Scribe and fit to door frames and other obstructions.
- .7 Cope internal corners. Use premoulded corner units for right angle external corners. Use formed straight base material for external corners of other angles, minimum 300 mm each leg.

3.5 Initial Cleaning and Waxing

- .1 Remove excess adhesive from floor, base and wall surfaces with products and procedures recommended by manufacturer, without damage.
- .2 Clean, seal and wax floor and base surface to flooring manufacturer's instructions.

3.6 Protection of Finished Work

- .1 Protect new floors from time of final set of adhesive to after initial waxing until final waxing to final inspection.
- .2 Prohibit traffic on floor for 48 hours after installation.

END OF SECTION

---

**PART 1 - GENERAL**

1.1 General

- .1 Conform to Division 01 – General Requirements.

1.2 Related Sections

- .1 Section 06 40 00 – Architectural Woodwork.
- .2 Section 09 21 16 – Gypsum Board Assemblies.
- .3 Divisions 21-23/ 26-28: Mechanical and Electrical.

1.3 References

- .1 American Society for Testing and Materials (ASTM)
  - .1 ASTM D 3960 – 05(2013), Practice for Determining Volatile Organic Compound (VOC) Content of Paints and Related Coatings.
  - .2 Canadian General Standards Board (CGSB)
    - .1 CAN/CGSB-1.36-97, General Purpose Interior Varnish.
    - .2 CAN/CGSB-1.38-2000, Interior Enamel Undercoater.
    - .3 CAN/CGSB-1.100-99, Interior Latex Type, Flat Paint.
    - .4 CAN/CGSB-1.119-2000, Primer-Sealer, Wall, Interior Latex Type.
    - .5 CAN/CGSB-1.145-97, Solvent-Based Pigmented Stain.
    - .6 CAN/CGSB-1.146-99, Cold Curing, Gloss Epoxy Coating.
    - .7 CAN/CGSB-1.150-M91, Clear Lacquer for Wood Furniture.
    - .8 CAN/CGSB-1.165-2004, Cold Curing Epoxy Primer.
    - .9 CAN/CGSB-1.188-2004, Emulsion Type Filler Masonry Block.
    - .10 CAN/CGSB-1.195-99, Interior Semigloss Latex Paint.
    - .11 CAN/CGSB-1.198-2001, Cementitious Primer (for Galvanized Surfaces).
    - .12 CAN/CGSB-1.209-2003, Low Sheen Latex Interior Paint.
    - .13 CAN/CGSB-85.10-99, Shop Painting Structural Steel.
  - .3 Master Painters Institute (MPI).
    - .1 Architectural Painting Specification Manual.
  - .4 Canadian Standards Association (CSA)
    - .1 CSA Z760-94 (R2001), Life Cycle Assessment.
  - .5 Society for protective Coatings (SSPC).
    - .1 SSPC Painting Manual.

1.4 Description

- .1 Read carefully all other Sections of the Specifications to determine the extent of prime and finish coats applied by other Sections.
- .2 See Mechanical Divisions 21-23 and Electrical Division 26-28 for instructions on painting work to be done by Section 09 91 10 on surface provided by those Divisions.
- .3 Gloss range: paint and varnish textures are specified by their gloss type, which is defined by the dried film sheen factor. Refer to:
  - .1 MPI Painting Specification Manual - GLOSSARY OF TERMS to determine Sheen Factor for various gloss types.
  - .2 Locations A: Vest./ Corridors/ Stairs/ Washrooms/ Custodial/ Storage Areas
    - (1) block - MPI Gloss Level 7 (high gloss)
    - (2) gypsum board - MPI Gloss Level 3 (eggshell)
    - (3) doors/ frames - MPI Gloss Level 5 (semi gloss)
    - (4) wood - MPI Gloss level 5 (semi gloss)

- .3 Locations B: Remaining Areas
  - (1) block - MPI Gloss Level 5 (semi gloss)
  - (2) gypsum board - MPI Gloss Level 3 (eggshell)
  - (3) doors/ frames - MPI Gloss Level 5 (semi gloss)
  - (4) wood - MPI Gloss level 5 (semi gloss)

#### 1.5 Product Data

- .1 Submit product data in accordance with Section 01 33 00 – Submittal Procedures.
- .2 Submit full records of all products used. List each product in relation to finish formula and include the following:
  - .1 Finish formula designation.
  - .2 Product type and use.
  - .3 CGSB number.
  - .4 Manufacturer's product number.
  - .5 Colour numbers.
  - .6 Manufacturer's Material Safety Data Sheets (MSDS).
  - .7 Maximum VOC classification.
- .3 Submit manufacturer's application instructions for each product specified.

#### 1.6 Samples

- .1 Submit samples in accordance with Section 01 33 00 - Submittal Procedures.
- .2 Submit duplicate 300mm x 200mm sample panels of each paint, stain, clear coating, formula, type, colour, and texture specified.
- .3 Submit full range of available colours where colour availability is restricted.
- .4 Use 3mm plate steel for finishes over metal surfaces. Use 12.5mm maple plywood for finishes over wood surfaces. Use 12.5mm gypsum board for finishes over gypsum board and other smooth surfaces.

#### 1.7 Quality Assurance

- .1 Retain purchase orders, invoices and other documents to prove that all materials utilized in this contract meet requirements of the specifications. Produce documents when requested by Consultant.
- .2 Standard of Acceptance:
  - .1 Walls: No defects visible from a distance of 1000mm at 90° to surface.
  - .2 Ceilings: No defects visible from floor at 45° to surface when viewed using final lighting source.
  - .3 Final coat to exhibit uniformity of colour and uniformity of sheen across full surface area.

#### 1.8 Delivery, Storage and Handling

- .1 Deliver, store, handle and protect materials in accordance with Section 01 61 00 – Basic Product Requirements.
- .2 Deliver and store materials in original containers, sealed, with labels intact.
- .3 Indicate on containers or wrappings:
  - .1 Manufacturer's name and address.
  - .2 Type of paint.
  - .3 Compliance with applicable standard.
  - .4 Colour number in accordance with established colour schedule.
- .4 Remove damaged, opened and rejected materials from site.
- .5 Provide and maintain dry, temperature controlled, secure storage.
- .6 Observe manufacturer's recommendations for storage and handling.
- .7 Store materials and supplies away from heat generating devices.
- .8 Store materials and equipment in a well ventilated area with temperature range 7 - 30°C.

- .9 Store temperature sensitive products above minimum temperature as recommended by manufacturer.
- .10 Keep areas used for storage, cleaning and preparation, clean and orderly to approval of Consultant. After completion of operations, return areas to clean condition to approval of Consultant.
- .11 Remove only in quantities required for same day use.
- .12 Fire Safety Requirements:
  - .1 Store oily rags, waste products, empty containers and materials subject to spontaneous combustion in ULC approved, sealed containers and remove from site on a daily basis.
  - .2 Handle, store, use and dispose of flammable and combustible materials in accordance with the National Fire Code of Canada.

#### 1.9 Environmental Requirements

- .1 Safety: comply with requirements of Workplace Hazardous Materials Information System (WHMIS) regarding use, handling storage, and disposal of hazardous materials.
- .2 Apply paint finishes only when temperature at location of installation can be satisfactorily maintained within manufacturer's recommendations.
- .3 Substrate and ambient temperature must be within limits prescribed in paint standard and by manufacturer to approval of Consultant.
- .4 Maintain minimum substrate and ambient air temperature of 7°C for latex paints. Maximum relative humidity 85%. Maintain supplemental heating until paint has cured sufficiently.
- .5 Provide temporary heating where permanent facilities are not available to maintain minimum recommended temperatures.
- .6 Apply paint finish only in areas where dust is no longer being generated by related construction operations such that airborne particles will not affect the quality of the finished surface.
- .7 Apply paint only when surface to be painted is dry, properly cured and adequately prepared.
- .8 Provide minimum 270 lx on surfaces to be painted.

#### 1.10 Extra Materials

- .1 Submit maintenance materials in accordance with Section 01 78 00 – Closeout Submittals.
- .2 Submit one - four litre can of each type and colour of finish coating. Identify colour and paint type in relation to established colour schedule and finish formula.
- .3 Deliver to Site and store where directed.

## **PART 2 - PRODUCTS**

### 2.1 Paint Materials

- .1 Qualified products: only paint materials listed on the MPI Qualified Products List are acceptable for use on this project.
- .2 Qualified products: only varnish, stain, enamel, lacquer and filler materials listed on the MPI Approved Product Lists are acceptable for use on this project producing a flame spread rating of less 150.
- .3 Paint materials for each coating formula to be products of a single manufacturer.
- .4 Low odour products: Whenever possible, select products exhibiting low odour characteristics.



## 2.2 Paint Colours

- .1 Colours will be selected by Consultant. Note: There will be up to 6 different colours used.
- .2 Perform **all** colour tinting operations prior to delivery of paint to site.
- .3 Second coat in a three coat system to be tinted slightly lighter colour than top coat to show visible difference between coats.

## 2.3 Paint Finishes - INTERIOR

- .1 Concrete and Lightweight Block - Locations A – INT 4.2J Epoxy – Modified Latex, Interior, MPI Gloss Level 5 (semi-gloss)
  - .1 Two coats MPI #4; spray applied and back rolled to fill **all** pin holes, and as required by block texture.
  - .2 Two coats MPI #215; approved Devoe Coatings Tru-Glaze WB 4426 waterborne.
- .2 Concrete and Lightweight Block - Locations B – INT 4.2D Latex, Interior, High Performance Architectural, MPI Gloss Level 5 (semi-gloss)
  - .1 Two coats MPI #4; spray applied and back rolled to fill **all** pin holes, and as required by block texture.
  - .2 Two coats MPI #153; Interior, Acrylic #13210.
- .3 Gypsum Drywall – walls below 2400mm above finish floor – INT 9.2B Latex, Interior, High Performance Architectural, MPI Gloss Level 3 (eggshell)
  - .1 One coat MPI #50; Interior, Latex #59113
  - .2 Two coats MPI #153; Interior, Acrylic #13210.
- .4 Gypsum Drywall – walls above 2400mm above finish floor/ bulkheads/ ceilings – INT 9.2M Latex, Interior, Institutional, Low Odour/ VOC, MPI Gloss Level 1 (flat)
  - .1 One coat MPI #149; Interior, Latex #59113
  - .2 Two coats MPI #143; Interior, Acrylic #59111.
- .5 Metal (Ferrous) – INT5.1B – Light Industrial Coating, Interior, Water Based, MPI Gloss Level 5 (semi gloss)
  - .1 One coat MPI #79; approved Devoe Devflex 4020 DTM
  - .2 Two coats MPI #153; approved – Interior, Acrylic #13210
- .6 Metal (Ferrous) – steel stair pans and stringers, both sides – INT5.1W – Alkyd, MPI Gloss Level 7 (gloss)
  - .1 One coat MPI #107; approved Devoe Devguard #4630 Low VOC, Alkyd
  - .2 Two coats MPI #48; approved Devoe Devguard 4308H Alkyd Industrial Enamel
- .7 Wood – exposed and concealed surfaces, clear finish (CF) INT 6.3K – Varnish, Water Based, MPI Gloss Level 7 (gloss)
  - .1 Three coats MPI #56; approved Water-Based Polyurethane Clear Varnish #17003
- .8 Exposed Insulated Pipes and Ductwork – INT 10.1A – Latex, Interior, Institutional, Low Odour/ VOC, MPI Gloss Level 1 (flat)
  - .1 One coat MPI #149; Interior, Latex #59113
  - .2 Two coats MPI # 143; Interior Acrylic #59111
- .9 Interior Copper and Aluminum (Mill Finish) – INT 5.4M - Latex, Interior, High Performance Architectural, MPI Gloss Level 5 (semi gloss)
  - .1 One coat MPI #95; approved Devoe Devguard #4630, Low VOC
  - .2 Two coats MPI #153; approved DULUX Diamond, Interior, Acrylic #13210
- .10 High Temperature Pipe and Fittings – INT 5.2 - Heat Resistant Enamel, 205°C (400°F)
  - .1 Two coats MPI #21; approved Devoe HT-4H High Temperature Silicone Acrylic.

---

### **PART 3 - EXECUTION**

#### 3.1 General

- .1 Perform all painting operations in accordance with CAN/CGSB-85.100 except where specified otherwise.
- .2 Perform all painting operations in accordance with MPI Painting Specifications Manual except where specified otherwise.
- .3 Apply all paint materials in accordance with paint manufacturer's written application instructions.

#### 3.2 Preparation

- .1 Remove electrical cover plates, light fixtures, surface hardware on doors, door stops, bath accessories and all other surface mounted fittings and fastenings prior to undertaking any painting operations. Store for re-installation after painting is completed.
- .2 Move and cover furniture and portable equipment as necessary to carry out painting operations. Replace as painting operations progress.
- .3 As painting operations progress, place "WET PAINT" signs in occupied areas to approval of Consultant.

#### 3.3 Protection

- .1 Protect existing building surfaces not to be painted from paint spatters, markings and other damage. If damaged, clean and restore such surfaces as directed by Consultant.
- .2 Cover or mask floors, windows and other ornamental hardware adjacent to areas being painted to prevent damage and to protect from paint drops and splatters. Use non-staining coverings.
- .3 Protect items that are permanently attached such as Fire Labels on doors and frames.
- .4 Protect factory finished products and equipment.
- .5 Protect passing pedestrians, building occupants and the general public in and about the building.

#### 3.4 Conditions of Work

- .1 Investigate existing substrates for problems related to proper and complete preparation of surfaces to be painted. Report all damage, defects, unsatisfactory or unfavourable conditions before proceeding with work.
- .2 Investigate moisture content of surfaces to be painted and report findings. Do not proceed with work until conditions fall within acceptable range as recommended by manufacturer.
- .3 Maximum moisture content as follows:
  - .1 Plaster and wallboard: 12%.
  - .2 Masonry/Concrete: 12%.
  - .3 Concrete Block/Brick: 12%.
  - .4 Wood: 15%.

#### 3.5 Cleaning

- .1 Clean all surfaces to be painted as follows:
  - .1 Remove all dust, dirt, and other surface debris by vacuuming, wiping with dry, clean cloths or compressed air.
  - .2 Wash surfaces with solution of T.S.P. and clean warm water using a stiff bristle brush to remove dirt, oil and other surface contaminants.
  - .3 Rinse scrubbed surfaces with clean water until foreign matter is flushed from surface.
  - .4 Allow surfaces to drain completely and allow to dry thoroughly.
  - .5 To prepare surfaces for water-based painting, water-based cleaners should be used in place of organic solvents.

- .6 Use trigger operated spray nozzles for water hoses.
- .7 Many water-based paints cannot be removed with water once dried. However, minimize the use of kerosene or any such organic solvents to clean up water-based paints.
- .2 Prevent contamination of cleaned surfaces by salts, acids, alkalis, other corrosive chemicals, grease, oil and solvents before prime coat is applied and between applications of remaining coats. Apply primer, paint, or pre-treatment as soon as possible after cleaning and before deterioration occurs.
- .3 Sand existing surfaces with intact, smooth, high gloss coatings to provide adequate adhesion for new finishes.

### 3.6 Surface Preparation

- .1 Prepare new wood surfaces to CGSB 85-GP-1M.
- .2 Where possible, prime all surfaces of new wood surfaces before installation. Use same primers as specified for exposed surfaces.
- .3 Prepare previously painted wood surfaces to CGSB 85-GP-2M.
  - .1 Apply vinyl sealer to CAN/CGSB-1.126 over knots, pitch, sap and resinous areas.
  - .2 Apply wood filler to nail holes and cracks.
  - .3 Tint filler to match stains for stained woodwork.
- .4 Prepare stucco, brick, concrete masonry and concrete surfaces to CGSB 85-GP-31M.
- .5 Prepare concrete floors to CGSB 85-GP-32M. Prepare new concrete floor by acid etching. Rinse with clean water and thoroughly dry.
- .6 Prepare plaster and wallboard surfaces to CGSB 85-GP-33M.

### 3.7 Surface Preparation - Metal

- .1 Clean new metal surfaces to be painted by: removing rust, loose mill scale, welding slag, dirt, oil, grease and other foreign substances in accordance with the following:
  - .1 Solvent cleaning: SSPC-SP-1.
  - .2 Hand tool cleaning: SSPC-SP-2.
  - .3 Power tool cleaning: SSPC-SP-3.
  - .4 Commercial blast cleaning: SSPC-SP-6.
  - .5 Brush-off blast cleaning: SSPC-SP-7.
- .2 Touch up shop primer to CGSB 85-GP-10M with primer as specified in applicable section. Touch-up to include cleaning and painting of field connections, welds, rivets, nuts, washers, bolts, and damaged or defective paint and rusted areas.
- .3 Prepare galvanized steel and zinc coated steel surfaces to CGSB 85-GP-16M.
- .4 Prepare copper and copper alloys surfaces to CGSB 85-GP-20M.
- .5 Prepare new steel surfaces exposed normally to dry conditions to CGSB 85-GP-14M.
- .6 Prepare previously painted steel surfaces exposed normally to dry conditions to CGSB 85-GP-15M.
- .7 Prepare steel surfaces exposed to industrial environments to CGSB 85-GP-13M.
- .8 Prepare steel surfaces exposed to water or high humidity levels to CGSB 85-GP-11M  
CGSB 85-GP-18M.
- .9 Ductwork:  
Wash thoroughly all ductwork to be exposed and painted in completed work with mineral spirits and wipe dry with completely clean cloths. Phosphatize galvanized metal surfaces using CGSB-31-GP-116 pretreatment or prime with galvanized metal primer.
- .10 Do not apply paint until prepared surfaces have been accepted by Consultant.

### 3.8 Mixing Paint

- .1 Mix ingredients in container before and during use and ensure breaking up of lumps, complete dispersion of settled pigment, and uniform composition.

- .2 Thin paint for spraying according to manufacturer's instructions. If directions are not on container, obtain instructions in writing from manufacturer and provide copy of instructions to Consultant.
- .3 Do not use kerosene or any such organic solvents to thin water-based paints.

### 3.9 Application

- .1 Method of application to be as approved by Consultant. Apply paint by brushroller except where spraying is necessary to achieve acceptable finish. Conform to paint manufacturer's application instructions unless specified otherwise.
- .2 Brush/ roller application.
  - .1 Work paint into cracks, crevices and corners. Paint surfaces not accessible to brushes by spray, daubers or sheepskins.
  - .2 Brush out runs and sags.
  - .3 Remove runs, sags and brush marks from finished work and repaint.
- .3 Spray application.
  - .1 Provide 6mil poly dust curtains around rooms being sprayed to prevent transfer of paint and odour to other rooms.
  - .2 Provide and maintain equipment that is suitable for intended purpose, capable of properly atomizing paint to be applied, and equipped with suitable pressure regulators and gauges.
  - .3 Keep paint ingredients properly mixed in containers during paint application either by continuous mechanical agitation or by intermittent agitation as frequently as necessary.
  - .4 Apply paint in a uniform layer, with overlapping at edges of spray pattern.
  - .5 Brush out immediately all runs and sags.
  - .6 Use brushes to work paint into cracks, crevices and places which are not adequately painted by spray.
- .4 Use dipping, sheepskins or daubers only when no other method is practical in places of difficult access and only when specifically authorized by Consultant.
- .5 Apply each coat of paint as a continuous film of uniform thickness. Repaint thin spots or bare areas before next coat of paint is applied.
- .6 Allow surfaces to dry and properly cure after cleaning and between subsequent coats for minimum time period as recommended by manufacturer.
- .7 Sand and dust between each coat to remove visible defects.
- .8 Finish tops of cupboards, cabinets and projecting ledges, both above and below sight lines as specified for surrounding surfaces.
- .9 Finish inside of cupboards and cabinets as specified for outside surfaces.
- .10 Finish closets and alcoves as specified for adjoining rooms.
- .11 Finish top, bottom, edges and cutouts of doors after fitting as specified for door surfaces.
- .12 Apply final coat of paint after inspection and correction of deficiencies and installation of flooring have been completed.

### 3.10 Mechanical and Electrical Equipment

- .1 In finished areas: paint exposed conduits, piping, hangers, ductwork and other mechanical and electrical equipment. Colour and texture to match adjacent surfaces, except as noted otherwise.
- .2 In boiler room, mechanical and electrical rooms: paint exposed conduits, piping, hangers, ductwork and other mechanical and electrical equipment.
- .3 In other unfinished areas: leave exposed conduits, piping, hangers, ductwork and other mechanical and electrical equipment in original finish and touch up scratches and marks.
- .4 Touch up scratches and marks on factory painted finishes and equipment with paint as supplied by manufacturer of equipment.
- .5 Do not paint over nameplates.
- .6 Keep sprinkler heads free of paint.
- .7 Paint inside of ductwork where visible behind grilles, registers and diffusers with primer and one coat of matt black paint.

- .8 Paint disconnect switches for fire alarm system and exit light systems in red enamel.
- .9 Paint all fire protection piping red, unless directed otherwise.
- .10 Paint all natural gas piping yellow, unless directed otherwise.
- .11 Paint both sides and edges of backboards for telephone and electrical equipment before installation. Leave equipment in original finish except for touch-up as required, and paint conduits, mounting accessories and other unfinished items.

3.11 Field Quality Control

- .1 Field inspection of painting operations to be carried out by independent inspection firm as designated by Consultant.
- .2 Advise Consultant when each applied coating is ready for inspection. Do not proceed with subsequent coats until previous coat has been approved.
- .3 Co-operate with inspection firm and provide access to all areas of the work.

3.12 Restoration

- .1 Clean and re-install all hardware items that were removed before undertaken painting operations.
- .2 Remove protective coverings and warning signs as soon as practical after operations cease.
- .3 Remove paint splashings on exposed surfaces that were not painted. Remove smears and spatter immediately as operations progress, using compatible solvent.
- .4 Protect freshly completed surfaces from paint droppings and dust to approval of Consultant. Avoid scuffing newly applied paint.
- .5 Restore areas used for storage, cleaning, mixing and handling of paint to clean condition as approved by Consultant.

END OF SECTION

---

**PART 1 - GENERAL**

1.1 General

- .1 Confirm to Division 01 – General Requirements.

1.2 Shop Drawings

- .1 Submit shop drawings in accordance with Section 01 33 00.
- .2 Indicate location, type, size, panel arrangement, backing, hardware, anchor or mounting details, frame or trim and accessories.

1.3 Maintenance Data

- .1 Provide maintenance data for chalkboards for incorporation into Operating and Maintenance manual specified in Section 01 33 00.

**PART 2 - PRODUCTS**

2.1 Basic Materials

- .1 Galvanized steel sheet: Commercial grade to ASTM A526-80, with Z275 designation zinc coating.
- .2 Laminating adhesive: To manufacturer's standard.
- .3 Joint reinforcements: Concealed mechanical jointing system to provide straight, rigid, continuously supported, tight butt, flush joints at surface.
- .4 Mounting adhesive: Panel adhesive to manufacturer's standard.
- .5 Anchor clips, brackets and fasteners: concealed type recommended by manufacturer for fixed mounting.

2.2 White Boards

- .1 Facing: to comply with Porcelain Enamel Institute Standards PEI S104 regards durability, smoothness of texture, colour continuity, gloss factor of 6-8 as measured by 45° glossometer, minimum 0.076mm (.003") porcelain enamel coating fused to 0.76mm (0.03"/22 gauge) steel base sheet.
- .2 Writing surfaces:
  - .1 white; colour white.
- .3 Core: fibreboard to CSA A247-M1978, 11mm (0.44") thick, impregnated.
- .4 Back sheet: 0.46mm (26 gauge) stretcher-leveled zinc coated steel.

2.3 Tack Board

- .1 Facings: natural cork tack boards; single later cork sheet, 6mm (0.25") thick, natural colour.
- .2 Back sheet: particle board to CAN30188.1-M78, Grade R.

2.4 Fabrication

- .1 Fabricate board panels to sizes indicated.
- .2 Factory laminate boards to provide 12.7mm (0.5") total thickness.
- .3 Make finished panels flat and rigid and fit with joint reinforcement.

- .4 Furr joints between abutting board panels with joint reinforcement except where covering trim is required.

## 2.5 Trim and Framing

- .1 Trim and framing to be ASI Visual Display Products Series 9100, square corner; Cveti Products Inc. Style 200; Claridge Specialties Series 100, and as per the following specifications.
- .2 Extruded aluminum: Aluminum Association alloy AA6063-T5. Minimum 1.5mm (0.06") thickness; clear anodized finish.
- .3 Map rail: 50mm display rail, natural cork insert; continuous at heads of white boards.

## **PART 3 – EXECUTION**

### 3.1 Installation

- .1 Install white/ tack boards in accordance with manufacturer's instructions, to provide rigid secure surface.
- .2 Exact mounting height to be determined on site by Owner.
- .3 Install trim and framing around tack board panels. Make mitres and intersecting joints to hair-line fit, free of rough edges. Use concealed brackets to reinforce and hold joints tight and flush. No exposed fasteners permitted. Overlap trim 6mm (0.25") minimum into panels.
- .4 Mechanical attachment:
  - .1 to concrete or solid masonry use lag screw and expansion bolts or screws and fibre plugs as appropriate for stresses involved
  - .2 to hollow masonry use toggle bolts or equivalent
  - .3 to wood or sheet metal use screws
  - .4 to framing members in stud walls

### 3.2 Cleaning

- .1 Clean surfaces after installation using manufacturer's recommended cleaning procedures.

END OF SECTION

## **PART 1 - GENERAL**

### 1.1 General

- .1 Conform to Division 01 - General Requirements.

### 1.2 Related Sections

- .1 Section 06 10 10 – Rough Carpentry.
- .2 Section 09 21 16 – Gypsum Board Assemblies.

### 1.4 Shop Drawings

- .1 Submit samples in accordance with Section 01 33 00 - Submittal Procedures.
- .2 Indicate, by large scale details, all materials, finishes, dimensions, anchorage and assembly.

### 1.5 Samples

- .1 Submit samples in accordance with Section 01 33 00 – Submittal Procedures.
- .2 Submit duplicate 300mm long samples of profiles for corner guards.
- .3 Submit duplicate 300mm x 300mm samples of wall protection.

## **PART 2 - PRODUCTS**

### 2.1 Materials

- .1 Stainless Steel Corner Guards (CG): 50mm x 50mm x 1220mm; 16 gauge Type 304 stainless steel complete with bullnose radius guard; model CO-8 by Construction Specialties; adhesive mount.

## **PART 3 - EXECUTION**

### 3.1 Installation

- .1 Ensure substrate is clean and dry before application. Application of material implies acceptance of substrate.
- .2 Install units on solid backing and erect with materials and components straight, tight and in alignment.
- .3 Install with adhesive to manufacturer's instructions.

### 3.2 Locations

- .1 Locations are as indicated on Drawings.

END OF SECTION



## **1. GENERAL**

### 1.1 General Requirements

- .1 This general division, Division 20 – Mechanical, applies to the following detailed divisions:
  - a. Division 22 – Plumbing
  - b. Division 23 – Heating, Ventilating and Air Conditioning
  - c. Division 25 – Integrated Automation
- .2 Comply with the conditions of Division 0 and Division 1.
- .3 Specifications and drawings form an integral part of the contract documents. Any item omitted from one but which is mentioned or reasonably implied in the other, shall be considered as properly and sufficiently specified and shall be included as part of the work.

### 1.2 Cash Allowances

- .1 Refer to Division 1 for cash allowance details.

### 1.3 Liability and Property Insurance

- .1 Comply with the requirements of Division 0, Division 1 and Section GC 11.1 of CCDC 2 - 2020.
- .2 This successful Trade is to maintain adequate insurance as specified by the Owner's Standard Form of Contract. This insurance is to firmly protect both this Trade and the Owner from public liability claims and property damage, and all claims under the Workers' Compensation Act. Evidence of insurance coverage shall be filed and approved.
- .3 This Trade shall keep in force for the duration of the contract, Public Liability and Property Damage Insurance in an amount not less than \$2,000,000.00. Without limiting the foregoing, such insurance coverage shall include Comprehensive General Liability, Contractual Liability, Personal Injury and Contingent Liability with respect to Sub-trades. This Trade shall submit proof of such insurance in the form of an Insurance Certificate which shall contain a firm undertaking by the Insurer to give the Owner 30 days' notice prior to any cancellation or modification of such insurance.

### 1.4 Indemnification Claims

- .1 This Trade shall indemnify and save harmless the Owner and its respective officers and agents from all claims relating to labour and material furnished or supplied in executing the contract, and from and against all claims, demands, losses, costs, damages, actions, suits or proceedings by whomsoever made, brought or prosecuted in any manner based upon, arising out of, relating to, occasioned by or attributable to the activities or omissions of this Trade or those for whom this Trade is at law responsible in performing the contract.
- .2 Comply also with Section GC 12.1 of CCDC 2 - 2020.

### 1.5 Use of Electronic Files

- .1 A waiver must be executed prior to release of any electronic documentation.

- .2 Electronic documentation for release may consist of drawing files in formats such as a Portable Document File (PDF), AutoCAD (dwg), Revit (rvt). Specifications, details, schedules, legends shall generally NOT be released.
- .3 Electronic documents shall be used only for the specific use outlined in the waiver. The recipient may use this data for this purpose, at their own risk.
- .4 Copyright and ownership of the data are not transferred to the recipient, or to any other party. The design professional and/or owner retain all rights to the data.
- .5 Data delivered in electronic form may vary from those contained on paper copies of the documents. This information is not guaranteed to be accurate. The method of data transfer cannot be guaranteed to be error free, or compatible with the recipient's hardware, software, or systems. Contractors and subcontractors are not relieved of their normal responsibilities to independently check, coordinate, and verify information and dimensions, and to familiarize themselves thoroughly with the project. The documents may have been changed or amended by addendums, bulletins, RFI's, shop drawings, other documents, meetings, and understandings not represented on these files.
- .6 The electronic files shall not be used as a substitute for the contract documents. The Author offers no warranty or guarantee, express, implied, or statutory as to the accuracy, reliability, suitability, completeness or fitness of this data for a particular purpose. The company in receipt of these files agrees, to the fullest extent permitted by law, to defend, indemnify, and hold the Author, their directors, officers, partners, employees, harmless from all losses, claims, liabilities, injuries, damages, and expenses, including attorneys' fees and costs of defense, arising out of the use, misuse, misapplication, or misinterpretation of this data.
- .7 The recipient will not distribute the data to any other firm or individual, except the recipient's consultants or subcontractors.

#### 1.6 Workplace Safety and Insurance Board

- .1 This Trade shall produce a Workplace Safety and Insurance Board Certificate of Clearance Form at each monthly progress draw and prior to final payment under the contract.

#### 1.7 Schedule

- .1 Where specified in Division 0 or Division 1, all work shall be scheduled to meet the required project milestones.
- .2 All work in existing facilities shall be performed at times to suit the Owner and must not interfere in any way with the carrying on of business.
- .3 The facility will remain partially occupied throughout construction.
- .4 This Trade shall include all allowances for overtime rates in the bid price.

#### 1.8 Payment Certification

- .1 Submit a sample progress draw to the Consultant within one week of award of contract for review and approval.

- .2 Submit monthly progress draws to the Consultant for review and certification. Monthly progress draws shall resemble approved sample progress draw.

#### 1.9 Extras and Credits

- .1 All extras and credits must be submitted to and approved by the Consultant prior to such work commencing. They shall be priced individually with a complete breakdown clearly indicating all labour and material costs, overhead and profit mark-up and tax.
- .2 Labour rates for extras and credits shall be identical. They shall be valued at payroll cost plus a percentage mark-up for burden as stipulated in Division 0.
- .3 Only the net difference between an extra and a credit will be subject to overhead and profit mark-up.

#### 1.10 Scope of Work

- .1 Supply and install all equipment and materials as specified and / or shown on the drawings and required to provide complete, properly functioning, mechanical systems fit to the intended use. Provide all labour for the satisfactory completion of the work. Supply any miscellaneous equipment and materials not herein listed necessary for the proper installation and operation of the systems.
- .2 All of the equipment and materials required for the work shall be new, the best of their respective kinds and installed in a first-class manner. Similar equipment shall be of the same manufacturer unless noted otherwise.
- .3 All deposits, levies or similar fees, if any, required for completion of the mechanical work shall be paid as follows:
  - a. Fees for approval and inspection of any portion of mechanical system by any government agency, department or authority shall be included in the bid price.
  - b. Acquiring a building permit and paying all associated fees shall be by the Consultant.
- .4 Unless noted otherwise, the bid price may be based on the use of products equal to those specified herein. Where 'approved equals' are listed, only products from these manufacturers may be used in the bid price. Where approved equals are not listed, any manufacturer may be used in the bid price.
- .5 Unless specifically stated otherwise, this project has been designed based on the first named manufacturer of each section or that specifically listed in the schedules. If this Trade chooses to use a manufacturer other than the first named manufacturer, it will be their responsibility to ensure that all equal and alternative equipment meets the mechanical specification, is similar in dimensions, stability, quality, weight, ease of maintenance, performance, etc. and that the equipment will fit into the space allocated. This Trade shall be responsible for preparing revised design drawings (if directed by the Consultant) and shall carry all costs required to accommodate the equal / alternative equipment INCLUDING ALL COSTS INCURRED BY OTHER TRADES. The Consultant reserves the right to approve or reject any alternate based upon his evaluation of the equipment proposed. If only one manufacturer is listed, then only that manufacturer shall be acceptable.

- .6 'Provide' means to supply and install the products specified. The 'work' means the total construction required by the Contract Documents and includes all labour and 'products'. 'Products' means all materials and equipment forming the completed work as required by the Contract Documents.
- .7 All mechanical work shall be in accordance with the regulations of the Ontario Building Code (OBC), Canadian Gas Association (CGA), Technical Standards and Safety Authority (TSSA), Natural Gas and Propane Installation Code, National Fire Protection Association (NFPA), Canadian Standards Association (CSA), Ontario Fire Code, Ontario Electrical Safety Code (OESC), all Municipal regulations and any authorities having jurisdiction.

#### 1.11 Examination of Site and Contract Documents

- .1 It is the responsibility of this Trade to carefully review the drawings, specifications and other instructions and notify the Owner in writing of any errors, omissions and discrepancies prior to closing of tenders. This Trade shall abide by the decision given in writing. The work as shown is intended to be completed in all respects and that failure to notify the Owner of any discrepancies will not relieve this Trade of responsibility for completing the work as intended. In no case shall this Trade proceed in uncertainty.
- .2 This Trade shall visit the building and become thoroughly familiar with all the existing mechanical systems and other conditions to be met in carrying out the work covered by these specifications prior to submitting the bid price. Arrangements for a site inspection may be made as described in Division 1.
- .3 Examine all mechanical specification divisions and sections and all other related contract documents. The mechanical specification is to be read in conjunction with all other divisions and sections of the specification. In the event of conflict between documents, this specification shall govern.
- .4 Mechanical drawings are not to be scaled. Refer to architectural drawings for all dimensions.

#### 1.12 Intent

- .1 Provide all products specified or shown in the contract documents complete with incidentals necessary for a complete operating installation. Provide all tools, instruments, equipment and labour required to do the work.
- .2 The contract documents are not intended to enumerate each and every detail which may be necessary to furnish and install the complete system ready for operation. The bid price shall include all such details, and all associated labour and materials, to provide a complete and working system. The omission of any details in the contract documents shall not be a warrant for poor workmanship or the omission of such details.
- .3 Where the drawings or specifications assign work to a particular Trade, this is intended to be used as a guide only to assist this Trade with the preparation of the bid price. The final decision as to which Trade provides required labour or materials rests solely with this Trade. Extra payments will not be considered based on a difference in interpretation of the contract documents as to which Trade involved provides labour or materials for specific items of work. The Consultant will not enter into such discussions.

- .4 Wherever differences occur in the contract documents, the maximum conditions will govern and shall be allowed for in the bid price. The items to be incorporated will be at the option of the Consultant.
- .5 All Work shall be carried out by qualified Trades and Sub-trades with established reputations for the type of work involved and performed to good industry standards.

### 1.13 Shop Drawings

- .1 Shop drawings shall be submitted as PDF files via email. All shop drawings shall bear a signed and dated stamp indicating this Trade has reviewed and approved the submission.
- .2 Shop drawings shall be submitted for all products (including all associated accessories, controls, etc.), including but not limited to:
  - a. Water treatment including cleaning / treatment chemicals and dosage rates.
  - b. Fan coils.
  - c. Unit heaters.
  - d. Grilles / diffusers.
  - e. Dampers.
  - f. Louvres.
  - g. Fire dampers.
  - h. Combination fire and smoke dampers.
  - i. Access doors.
  - j. Relief caps.
  - k. Fans.
  - l. Rooftop units.
  - m. Condensing units.
  - n. VVT systems.
  - o. Pressure regulating / relief valves.
  - p. Welding booth hoods.
  - q. Building automation system including all components, wiring diagrams, sequences and points lists.
  - r. Miscellaneous controls and accessories for all of the above.
  - s. Firestopping systems.
- .3 For firestopping systems, shop drawings shall show construction conditions, relationships to adjoining construction, dimensions, description of materials and finishes, component connections, anchorage methods, hardware and installation procedures, plus the following:
  - a. Firestop design designation of testing and inspecting agency acceptable to the authorities having jurisdiction.
  - b. Documentation, including illustrations, from a qualified testing and inspection agency that is applicable to each firestop system configuration for construction and penetrating items. Factory or manufacturer furnished installation details are not acceptable in lieu of published documents by approved testing agencies.
  - c. Where conditions require modification of a qualified testing and inspecting agency's illustration to suit a particular firestop condition, submit illustration, with modifications marked, approved by the firestop system manufacturer's fire-protection Engineer.

- .4 For additional shop drawing requirements, refer to other divisions and sections of this specification.
- .5 Allow maximum two weeks for Consultant's review.

#### 1.14 Questions

- .1 Questions pertaining to the work shall be submitted to the Consultant in writing in the form of a Request for Information (RFI).
- .2 Allow for up to two weeks for RFI response from the Consultant. Claims for delay within this period will not be accepted.

#### 1.15 As-built Drawings

- .1 Obtain an extra set of prints, for the job use only, on which to generate as-built drawings including the accurate recording of all deviations from the contract drawings.
- .2 Take special care to indicate buried drains, inverts (shown at main reference points) and dimensioned distances from visible reference points such as walls or columns.
- .3 Submit to the Consultant for approval one complete set of as-built drawings (hard copy) at project completion. The approved as-built drawings shall then be submitted to the Owner in both hard copy (one copy) and electronic (scanned) format.
- .4 Prior to Substantial Performance, this Trade shall edit the electronic files to provide AutoCAD as-built drawings that incorporate all redline information. Electronic base tender plans shall be provided from the Consultant at no cost. All other associated costs shall be carried in the bid.
- .5 The Consultant shall provide, at no cost, AutoCAD drawing files incorporating Changes and Instructions.
- .6 Generation of AutoCAD as-built drawings may be arranged with the Consultant.

#### 1.16 Identification

- .1 Identification plates shall be engraved two-ply plastic, 0.125" (3 mm) thick, 1.0" (25 mm) high with 3/4" (19 mm) white characters on black background and length as required. Locate in a conspicuous location and secure with self-tapping sheet metal screws to equipment. All screws used outside shall be stainless steel. Nameplates which are not exposed to outdoor conditions may be secured with double sided adhesive tape. All starters shall be identified by the Electrical Trade.
- .2 Where noted below, identify pipe mains by means of pressure sensitive adhesive labels. Markers and flow arrows shall be in accordance with ANSI/ASME A13.1 latest edition. Identify medium by lettered legend and direction of flow by arrows. Provide labels as follows:
  - a. At intervals not greater than 50 ft (15 m), changes of direction, upstream of major manually / automatically operated control valves, at all branch pipe connections, behind all access doors and on both sides where pipes pass through walls. Use

approximate spacing intervals of 25 ft (7.6 m) for all piping running through suspended ceiling spaces.

- b. Labels shall be sized as follows (pipe diameter includes insulation where applicable):
  - i. 0.75" (19 mm) to 1.25" (32 mm) piping:
    - 1) Minimum 8" (200 mm) long label with minimum 0.5" (13 mm) letter height.
  - ii. 1.5" (38 mm) to 2" (50 mm) piping:
    - 1) Minimum 8" (200 mm) long label with minimum 0.75" (19 mm) letter height.
  - iii. 2.5" (63 mm) to 6" (150 mm) piping:
    - 1) Minimum 12" (300 mm) long label with minimum 1.25" (32 mm) letter height.
- c. All identification labels shall be easily and accurately readable from usual operating areas, plane of legend to be approximately at right angles to most convenient line of sight.
- d. Piping running exposed through rooms other than mechanical, electrical, storage and custodial rooms shall not be identified.
- e. Wording of all labels shall be approved by the Consultant prior to manufacture.
- f. Identify gas piping to Code requirements. Note that all outside piping shall be painted.

.3 Identification of equipment / systems shall be as follows:

- a. All equipment with symbols included in drawing schedules or plans shall be identified to match symbols indicated.
- b. The following items shall be tagged at installed location and keyed to a control wiring diagram. Diagram shall be included in the Operation and Maintenance Manual:
  - i. All components of building automation systems.
  - ii. All components of VVT control systems.
- c. For additional requirements regarding refrigeration system identification, refer to Division 23 - Heating, Ventilating and Air Conditioning.
- d. Provide additional miscellaneous identification labels as described on the drawings or in other divisions and sections of the specification.
- e. Identification of all equipment / systems not listed above or on the drawings is not required for this project.
- f. All equipment, valves, motorized / automatic control dampers, major components of the building automation system, miscellaneous controls / transformers, etc. located above suspended ceilings shall be identified with 0.25" (6 mm) diameter coloured markers with adhesive backing. Colour of markers shall be red.

.4 Verify all identification labels / tags on site with the Owner / Consultant prior to installation and adjust as directed.

#### 1.17 Close-out Documentation – Operation and Maintenance Manual

.1 Upon project completion, this Trade shall submit an Operation and Maintenance Manual as well as as-built drawings. Submit one paper hard copy in a three-ring binder, and one .PDF electronic copy on a suitably sized USB thumb drive. Each manual shall contain the following:

- a. Warranty.
- b. Extended warranties.

- c. Contact list (Sub-trades, suppliers, manufacturers, etc.).
  - d. Sign-back of latest Site Review Report (confirmation of completion).
  - e. Permits and approvals.
  - f. Certificates (pipe pressure test, etc.).
  - g. Test reports (water analysis/treatment, etc.).
  - h. Firestop manufacturer sign-off.
  - i. Shop drawings (revised as reviewed by the Consultant).
  - j. Equipment start-up reports (including hood smoke test, etc.).
  - k. Equipment operation and maintenance manuals.
  - l. On-site instruction documents.
  - m. TAB (air and water testing, adjusting and balancing) reports.
- .2 This Trade shall instruct the Owner on site to the full satisfaction of the Consultant on the operation and maintenance of all mechanical systems.

#### 1.18 Cutting, Patching and Refinishing

- .1 This Trade shall allow for cutting and patching of building assemblies to support own project work. Cutting and patching shall be performed by workers specialized in this type of work and capable of performing to good commercial standards. All work shall be to the approval of the Architect / General Contractor.
- .2 No cutting of the building envelope or structural elements shall be done without permission of the Architect.
- .3 This Trade shall patch new openings in building assemblies and openings caused by the removal of existing work. Patching shall be done to maintain existing fire separations, sound transmission class ratings, vapour retarder performance, insulation values, etc. Patching of exterior wall openings shall include filling voids and annular spaces with Roxul (not pink) batt insulation and providing a watertight seal on both sides.
- .4 Finishes damaged by cutting and patching by this Trade shall be made good by this Trade with materials and colours to match existing unless noted on the architectural drawings to be refinished by the General Contractor.
- .5 This Trade shall provide openings in drywall / plywood walls and ceilings.
- .6 This Trade shall provide openings in masonry walls where lintels are not required. The General Contractor shall provide openings where lintels are required.
- .7 The General Contractor shall provide structural supports or lintels for applicable openings.
- .8 The General Contractor shall provide framing for openings in floors, walls (including metal and wood studs) and roofs.
- .9 The General Contractor shall provide cutting, patching and refinishing of existing roof assembly.
- .10 Conduct a photo survey of existing conditions both inside and outside the building, including of the ceiling immediately below renovation work. Immediately notify the Architect / General Contractor if any resemblance of water leakage or damage is found.



- .11 Protect the existing roofing system from damage at all times. Provide plywood work platforms / walkways as required.
- .12 Where wall openings caused by the removal of thermostats, sensors, etc. are not covered by new wall finishes (refer to architectural drawings) or new thermostats, sensors, etc., provide stainless steel coverplates.
- .13 This Trade shall provide acoustic ceiling tiles matching existing to replace openings caused by the removal of diffusers, grilles, etc.
- .14 This Trade shall remove and reinstall existing acoustic ceiling tiles and grid, lights, etc. as required to suit own project work. Repair or replace materials damaged by this work with materials matching existing.
- .15 This Trade shall provide grid continuously around new supply air diffusers and eggcrate return air grilles installed in existing acoustic ceiling tiles. The General Contractor shall provide grid continuously around new supply air diffusers and eggcrate return air grilles installed in new acoustic ceiling tiles.

#### 1.19 Cleaning

- .1 New or affected equipment, fixtures, ductwork, piping, building finishes, building contents, etc. soiled by this Trade's work shall be cleaned to the satisfaction of the Consultant at job completion.
- .2 At the completion of each day's work and at project completion, remove from the area of work all dirt, rubbish, surplus material and equipment associated with this Trade's systems installation and not required in the finished work.
- .3 At project completion, replace all new / existing air filters which have been soiled by the work.

#### 1.20 Existing Construction

- .1 This Trade shall provide adequate protection to existing systems (all disciplines), pavement, curbs, walkways, sodding, shrubs, building construction, building contents, etc. throughout the project. This Trade shall be responsible for restoring to its original condition or replacing any removed or damaged item in connection with the work unless otherwise directed by the Consultant.
- .2 Undertake all necessary measures required by this Trade's work to maintain adequate security of the existing building at all times.
- .3 Any interruption of this Trades services to any part of the existing buildings shall come at a time agreeable to the Owner and Consultant.

#### 1.21 Protection

- .1 Where foreseeable damage of any description could result from this Trade's work, this Trade shall provide adequate protection of work previously completed, including work of others. This Trade will be responsible for restoring any damaged materials.

### 1.22 Demolition

- .1 This Trade shall be responsible for revisions to and for the complete removal of this Trade's systems to permit the new work, all as shown on the drawings or described in the specification. This includes removal of materials from the site. All disposal costs shall be included in the bid price.
- .2 Materials being removed shall become the property of the Owner unless shown otherwise, and if the Owner has no use for it, it shall be disposed of by this Trade. This Trade shall include in the bid price for the disposal of all materials. Note that the Owner shall have the first right of refusal for all demolished equipment.
- .3 Demolished materials shall not be reused unless noted otherwise.

### 1.23 Asbestos

- .1 Where asbestos will be disturbed in the execution of this contract, comply with the regulation respecting asbestos on construction projects and in buildings and repair operations made under the Occupational Health and Safety Act, Ontario Regulation 654/85 and local requirements pertaining to asbestos. Asbestos inspection reports have been bound into this specification for use by this Trade. Employ only licensed asbestos removal Trades to execute abatement of all asbestos.
- .2 Include the cost of retaining an Owner-approved Sub-trade for the abatement of all asbestos containing materials (ACM) within 24" (600mm) radius of any mechanical work. Refer to the Owner's Hazardous Materials Building Survey.

### 1.24 Sleeves

- .1 Provide sleeves for piping and ductwork as follows:
  - a. For all copper pipe penetrations of masonry and precast structures where required to prevent direct contact of the structure with the copper piping. Sleeves are not required provided that direct contact of the structure is prevented and provided the openings comply with the firestop manufacturer's requirements (where applicable).
  - b. Where required for proper installation of pipe firestop systems.
  - c. Where required for proper installation of fire and combination fire / smoke dampers.
- .2 Pipe sleeves shall be as follows (Trade to choose desired type):
  - a. Schedule 40 steel.
- .3 Ductwork sleeves shall be manufactured of galvanized sheet steel of at least the same gauge as ductwork penetrating wall.
- .4 Floor sleeves shall have a minimum 0.5" (13mm) lip on the upper side. All other sleeves shall be flush with adjacent surfaces.
- .5 Unless otherwise directed, all sleeves and openings shall provide minimum 0.25" (6 mm) clear space to ductwork, pipe or insulation. Provide space for application of firestopping for all sleeves and openings according to the fire stop manufacturer's detailed installation drawings.

For sleeves used with fire and combination fire / smoke dampers, comply also with the manufacturer's requirements.

- .6 Provide waterproof, fire retardant, non-hardening caulking between sleeves and building construction where required for a weathertight installation.

### 1.25 Firestopping

- .1 Firestopping shall be 3M or approved equal fire stop sealant / devices, listed in the UL fire Resistance Directory under categories XHCR (firestop devices) and XHEZ (firestop systems) and of a type to suit construction type, penetrant type, annular space requirements and fire rating involved in each separate instance. Systems shall be symmetrical for wall applications and shall be asbestos free. Install according to manufacturer's detailed installation instructions.
- .2 All firestop materials shall be of the same manufacturer as that used by the General Contractor. Co-ordinate on site.
- .3 Firestop systems shall comply with the required F, T and L ratings, as determined per ASTM E814 / ASTM E119 (as applicable). F ratings shall meet or exceed the fire-resistance ratings of the construction assembly. Firestop systems shall have the required flame spread and smoke developed ratings to suit the point of application and to comply with Code requirements.
- .4 Provide components that are needed for fill materials and to comply with the manufacturer's detailed installation instructions. Use components specified by the manufacturer and approved by the qualified testing and inspection agency, including slag / rock-wool-fiber insulation, forming / damming / backing materials, fillers for sealants, substrate primers, collars / steel sleeves, etc.
- .5 For firestop systems exposed to view, traffic, moisture and physical damage, provide products that after curing do not deteriorate when exposed to these conditions.
- .6 Firestop systems shall be installed by an experienced installer who
  - a. Is qualified by having the necessary experience, staff and training to install the manufacturer's products.
  - b. Is acceptable to or licensed by the manufacturer or local authority.
  - c. Has established a record of successful in-service experience with firestop systems or completed a manufacturer's certified product installation training course.
- .7 Deliver firestop system products to site in original, unopened containers or packages with intact and legible manufacturer's labels identifying product and manufacturer, date of manufacture, lot number, shelf life, qualified testing and inspection agency's classification marking, curing time and mixing instructions. Store and handle materials to prevent their deterioration or damage due to moisture, temperature changes, contaminants or other causes. Follow manufacturer's instructions.
- .8 Verify the condition of the substrates and correct unsatisfactory conditions before installing firestop system products. Follow manufacturer's detailed installation instructions and comply with requirements for temperature and humidity conditions. Coordinate construction and sizing of sleeves, openings and penetrating items to ensure compliance with installation instructions.

- .9 Upon project completion, the firestop manufacturer shall provide a letter certifying that all fire stop systems throughout the project have been installed according to their detailed installation instructions and Code requirements.

#### 1.26 Sound Packing

- .1 Where pipes and ductwork pass through non-rated walls, pack around ductwork or pipe with mineral wool filler to reduce noise transmission.

#### 1.27 Cements and Primers

- .1 All cements, primers, etc. shall be low volatile organic compound type, tested to meet the requirements of SCAQMD rule 1168, Test Method #316A (South Coast Air Quality Management District).

#### 1.28 Access Doors for Walls and Ceilings

- .1 Provide to the General Contractor for installation access doors for concealed mechanical equipment requiring accessibility for service and maintenance. These items should be grouped wherever possible in order to reduce the number of panels required. Doors shall be 12"x12" (300x300 mm) for hand access, 18"x18" (450x450 mm) for arm access, 24"x18" (600x450 mm) for head and shoulders access and 24"x24" (600x600 mm) for torso access unless noted otherwise on plans. Doors shall be complete with positive locking self-opening screwdriver lock. The exact size of access doors shall be as recommended by the manufacturer to suit the application.
- .2 Doors shall be manufactured by Acudor or approved equal and shall be of the following types (Trade to choose applicable type):
  - a. Drywall / Block Walls or Ceilings: Model UF-5000 having the following features:
    - i. Uninsulated steel construction.
    - ii. Doors up to 16"x16" (400x400 mm) shall have 16 gauge doors and 18 gauge mounting frame.
    - iii. Doors over 16"x16" (400x400 mm) shall have 14 gauge doors and 16 gauge mounting frame.
    - iv. Door shall be flush to frame with rounded safety corners.
    - v. A one-piece outer flange shall be welded to the mounting frame.
    - vi. Continuous concealed hinge.
    - vii. Stainless steel screwdriver operated cam latch.
    - viii. Prime coat of white alkyd baked enamel.
  - b. Fire Rated Drywall / Block Walls: Model FB-5050 having the following features:
    - i. Insulated steel construction.
    - ii. ULC 2.0 hour B label.
    - iii. Doors shall be 20 gauge and mounting frames shall be 16 gauge.
    - iv. Doors shall be filled with 2" (50 mm) thick fire rated insulation.
    - v. Door shall be flush to frame with reinforced edges, flange to be 1" (25 mm) wide.
    - vi. Self-closing and self-latching.
    - vii. Inside latch release.
    - viii. Concealed hinge.
    - ix. Universal self-latching bolt latch, operated by a flush key.

- x. Prime coat of white alkyd baked enamel.
- c. Fire Rated Ceilings: Model FW-5050 having the following features:
  - i. Insulated steel construction.
  - ii. Warnock Hersey International 3.0 hour B label.
  - iii. Doors shall be 20 gauge and mounting frames shall be 16 gauge.
  - iv. Doors shall be filled with 2" (50 mm) thick fire rated insulation.
  - v. Door shall be flush to frame with reinforced edges, flange to be 1" (25 mm) wide.
  - vi. Self-closing and self-latching.
  - vii. Inside latch release.
  - viii. Concealed hinge.
  - ix. Universal self-latching bolt latch, operated by a flush key.
  - x. Prime coat of white alkyd baked enamel.

#### 1.29 Dissimilar Metals

- .1 Separate dissimilar metals by means of gaskets or shims of approved material in order to prevent electrolytic action. Where piping of dissimilar metals is connected, use approved dielectric unions or flanges. A brass fitting or brass valve may also be used in making connections between copper and steel piping.
- .2 Where supporting copper pipe, isolate pipe from hanger with electrolytic action tape or equivalent or use copper / plastic coated supports. Direct contact between copper piping and concrete, masonry or precast construction will not be permitted.

#### 1.30 Installation Requirements

- .1 Install equipment and services as follows:
  - a. Neatly following building lines and in such a manner as to permit free use of space and maximum headroom.
  - b. To allow free access for maintenance, adjustment and eventual replacement.
  - c. In accordance with the manufacturer's requirements.
  - d. Provide all supports, hangers and fasteners except as otherwise noted.
  - e. Do not support piping or ductwork from equipment.
  - f. Secure all products and services so as not to impose undue stresses on the structure or systems.
  - g. Cap off and seal all open ends of new / affected ductwork, venting, piping and conduits to prevent entrance of foreign matter.
  - h. Do not install piping in a location or manner which might result in freezing.
  - i. Layout and install piping, valves, fittings, cleanouts, etc. in conveniently accessible spaces to facilitate easy maintenance.
  - j. All exposed ductwork and piping shall present a neat appearance and located parallel to and centered between building structure, lights, etc.
  - k. Support of ductwork, piping, equipment, etc. from the metal roof / floor deck will not be permitted except as otherwise noted.

#### 1.31 Packaged Equipment Installation and Start-up

- .1 Handle equipment carefully to prevent damage, breaking, denting and scoring. Damaged units or damaged components shall not be installed. Replace damaged parts with new supplied by the manufacturer.
- .2 If equipment is to be stored prior to installation, store in a clean, dry place. Protect from weather, dirt, fumes, water, physical damage, etc.
- .3 Comply with the manufacturer's rigging and installation instructions for unloading and moving into final location.
- .4 Level equipment according to manufacturer's requirements, and to permit proper condensate drainage where applicable.
- .5 Assemble, install and start-up equipment according to manufacturer's requirements. Complete all manufacturer start-up literature (where applicable) and include in the Operation and Maintenance Manual.
- .6 Provide adequate / manufacturer's required / Code required clearances to permit servicing and maintenance of equipment.

#### 1.32 Flashings

- .1 Unless noted below, all flashings and counter flashings required for this Trade's work shall be supplied and installed by the General Contractor.
- .2 If piping and wiring is not indicated on drawings to penetrate roof assembly through a doghouse, it shall penetrate through the following roof flashing system:
  - a. Portals Plus extra tall Aluma-Flash complete with 0.60" aluminum base, 13" high and 14" diameter. 8" collar opening shall have two sealing rings to suit EPDM cap of type to suit services. All services to be secured to cap with stainless steel clamps.
  - b. Roof flashing system to be supplied by this Trade and installed by the General Contractor.

#### 1.33 Work Performed by the General Contractor

- .1 The following work shall be performed by the General Contractor:
  - a. Furred in ductwork / pipe spaces.
  - b. Structural supports for equipment.
  - c. Unless noted otherwise, all painting associated with this Trade's systems installations (including ductwork) except that painting of gas piping and refinishing of surfaces damaged by this Trade's work shall be by this Trade.
  - d. Roof flashings for mechanical systems.
  - e. Work outlined in Cutting, Patching and Refinishing section.

#### 1.34 Paint

- .1 Paint for gas piping and for patching of existing / damaged finishes shall be good quality commercial grade of a type to suit the application. Apply according to manufacturer's

requirements. All painted surfaces shall have a minimum of one primer coat and two finish coats.

### 1.35 Inspection Certification and Review

- .1 Arrange for inspection of all work by the authorities having jurisdiction. Obtain unconditional certificates of approval, acceptance and compliance with rules and regulations for authorities having jurisdiction. The work will not be considered complete until such certificates have been delivered to the Owner.
- .2 Attend promptly to any deficiencies reported. Request final review when the completed installation has been checked and all deficiencies have been rectified.

### 1.36 Testing, Adjusting and Balancing

- .1 Retain the services of an independent Balancing Trade to test, adjust and balance the systems and include for the provision of a balancing report. All work shall be performed in compliance to the requirements of the National Environmental Balancing Bureau (NEBB) or Associated Air Balance Council (AABC) and the Balancing Trade shall be certified with one of these agencies.
- .2 The following is a list of the approved Balancing Trades whom may quote on the balancing of the systems:
  - a. Air Audit Inc., 110 Turnbull Court, Cambridge, Ontario, N1R 1K2, (519) 740-0871
  - b. Clark Balancing Ltd., 8094 Esquesing Line, Milton, Ontario, L9T 2X9, (905) 693-1518
  - c. Airwaso Canada Inc., 124-4096 Meadowbrook Drive, London, Ontario, N6L 1G4, (519) 652-4040
  - d. Dynamic Flow Balancing Ltd., 1200 Speers Road, Unit 36, Oakville, Ontario, L6L 2X4, (905) 338-0808
  - e. Air Velocities, 100 Premium Way, Mississauga, Ontario, L5B 1A2, (905) 279-4433
  - f. Flowset Balancing Ltd., 431 Willis Drive, Oakville, Ontario, L6L 4V6, (416) 410-9793
- .3 Provide all necessary precision instruments, pressure gauges, manometers, thermometers, etc. for measuring and adjusting. Use instruments which are of correct scale and accurately calibrated.
- .4 All balancing shall be done in a manner to minimize throttling losses and using speed adjustment to meet design flowrates. Final flowrates shall be within ten percent (10%) of specified value.
- .5 Start balancing only when the work is essentially completed, including: installation of ceilings, doors, windows and other construction affecting testing and balancing; application of sealing, caulking and weatherstripping; normal operation of mechanical / electrical / control systems affecting testing and balancing; thermal overload protection in place for electrical equipment; air filters clean and in place; ductwork systems clean of debris; correct fan rotation; fire and volume dampers in place and open; coil fins cleaned; all ductwork outlets installed and connected; access doors closed; ductwork installation complete; water systems flushed, filled and vented; correct pump rotation; proper strainer baskets clean and in place; service and balancing valves fully open; liquid treatment system operable.
- .6 The Balancing Trade shall perform the following work in regards to air systems:

- a. Test and adjust system / equipment for design air flows.
  - b. Equipment requiring air balancing shall be as follows:
    - i. All new exhaust fans.
    - ii. All new rooftop units, new fan coils and refurbished unit ventilators, including minimum outdoor air adjustment.
    - iii. Existing fan coil, including minimum outdoor air adjustment.
  - c. Locations of systems measurements / adjustments shall include but not be limited to the following as appropriate:
    - i. Each duct run-out (or grille / diffuser) having an indicated airflow on the drawings.
    - ii. Each VVT system damper (zone and by-pass).
    - iii. Make pitot tube traverse of main supply / return / exhaust duct to verify design airflows at equipment.
  - d. Measurements shall include but not be limited to the following as appropriate for systems / equipment / controls:
    - i. Air velocity, flow rate, static pressures (including suction and discharge), ductwork cross-sectional area, RPM, electrical power (including full load amperes), voltage, sheave diameter / setting, belt quantity / size.
  - e. Test and adjust blower RPM to design requirements. All required pulleys shall be supplied / installed / adjusted by the Balancing Trade.
  - f. Adjust grilles and diffusers to obtain optimum air distribution patterns. Also adjust to suit the Consultant.
  - g. Verify control system operation and report on any installation problems observed, including excessive duct pressures when VVT systems are operating in by-pass mode. Physical changes in the control system, such as relocating sensors or calibrating controllers, are the responsibility of the Mechanical Trade. The Balancing Trade shall work closely with Mechanical Trade to identify and correct problems.
  - h. For VVT systems, perform the following to ensure excessive noise is not generated:
    - i. For each VVT system, the Balancing Trade shall measure the static pressure in the main ductwork at the location of the by-pass damper using a manometer when the system is in fixed mode (all zone dampers are full open and the by-pass damper is full closed). This information shall be included in the TAB Report and shall be given to the Mechanical Trade for verification that the VVT system is properly calibrated.
    - ii. For each VVT system, 10% of the dampers shall be set to the full open position and 90% shall be set at their minimum position. When operating with these damper positions, the static pressure in the main ductwork at the location of the by-pass damper shall again be measured by the Balancing Trade using a manometer to ensure it remains at the value measured when in the fixed mode. This information shall be included in the TAB Report and shall be given to the Mechanical Trade for verification that the VVT system is operating correctly and is properly calibrated.
    - iii. During balancing procedures, set controls to a fixed mode (by-pass damper locked fully closed and all zone dampers locked fully open) to prevent any changes during the balancing procedure. In the fixed mode, only the system manual balancing dampers shall be used to achieve the indicated balancing airflows.
- .7 The Balancing Trade shall perform the following work in regards to water systems:
- a. Test and adjust system / equipment for design water flows.



- b. Equipment requiring water balancing shall be as follows:
    - i. Each wall fin heater and unit heater.
    - ii. Each heating coil (unit ventilator and fan coil).
  - c. Locations of systems measurements / adjustments shall include but not be limited to the following as appropriate:
    - i. Each circuit balancing valve.
  - d. Measurements to include but not limited to the following as appropriate for systems, equipment, components, controls:
    - i. Flow rate, head pressure / pressure drop, temperature, RPM, electrical power (including full load amperes), voltage.
  - e. Fluid flow quantities shall be measured using the installed devices provided by Others.
  - f. The Balancing Trade shall not continue the water balancing if at any time hazardous conditions are observed. These conditions shall be reported before proceeding further.
  - g. The Balancing Trade shall apply any necessary correction factors to the indicated values to account for the density of the fluid flowing in the system.
  - h. If specified, pitot tube traverse shall be taken where required on the drawings, provided valved openings are properly installed.
  - i. Position all automatic control valves and balancing / isolation for full flow through equipment during initial pump adjustment.
- .8 Upon balancing completion, the Balancing Trade shall submit the final system balancing report (TAB Report) to the Mechanical Trade for inclusion in the Operation and Maintenance Manual. One paper hard copy and one .PDF electronic copy is required. Report shall include index page, index tabs and shall be certified by the Balancing Trade. Handwritten data will not be accepted. Include types, size, manufacturer, serial numbers and dates of calibration of all instruments used. The format shall be in accordance with the Canadian AABC or NEBB Report Form and approved by the Consultant. In addition, the report shall include:
- a. Project record drawings.
  - b. System schematics.
  - c. All measured / adjusted values (include initial and final readings).
  - d. All pertinent information regarding balanced equipment shall be listed, such as:
    - i. Designation of equipment.
    - ii. Manufacturer.
    - iii. Type.
    - iv. Size.
    - v. Motor nameplate characteristics.
- .9 During the system testing, adjusting and balancing, the Mechanical Trade shall fully demonstrate the operation of all controls. The Mechanical Trade shall be present during the testing, adjusting and balancing and make modifications as often as necessary to satisfy the Balancing Trade.

### 1.37 Commissioning

- .1 At or near the completion of the project, this Trade shall provide acceptance tests to demonstrate that the equipment and systems actually meet the specified requirements. Tests may be conducted as soon as conditions permit.

- .2 Concurrently, written approvals or acceptances by local authorities shall be presented. In testing, vary loads to illustrate start-up, operating sequences, normal shut down and simulate emergency conditions. Final tests shall be conducted in the presence of the Consultant where directed.

#### 1.38 Substantial Performance Certificate

- .1 Before the Contractor can make application for a Certificate of Substantial Performance the Mechanical Trade will be required to provide the following as detailed within this section:
  - a. Maintenance and Instruction Manuals.
  - b. As-Built drawings.
  - c. Testing.
  - d. Commissioning.
  - e. Training and Demonstrations.
  - f. Warranty cards.

#### 1.39 Discount Pricing

- .1 The Waterloo Region District School Board receives discount pricing from Noble Trade. This Trade is encouraged to contact Noble Trade for pricing on this project.

#### 1.40 Warranty

- .1 This Trade shall furnish a written guarantee stating that all work executed under this contract will be free from defects of workmanship and materials for a period of two (2) years from the date of Substantial Performance. The period shall in no way supplement any other warranty of a longer period.
- .2 This Trade will at their own expense, repair and replace all such defective work and other work damaged thereby which fails or becomes defective during the term of the warranty provided that such failure is not caused by improper use.
- .3 Refer to the Division 01 specifications for additional warranty details.
- .4 Include for completion of the WRDSB Project Warranty Card prior to Substantial Performance.

## **2. THERMAL INSULATION**

### 2.1 General Requirements

- .1 All insulation shall be applied in general accordance with TIAC National Insulation Standards Manual, manufacturer's published instructions and requirements, and these specifications.
- .2 Apply covering in a neat workmanlike manner so that finished job is uniform and smooth in finish.
- .3 All insulation and components shall have maximum flame and smoke spread ratings of 25 and 50, respectively.

- .4 Ensure that all piping (including valves and fittings), ductwork and equipment are dry and clean before applying covering.
- .5 Do not apply insulation until the items to be covered have been tested against leakage.
- .6 Butt joints firmly together. Stagger joints in multiple layer construction. All joints shall be taped unless noted otherwise.
- .7 Locate longitudinal seams so as to be invisible.
- .8 Cover all joints with self-sealing 3" (75mm) wide butt strips provided by the insulation manufacturer or vapour barrier tape.
- .9 Install pipe insulation continuous through barriers (walls, ceilings, floors, etc.).
- .10 Install duct insulation continuous through barriers (walls, ceilings, floors, etc.) except at fire and combination fire / smoke dampers.
- .11 For cold water and storm water piping as well as for all duct thermal insulation, maintain integrity of vapour barrier jacket over all insulation, taking special precaution at fittings, valves, etc. For these systems:
  - a. Install insulation directly over pipes and not over hangers, supports, etc.
  - b. Protect pipe insulation with metal shields at all supports where such piping is 1.5" (38mm) NPS and larger. Shields shall be as follows:
    - i. Shields shall be formed to fit the insulation and shall extend up to the centerline of the pipe. They shall be of the length specified for the insulation hanger inserts less 4" (100mm) to allow for vapour retarding butt joints on each side of the shields.
    - ii. Shield gauges shall be as follows:
      - 1) 1.5" (38mm) to 3" (75mm) pipe: 20 gauge
      - 2) 4" (100mm) to 5" (125mm) pipe: 16 gauge
      - 3) 6" (150mm) and over pipe: 14 gauge
  - c. Ensure duct and pipe insulation is not broken at supports, hangers and standing duct seams. Where required, provide vapour barrier tape to maintain the integrity of the vapour barrier jacket at these locations.
  - d. Finish insulation ends with self-sealing 3" (75mm) wide butt strips provided by the insulation manufacturer or vapour barrier tape.
- .12 Protect insulation as follows:
  - a. Protect insulation passing through floors, walls and similar barriers to prevent damage.
  - b. Provide high density insulation inserts at all supports where insulation is protected by metal shields as follows (Trade to choose desired type):
    - i. Johns Manville Thermo-12 Gold or approved equal calcium silicate, rigid, sectional pipe and block type.
    - ii. Koolphen K-block having a density to suit load, complete with vapour barrier all service jacket and factory applied metal shield.
    - iii. Insulation thickness shall match that of the adjacent insulation.
    - iv. Insert lengths shall be as follows:

- 1) 1.5" to 2.5" (38 to 63mm) pipe size: 10" (250mm) long
  - 2) 3" to 6" (75 to 150mm) pipe size: 12" (300mm) long
  - v. For cold water piping, inserts shall be provided with vapour retarder seals and / or coatings.
  - c. Provide expansion and contraction joints in piping insulation for adequate movement without damage to insulation or finishes. Terminate single layer and each layer of multiple layer in straight cut at intervals recommended by manufacturer. Leave void of 1" (25mm) between terminations and pack with light density Fiberglas AF-300 Type 1.
- .13 Install insulation over equipment which may require service or replacement by maintenance staff (valves, unions, flanges, etc.) to be easily removable or replaceable without damage to adjacent insulation (use only pre-fabricated type insulation).
- .14 Valves, unions, flanges, etc. which are 1" (25mm) and smaller in domestic water systems, and heating water systems are not required to be insulated.
- .15 Existing pipe and duct insulation shall remain unchanged except that all existing insulation damaged during installation of new work shall be repaired.
- .16 Where asbestos insulation has been removed by the General Trade to permit new connections, new fiberglass insulation shall be installed by this Trade.

## 2.2 Pipe Insulation

- .1 Rigid Piping: Johns Manville Micro-Lok or approved equal, pre-moulded, glass fibre, rigid, sectional sleeve insulation with a K factor of 0.23 Btu-in/hr-ft<sup>2</sup>-°F (0.033 W/m-°C) at a mean temperature of 75°F (24°C) and jacketed with a factory applied reinforced vapour retarder facing having a longitudinal acrylic adhesive closure system. Thickness and application shall be as specified below.
- .2 Valves and Fittings: Pre-formed fittings or mitred segments to match adjacent pipe insulation. Where insulation is to be provided with PVC covers, insulation may be revised to Johns Manville Microlite Standard Type 150 or approved equal formaldehyde-free, flexible glass fibre, blanket insulation with a K factor of 0.24 Btu-in/hr-ft<sup>2</sup>-°F (0.035 W/m-°C) at a mean temperature of 75°F (24°C) and a factory applied FSK vapour barrier facing having a 2" (50mm) stapling tab.
- .3 Underside of Roof Drain Bodies: Insulated with 1" (25mm) thick Johns Manville Equipment Spin-Glas or approved equal rigid board insulation, 3.0 lb/ft<sup>3</sup> (48.1 kg/m<sup>3</sup>) density, with a K factor of 0.254 Btu-in/hr-ft<sup>2</sup>-°F (0.035 W/m-°C) at a mean temperature of 75°F (24°C) and a factory applied FSK facing. Secure insulation to underside of roof drain bodies using 3" (75mm) wide tape (pressure sensitive adhesive). In concealed locations, no additional finish is required. In exposed locations, provide PVC covering. Install to maintain integrity of vapour barrier jacket.
- .4 Install rigid fiberglass type insulation according to manufacturer's requirements and as follows:
  - a. Apply the SSL II Positive Closure System smoothly and securely as per the manufacturer's requirements, ensuring all contacting surfaces are kept clean.

- b. Apply insulation on valves, backflow preventers, strainers, unions, flanges, fittings, etc. prior to straight run insulation.
- c. Insulation on fittings shall be cut in proper segments to provide a tight fit or pre-formed fittings shall be used. Insulation on valves, backflow preventers, strainers, unions, flanges, etc. shall be pre-formed type only.
- d. All insulation for fittings shall be cut to suit the length of the body plus 2" (50mm) at each end.
- e. Any void between the insulation on fittings, valves, backflow preventers, strainers, unions, flanges, etc. and the straight run insulation shall be filled with insulation segments cut to fit the gap.
- f. If a continuous vapour barrier is specified, finish insulation ends with self-sealing 3" (75mm) wide butt strips provided by the insulation manufacturer or vapour barrier tape.

.5 Finish Covering for Insulation (Interior of Building):

- a. Leave as All Service Jacket (ASJ) or FRK finish except as otherwise noted below.
- b. All interior exposed pipe insulation shall be provided with PVC jacketing, Proto or approved equal as follows:
  - i. Insulation located within suspended ceiling spaces, cabinet spaces and walls will not be considered exposed.
  - ii. System shall consist of one piece and two piece pre-moulded high impact LoSMOKE PVC pipe and fitting covers with all required accessories, which include elbows, tees, valves, end caps, mechanical line couplings, specialty fittings, tank end panels, tack fasteners, tapes and specialty items. Jacket shall be bright high-gloss white colour.
  - iii. Jacket shall have flame spread rating and smoke developed classification of 25 and 50, respectively.
  - iv. Jacket shall not promote the growth of fungi or bacteria.
  - v. Where desired by Trade, fibreglass inserts which comply with the insulation specifications may be provided.
  - vi. Jacket shall be 0.02" (0.5mm) thick with standard one piece fitting cover.
  - vii. Apply according to manufacturer's requirements and as follows:
    - 1) Apply on clean, dry surfaces.
    - 2) Do not apply jacket too tightly. Install slide joints and jacket to prevent cracks and puckering.
    - 3) Jacket shall be cut and rolled to fit the circumference of pipe plus a 2" (50mm) overlap.
    - 4) Apply PVC adhesive bead (Red Devil Inc. Celulon or approved equal, water based, clear) along longitudinal edge, approximately 1" (25mm) in from edge, and apply jacket over adhesive using firm pressure for attachment. Temporarily hold PVC jacket in place using masking tape until firmly attached.
    - 5) Provide PVC end caps at all insulation endpoints (caulked joints will not be permitted).
    - 6) Any corners or cracks shall be neatly finished with a white silicone caulking bead.
    - 7) Secure throats of fitting, valve, etc. covers by either tack fastening or taping (do not use tacks where a vapour barrier insulation system is specified). For insulation systems required to have a vapour barrier

insulation, use Proto PVC tape with a minimum 2" (50mm) downward overlap.

- .6 Finish Covering for Insulation (Exterior of Building):
- a. All exterior pipe insulation shall be provided with 0.016" (0.40mm) stucco embossed aluminum jacketing as follows:
    - i. The jacket shall be cut to fit the circumference of the insulation with a 2" (50mm) overlap.
    - ii. Position all joints to shed water.
    - iii. The longitudinal joint shall be secured with 0.5" (13mm) long #8 stainless steel screws installed at maximum 6" to 8" (150 to 200mm) centres except that screws will not be permitted for piping which is electrically heat traced. For piping equipped with electric heat trace cable, secure jacket with 0.5" (13mm) wide by 0.020" (0.5mm) thick stainless steel banding installed as follows:
      - 1) At maximum 18" (450mm) centres.
      - 2) On either side of each transverse joint in the jacketing.
    - iv. Provide a safety edge for all exposed longitudinal edges.
    - v. End caps shall have a 0.125" (3.1mm) male bead to insert into the female end of the straight run jacket. The edge of the straight run jacket shall be hammered down over the end cap.
    - vi. The jacket at valve handles shall be neatly cut around the protrusion and the resulting opening shall be caulked.
    - vii. Provide aluminum jacketing elbow fitting covers as follows:
      - 1) Jacket shall be 0.016" (0.40mm) minimum thickness.
      - 2) Overlap with straight run jacket by minimum 2" (50mm) and position all joints to shed water.
    - viii. All unfinished edges, cut-outs, transverse joints, longitudinal joints, screws or other locations where water infiltration is possible shall be sealed with aluminum coloured silicone caulking. For jacket overlaps, the caulking shall be applied between the overlaps, 1" (25mm) from the edges.
- .7 Pipe insulation thicknesses shall be as follows:
- a. Copper Cold Water: 0.5" (13mm).
  - b. Copper Hot Water: 1" (25mm).
  - c. Metal Heating Water (Supply and Return):
    - i. Heating water piping 1.25" (32mm) and smaller shall be provided with 1.5" (38mm) insulation.
    - ii. Heating water piping 1.5" (38mm) and larger shall be provided with 2" (50mm) insulation.
  - d. Metal Cooling Coil Condensate: 0.5" (13mm).
  - e. Plastic Cooling Coil Condensate: No insulation required.
  - f. Aboveground Plastic and Metal Horizontal Storm Water (including fittings where piping turns from vertical to horizontal and horizontal to vertical): 1" (25mm).
    - i. Horizontal is defined as storm water piping with less than 10% slope.
    - ii. Underside of roof drain assemblies shall be provided with 1" (25mm) insulation.

### 2.3 Duct Insulation (Interior of Building)

- .1 Johns Manville Microlite XG Type 75 or approved equal formaldehyde-free, flexible glass fibre, blanket insulation with a K factor of 0.27 Btu-in/hr-ft<sup>2</sup>-°F (0.039 W/m-°C) at a mean temperature of 75°F (24°C) and a factory applied FSK vapour barrier facing having a 2" (50mm) stapling tab. Provide as follows:
  - a. In concealed locations, where insulation is required on rectangular ductwork as indicated on drawings and as per below. Concealed locations include ceiling spaces (including suspended), bulkheads, cabinet spaces, walls, etc.
  - b. In exposed locations, where insulation is required on round ductwork as indicated on drawings and as per below. Concealed locations include ceiling spaces (including suspended), bulkheads, cabinet spaces, walls, etc.
- .2 Johns Manville 800 Series Spin Glas or approved equal 3.0 lb/ft<sup>3</sup> (48.1 kg/m<sup>3</sup>) density rigid board insulation with a K factor of 0.23 Btu-in/hr-ft<sup>2</sup>-°F (0.035 W/m-°C) at a mean temperature of 75°F (24°C) and a factory applied FSK vapour barrier facing. Provide as follows:
  - a. In exposed locations, where insulation is required on rectangular ductwork as indicated on drawings and as per below. Exposed locations exclude ceiling spaces (including suspended), bulkheads, cabinet spaces, walls, etc.
  - b. Ductwork shall be provided with 2" (50mm) insulation unless otherwise noted.
- .3 Insulation fasteners shall be 12 gauge (2mm) zinc coated steel pins at 16" (400mm) to 18" (450mm) on center complete with minimum 1.5" (38mm) square plastic or zinc plated steel self-locking washers. Alternatively, use Continental spindle anchors held in place with Tac Two or approved equal adhesive at 16" (400mm) to 18" (450mm) on center.
- .4 Insulation self-adhesive tape shall be MacTac Canada Ltd. or Venture Tape, ULC listed.
- .5 Flexible insulation shall be applied as follows:
  - a. Cut to have a 3" (75mm) minimum overlap.
  - b. On round ductwork, provide one row of welded or glued on spindle anchored pins on top or side section at 12" (300mm) centers (length of pins shall suit ductwork). Proper washers shall be pressed on the pins and the ends of the pins cut before sealing with a piece of 4" (100mm) tape. On round ductwork 14" (350mm) and smaller, 0.5" (13mm) wide 20 gauge stainless steel banding may be used as an alternate to the anchoring pins (install bands at 12" (300mm) on center).
  - c. On rectangular ductwork, apply as specified for round ductwork where dimensions do not exceed 16" (400mm) in total on the four sides. On larger ductwork, the sides and bottom shall have stud welded pins or spindle anchored pins glued on at 16" (400mm) to 18" (450mm) on center.
  - d. All pin penetrations or punctures and all circumferential and longitudinal joints in jacket shall be sealed with a 4" (100mm) vapour barrier tape.
  - e. Refer also to manufacturer's requirements.
  - f. All exposed flexible insulation on round ductwork shall be covered with PVC jacketing, Proto or approved equal as follows:
    - i. System shall consist of one piece and two piece pre-moulded high impact LoSMOKE PVC duct and fitting covers with all required accessories, which include elbows, tees, end caps, specialty fittings, tack fasteners, tapes and specialty items. Jacket shall be bright, high-gloss white colour.

- ii. Jacket shall have flame spread rating and smoke developed classification of 25 and 50, respectively.
  - iii. Jacket shall not promote the growth of fungi or bacteria.
  - iv. Jacket shall be 0.02" (0.5mm) thick with standard one piece fitting cover.
  - v. Apply according to manufacturer's requirements and as follows:
    - 1) Apply on clean, dry surfaces.
    - 2) Do not apply jacket too tightly. Install slide joints and jacket to prevent cracks and puckering.
    - 3) Jacket shall be cut and rolled to fit the circumference of pipe plus a 2" (50mm) overlap.
    - 4) Apply PVC adhesive bead (Red Devil Inc. Celulon or approved equal, water based, clear) along longitudinal edge, approximately 1" (25mm) in from edge, and apply jacket over adhesive using firm pressure for attachment. Temporarily hold PVC jacket in place using masking tape until firmly attached.
    - 5) Provide PVC end caps at all insulation endpoints (caulked joints will not be permitted).
    - 6) Any corners or cracks shall be neatly finished with a white silicone caulking bead.
    - 7) Secure throats of fitting covers by taping. Use Proto PVC tape or equivalent with a minimum 2" (50mm) downward overlap.
  - vi. Where desired by Trade, fibreglass inserts which comply with the insulation specifications may be provided.
- .6 Rigid insulation shall be applied as follows:
- a. Cut to fit between standing seams and stiffeners.
  - b. Apply welded or glued on pins installed at maximum 18" (450mm) on center. Apply pins with reduced clearances where necessary to properly secure insulation.
  - c. Apply to top of duct first, with edges of insulation even with edges of ductwork.
  - d. Next apply to sides of duct by cutting board to cover the top edge of insulation and to be even with the bottom edge of the duct.
  - e. Next apply to bottom of duct by cutting board to be even with the outside edges of the side insulation.
  - f. Mechanical washers shall be applied as the board is being installed. Cut the remainder of the unnecessary pins.
  - g. At corner, joints and washers, a 4" (100mm) tape shall be used to seal all joints and maintain integrity of vapour barrier.
  - h. Where elbows occur, slit board at 1" (25mm) centers in a "V" type cut where necessary to soften the board.
  - i. Provide drywall type metal corner beads on edges of insulation, secured in place with tape.
  - j. Refer also to manufacturer's requirements.
- .7 Insulation shall be provided as indicated on drawings and as per the following:
- a. Supply ductwork in unconditioned spaces (not air-conditioned) including ceiling spaces (not used as a return air plenum), bulkheads, cabinet spaces, walls, etc.
  - b. First 8'-0" (2.4m) of supply, return, intake (outdoor air) and exhaust ductwork on interior side of exterior wall, roof, etc. penetrations.
  - c. Intake (outdoor air) ductwork located in interior of building.



- d. Plenum (intake (outdoor air) and exhaust), including entire wall box, located in interior of building.
- e. Thermal insulation is not required where 1" (25mm) acoustic insulation is provided. Note, 0.5" acoustic insulation is not a sufficient substitute for required thermal insulation.

#### 2.4 Duct Insulation (Exterior of Building)

##### .1 Rectangular Ductwork:

- a. Unless noted otherwise, provide Johns Manville "800 Series Spin Glas" or approved equal rigid board type insulation, type 814, 3.0 lb./cu.ft. (48 kg./cu.m.) density, with a K factor of 0.23 Btu-in/hr.-sq.ft.-deg.F (0.033 W/m.-deg.C) at a mean temperature of 75 deg. F. (24 deg. C.) and a factory applied FSK facing. Provide one layer of 3" (75mm) thickness. Insulation shall be cut and fit tightly between standing seams.
- b. For ductwork over 3'-0" (900mm) wide, revise insulation on the top surface of the duct only to 6.0 lb./cu.ft. (96 kg./cu.m.) density.
- c. Secure with 12 gauge (2mm) zinc coated steel pins complete with minimum 1.5" (38mm) square plastic or zinc plated steel self-locking washers. Alternatively, use Continental spindle anchors held in place with adhesive. Apply pins on the sides, bottom and top at 16" (400mm) to 18" (450mm) centers. On smaller surfaces, apply pins at center of duct on all sides.
- d. On the bottom surface only of ductwork wider than 48" (1200mm), provide a back-up strip of 3" (75mm) wide 0.025" (0.625mm) aluminum (minimum) which is installed on top of the pins and held in place with washers (the portion of the pin beyond the washer shall be cut off). Strips shall be installed at maximum 18" (450mm) centers.
- e. Unless noted otherwise, all washers, joints, corners, strips, terminations and punctures in jacket shall be taped with minimum 3" (75mm) wide RFFRK tape.
- f. Thermal insulation shall be terminated at duct support frames as follows:
  - i. Insulation shall be butted tight to the support frame. Note that tape is not required to be applied to this termination.
  - ii. The channel of the support frame shall be packed with insulation.
  - iii. Two strips of 3" (75mm) wide tape shall be applied to bridge the support frame and to maintain a continuous vapour barrier. The strips of tape shall overlap by approximately 1" (25mm) and shall be centered on the channel support frame.

##### .2 Aluminum Cladding for Rectangular Ductwork:

- a. All exterior duct insulation shall be provided with a 0.025" (0.625mm) stucco embossed aluminum sheet finish applied according to the detail on the drawings and as follows:
  - i. All cladding shall have a maximum length of 3'-0" (900mm) measured longitudinally along the duct.
  - ii. All transverse joints (top, bottom and two vertical sides of the duct) shall be made with 1.5" (38mm) standing seams which are capped with a 1.5" (38mm) tall cleat which is constructed of 0.020" (0.5mm) stucco aluminum. All cleats shall be constructed with a safety edge on the two long sides.
  - iii. All longitudinal joints shall have a minimum 2" (50mm) overlap configured to shed water.

- iv. All vertical corner joints shall have a minimum 4" (100mm) overlap (overlap by 2" (50mm) on either side of the corner).
  - v. Provide aluminum coloured caulking in all cladding openings where water penetration is possible, including all transverse corner joints and where duct supports penetrate the cladding.
  - vi. 0.5" (13mm) long #8 stainless steel screws shall be used in the following locations to secure the aluminum sheeting:
    - 1) Along all longitudinal, transverse and vertical corner joints. All screws shall be installed at 6" to 8" (150 to 200mm) centers.
    - 2) On the bottom surface only of ductwork wider than 48" (1200mm), screws shall be provided at maximum 18" (450mm) centers (install in the locations of the aluminum back-up aluminum strips).
  - vii. Cladding on radiused duct fittings shall be constructed with a Pittsburgh seam. Notching of straight metal sections will not be permitted.
- b. For additional information, refer to the detail on the drawings.

.3 Waterproof Jacket for Rectangular Ductwork:

- a. Polyguard Alumaguard 60 or approved equal ultraviolet resistant, weather proof, vapour barrier jacketing system composed of a rubberized bitumen compound, heat applied to a cross-laminated high strength polyethylene film, laminated to an aluminum foil surface. The membrane shall be supplied in rolls and shall be laminated to a disposable release sheet. The waterproofing membrane shall be applied according to the manufacturer's recommendations and approximately as follows:
  - i. Cut one piece of the membrane to cover the underside of the duct and up 4" (100mm) on each side.
  - ii. Cut two pieces of the membrane to fit from the bottom corner of the duct up over the top of the duct, lapping over the top.
  - iii. Cut the final piece of the membrane to cover the top of the duct and 4" (100mm) down on each side.
  - iv. Roll the membrane and laps with a laminate roller or firm "rolling pin" type roller.
  - v. Where permitted by the manufacturer, on smaller ducts a one piece installation may be performed by cutting to length and installing the membrane overlapping onto itself a minimum 6" (150mm). The piece shall be started on the top or bottom of the duct in a manner that the overlap terminates at the top or bottom edge of the duct.
  - vi. Ductwork exceeding 24" (600mm) in width shall be pinned through the membrane on the bottom of the duct. Provide a 4" (100mm) square of the membrane over the washer to prevent moisture penetration, limit thermal conductance and prevent rusting of the pin and washer.
  - vii. When installing the membrane in temperatures below 50 degrees F. (10 degrees C), a heat gun shall be used to ensure adhesion. Where directed by the manufacturer, provide a Polyguard cold weather activator to ensure proper adhesion.
  - viii. All duct supports, insulation fasteners or other materials which could puncture the outer membrane shall be first covered with a 4" (100mm) square of the membrane.
  - ix. The insulation on the top of the duct shall be shimmed to permit shedding of water.

- .4 Note that thermal insulation will be required in addition to acoustic insulation indicated on the drawings.
- .5 Upon completion of initial HVAC system, arrange for review by Consultant and obtain approval prior to proceeding with remaining work.

### **3. ELECTRICAL**

#### **3.1 Electrical Wiring**

- .1 Unless noted otherwise, power wiring for mechanical equipment shall be provided by the Electrical Trade and this Trade shall provide all controls complete with all low voltage wiring (less than 50V).
- .2 The Electrical Trade shall provide starters, overload protection and disconnects for equipment supplied by this Trade unless noted otherwise. Refer to Wiring for Equipment Schedule on electrical drawings for detailed requirements.
- .3 Line and low voltage electrical work provided by this Trade shall be done in accordance with and to the standards outlined in the electrical specification.
- .4 Control wiring and transformers shall be class 1 or 2 as required by the Ontario Electrical Safety Code (OESC) to suit system operating voltages and currents.
- .5 Control wiring shall be the shielded type and of a type as recommended by the manufacturer. Wiring running concealed shall not run in conduit unless otherwise required by the OESC. Take all necessary precautions to ensure electromagnetic interference from other wiring systems within the building does not affect the operation of the mechanical control systems.
- .6 Where control wiring is installed in return air plenums, use wiring having maximum flame and smoke ratings of 25 and 50 respectively.
- .7 Wiring sizes and transformer capacities shall be suitable to service all control equipment and to accommodate voltage drops in wiring systems.
- .8 Control wiring shall run concealed except as follows:
  - a. In the following locations, wiring may run exposed on surface in conduit. All conduit shall be supplied and installed by this Trade.
    - i. Wiring running on walls or ceilings in Mechanical / Electrical Rooms.
    - ii. Wiring running on ceilings in spaces having no suspended ceilings.
  - b. Exposed control wiring will not be permitted (run in conduit as described above).
  - c. Where not possible to run concealed in spaces other than listed above, surface mount in wiremold. All wiremold shall be supplied and installed by this Trade and shall be of a type approved by the Consultant.

**END OF SECTION**

## **1. GENERAL**

### 1.1 General Requirements

- .1 Refer to Division 20 – Mechanical.

## **2. PLUMBING AND DRAINAGE**

### 2.1 Supports

- .1 Provide all of the required pipe hangers and supports.
- .2 Pipe and equipment supports shall be Grinnell or approved equal of spacing and type as recommended by manufacturer, in accordance with Code requirements and in accordance with good commercial standards.
- .3 Provide supports to secure pipes, prevent pipe vibration, maintain required grading, allow for expansion and contraction and produce a neat appearance. Design for strength and rigidity to suit loading and services, prevent undue stress to structural members and with provision for vertical adjustment after piping is erected.
- .4 Anchor / support risers so that weight is not transferred to connected horizontal piping.
- .5 Offset hanger pipe and structural attachments in such a manner that rod is vertical when piping is hot and is subject to tensile loading only.
- .6 Adjust hanger rods to equalize load.
- .7 For all piping systems specified to have insulation with a continuous vapour barrier (refer to Insulation), oversize pipe hangers and supports to accommodate insulation.
- .8 Provide supplementary structural steelwork where structural bearings do not exist
- .9 Where supporting from open web steel joists, attach supports to the approval of the structural engineer and comply with the following:
  - a. For all piping, attach supports to the top angle iron section of joists only.
  - b. For piping 3" (75mm) and larger running parallel to joists, provide supplementary steelwork so that piping is supported from a minimum of two joists.
  - c. Support from panel points only.
  - d. Hanger spacing shall not exceed 10'-0" (3.0m).

### 2.2 Domestic Water Piping

- .1 Above Ground (Contractor to choose desired type):
  - a. 3" (75mm) and under: type "L" hard copper tubing with sweat wrought copper pressure type solder joint fittings.
- .2 Connections
  - a. Lead-free solder for Type L copper.

### 2.3 Sanitary Drain and Vent Piping

- .1 Above Ground (Contractor to choose desired type):
  - a. 2" and under: type DWV hard drawn copper tube with cast brass alloy drainage fittings.
  - b. Over 2": Cast iron pipe with "MJ" fittings or DWV copper tubing with cast alloy drainage fittings.
  - c. All sizes: PVC DWV pipe with injection-molded socket fittings. Pipe shall be suitable for use in non-combustible building construction (IPEX System 15 or approved equal). For piping running through return air ceiling plenums, piping shall have a maximum smoke developed rating of 50 (IPEX System XFR 15-50 or approved equal).
- .2 Connections:
  - a. 50-50 lead-tin solder for DWV copper.
  - b. Stainless steel screw clamps and elastomer sleeve for mechanical joint cast iron soil pipe, Bibby-Ste-Croix series 2000 or approved equal.
  - c. Solvent weld all socket fittings according to manufacturer's recommendations.
- .3 All piping shall conform to or be certified by the appropriate CSA standard according to OBC requirements.
- .4 Un-insulated plastic piping will not be permitted to run exposed in any location. Use only copper or cast iron piping in these locations.
- .5 Plastic piping will not be permitted to run exposed less than 8'-0" (2400mm) above the finished floor in any location (unless approved by Owner or where protected by equipment, block enclosure, etc.) to prevent pipe from being damaged. Use only cast iron piping in these locations including where piping runs within Mechanical / Electrical / Storage / Custodial Rooms.

### 2.4 Storm Drain Piping

- .1 Above Ground (Contractor to choose desired type):
  - a. All sizes: cast iron with "MJ" fittings.
  - b. All sizes: PVC DWV with injection-molded socket fittings. Pipe shall be suitable for use in non-combustible building construction (IPEX System 15 or approved equal). For piping running through return air ceiling plenums, piping shall have a maximum smoke developed rating of 50 (IPEX System XFR 15-50 or approved equal).
- .2 Connections:
  - a. Stainless steel screw clamps and elastomer sleeve for mechanical joint cast iron soil pipe, Bibby-Ste-Croix series SD 4000 heavy duty type or approved equal.
  - b. Solvent weld all socket fittings according to manufacturer's recommendations.
- .3 All piping shall conform to or be certified by the appropriate CSA standard according to OBC requirements.

- .4 Un-insulated plastic piping will not be permitted to run exposed in any location. Use only copper or cast iron piping in these locations.
- .5 Plastic piping will not be permitted to run exposed less than 8'-0" (2400mm) above the finished floor in any location (unless approved by Owner or where protected by equipment, block enclosure, etc.) to prevent pipe from being damaged. Use only cast iron piping in these locations including where piping runs within Mechanical / Electrical / Storage / Custodial Rooms.

## 2.5 Compressed Air Piping

- .1 Compressed air piping up to and including 2" (50mm) shall be standard weight, Schedule 40 ERW black steel pipe to ASTM A53 Grade B with malleable iron screwed fittings Class 150 to ASTM A197. All piping and materials shall be complete with mill test reports or a letter provided from the supplier stating compliance with the Ontario Boilers and Pressure Vessels Act. All fittings shall be registered. Copies of this information shall be kept on site and made available for the Inspector.
- .2 Fittings shall be to the following as applicable:
  - a. malleable iron screwed fittings, Class 150 to ANSI B16.3-1977.
  - b. unions, malleable iron to ANSI B16.3-1977.
  - c. all fittings shall be long radius type.
- .3 Connections shall be to the following as applicable:
  - a. piping NPS 2" (50mm) and under, screwed.
  - b. nuts and bolts shall be carbon steel square head machine bolts and heavy hex head nuts, to ANSI B18.2.1-1981 and ANSI B18.2.2-1972.
  - c. for screwed piping connections, use dope or teflon tape (pipe thread taper to ANSI B2.1-1968).
- .4 The system shall be registered by the Mechanical Contractor with the Ministry of Consumer and Commercial Relations Pressure Vessels Safety Branch / Technical Standards and Safety Authority (TSSA) prior to installation. All fees shall be billed as an extra to the contract.
- .5 Prior to purchase of any materials, the Contractor shall verify that all materials, fittings, installation methods, testing, etc. meet the approval of the local Inspector.
- .6 All testing shall be done using two calibrated test gauges and the range of the gauges shall be twice the test pressure. The complete piping system shall be tested with air at 1.2 times the safety valve setting on the air compressor / 1.5 times the maximum working pressure (use larger pressure) for a minimum period of 4 hours or as directed by the Inspector. The test shall be made so as not to impose excessive pressure on all equipment not rated for the test pressure. Joints shall be checked with a soap and water solution where required and as directed.
- .7 Slope all horizontal piping to drain to the compressor or manual blow-off as shown on the drawings. Slope with a minimum fall of 0.5" (13mm) in 10'-0" (3000mm) horizontal run. Where possible, install all piping without pockets where condensate may accumulate and if not possible, provide trap assemblies to remove all condensate.

- .8 Make all branch pipe connections to top of mains.

## 2.6 Natural Gas Piping

- .1 Piping shall be black steel schedule 40 to ASTM A53 or A106 with screwed malleable iron or steel fittings up to 2" (50mm) and welded fittings over 2" (50mm). All piping and fittings (including pipe thread tape) shall comply with the requirements of the latest issue of CSA B149.1.
- .2 De-energize and re-energize all affected natural gas systems to permit the revisions indicated on the drawings. Re-light all existing natural gas equipment affected by the new Work.
- .3 The gas distribution system shall be supplied, installed, tested and identified according to CSA International B149.1-00 Natural Gas And Propane Installation Code and local authority requirements. All outside piping shall be painted (identification banding not acceptable).
- .4 Mount and fasten all gas piping running on roof on one of the following:
- a. Roof Top Blox or approved equal model RTB-01 having the following features / accessories:
    - i. Black UV stabilized high density polyethylene, 0.1" (2.5mm) to 0.135" (3.4mm) wall thickness.
    - ii. Base material shall be 1" (25mm) thick by 25 lb. density Type 3 closed cell extruded polystyrene foam.
    - iii. Supports shall have end-to-end interlocking capability.
    - iv. Load bearing capability up to 450 lbs. (205 Kg.). For loads over 250 lbs. (115 Kg.), provide model STR-04 galvanized slotted steel strut channel.
    - v. Screw indents to guide fastening screws into internal engineered thread gripping feature.
    - vi. Top surface easily adapts to all types of piping clamps, clips, slotted strut and 0.375" (9.4mm) or 0.5" (13mm) treaded rod.
    - vii. All pipe fastening and height adjustments shall be done from the top side only.
    - viii. Provide all accessories required for mounting of piping, including (where applicable) model XTB-02 height extension, model ROD-03 zinc plated extension rods, model STR-04 galvanized slotted steel strut channel, etc
    - ix. All supports shall have the capability to fasten pipe clamps.
    - x. Provide galvanized pipe clamps / fasteners at all supports for pipe attachment. Clamps shall be one size larger than the pipe.
    - xi. Refer also the detail on the drawings.
  - b. Mifab CXP / C series (as applicable) or approved equal block supports manufactured completely of UV resistant 100% recycled rubber. Provide CE extension series where required by elevation of piping.
    - i. All supports shall have the capability to fasten pipe clamps.
    - ii. Provide galvanized pipe clamps / fasteners at all supports for pipe attachment. Clamps shall be one size larger than the pipe.
  - c. Refer also to the detail on the drawings.

## 2.7 Gas Pressure Regulators

- .1 Gas pressure regulators shall be Fisher Controls or approved equal, HSR, CS200, CS400 or CS800 series complete with internal relief and internal outlet pressure registration. Sizing of valve shall be by manufacturer to suit gas pressure and flowrate, and to reduce the indicated natural gas flowrate from a pressure from 5 PSI (34.5 kPa) to 7" (175mm) w.c. The valve nominal pipe size shall match line inlet size shown on the drawings or shall be maximum one pipe size smaller than the indicated inlet size.

## 2.8 Sanitary and Storm Cleanouts

- .1 Zurn or approved equal of the following types (Contractor to choose applicable type):
  - a. In piping systems not terminating through building finishes, provide compatible cleanout fittings as manufactured by the pipe manufacturer. Access doors shall be provided as specified elsewhere in the specification.
- .2 Cleanouts have been indicated where desired in specific locations. In all other locations, provide cleanouts according to Ontario Building Code requirements and/or where directed by the local authority. Cleanouts shall be installed tight to walls where indicated on the drawings.

## 2.9 Roof Drains

- .1 Zurn or approved equal. Drains shall be dura coated cast iron body with underdeck clamp, roof sump receiver, insulation extension (where required), plastic dome and shall be of the following types:
  - a. RD: Standard roof, Z-121-E-R-C / Z-121-DP.
  - b. RD: Inverted (IRMA) roof with stainless steel gravel guard, Z-121-SS-R-C.

## 2.10 Valves

- .1 General
  - a. All valves shall have a pressure rating suitable for the system operating pressure. All valves shall meet MSS-SP-25, the manufactures name and pressure ratings are clearly marked on the body of the valve. Valves to meet current MSS specifications.
  - b. Similar valves shall be of the same manufacturer.
  - c. All valves supplied for this project shall have a current and valid Canadian Registration Number for the Province of Ontario with TSSA. Suppliers shall provide a copy of the Statutory Declaration for valves, stamped, signed and dated by TSSA as validation of the CRN registration. This shall be provided along with the shop drawing submittal package.
  - d. Provide stem extensions / extended necks as required to suit insulation thickness.
  - e. All domestic water valves shall be lead-free compliant containing less than 0.25% lead by weight copper alloy bodies. Valves to be certified to NSF 372: Use only original manufactured valves meeting ANSI, ASTM, ASME and applicable MSS standards.
  - f. All valves shall meet MSS-SP-25, the manufacturers name and pressure ratings are clearly marked on the body of the valve. Valves meet current MSS specifications.
  - g. Use only industrial class valves meeting ANSI, ASTM, ASME and applicable MSS standards. Specification MSS-SP-80, MSS-SP-110, MSS-SP-70, 85, 71, MSS-SP-72, MSS-SP-67, API 602, API 598, API 609, API 600.



- .2 Isolation Valves (Domestic Hot and Cold Water):
- a. Sizes 0.5" (13mm) to 2" (50mm): 1034 kPa (150 psig) / 600 W.O.G., Brass Body to ASTM C49300 (Lead Free Brass), Full Port, PTFE Seats, Double "O" Ring or PTFE Packing, (Sni)Silver Nickel Plated Forged Brass C49300 Vented Solid Ball or Stainless Steel Ball, Blowout Proof Stem, Lever Handle.
    - i. Threaded valves: Kitz 868AMLL or approved equal.
    - ii. Soldered valves: Kitz 869AMLL or approved equal
  - b. Sizes 2.5" (63mm) to 10" (250mm): American Valve #4000 or approved equal. Cast Iron ASTM A126 Class B Body, Epoxy Coated to NSF 61/NSF 372. Teflon Fused Ball, RPTFE Seats, Seals and Packing, Tapped & plugged boss for venting or draining downstream side. Full Port up to 6", Locking Lever Operated, and Gear Operated.
- .3 Isolation Valves (Natural Gas):
- a. Sizes 0.25" (6mm) to 2" (50mm): MAS B3 or approved equal. 150PSIG/ 600WOG Rating Brass body, Full port, TFE seats, Double O-Ring Design, or Teflon packing, Chrome plated solid Bronze ball, 3.16 Rating, CGA/CSA Approved, and Lever Handle.
  - b. Sizes 2.5" (63mm) and larger: Kitz 150 SCTDZM-N or approved equal. Class 150 Flanged, Carbon Steel A216WCB Body, S.S. Ball & Stem, PTFE packing, Co-Polymer Hypatite seats, Locking Lever or Gear.
  - c. All exterior valves not located on the roof shall be complete with removable handles.
  - d. All valves shall be manufactured in accordance with International Fuel Gas Code, CGA 3.16, UL, CGA-B 149.M91 as revised.
- .4 Isolation Valves (Compressed Air):
- a. Sizes 2" (50mm) and under: Apollo 70-140 or approved equal, two piece bronze ball valve, blowout-proof stem, stainless steel ball and stem, mult-filled RPTFE seats, RPTFE seals / stem bearing, ASTM B584 bronze, high temperature MTFE stem packing, thermal relief ball design, 600 Psig (4135 Kpa) WOG cold non-shock.
- .5 Drain Valves:
- a. 860 kPa (125 psig) / 200 W.O.G. bronze body to ASTM C89530 (Lead Free Bronze), Screwed Cap C49300 (Lead Free Brass), Integral Seat, Bronze or PTFE Disk.
    - i. Threaded valves: Kitz 868C or approved equal.
    - ii. Soldered valves: Kitz 869C or approved equal.
  - b. Where required by the local authority, provide tamper proof vacuum breaker.

### 2.11 Shock Absorbers

- .1 Shock absorbers shall be located and sized in accordance with Plumbing and Drainage Institute standard no. WH201-PD-1. Absorbers shall be Zurn Wilkins or approved equal, 1250XL series.

### 2.12 Piping Installation Requirements

- .1 Piping shall be installed according to good commercial standards and approximately as follows:

- a. All piping running vertically shall run concealed in wall construction / furred enclosures unless noted otherwise on the drawings.
  - b. Use compression joints, unions, flanged or grooved joints in sufficient quantities to facilitate removal of equipment, fixtures, etc. without removal of long lengths of pipe.
  - c. Install eccentric reducers in horizontal piping to permit drainage and eliminate air pockets.
  - d. Where pipe sizes differ from connection sizes of equipment, install reducing fittings close to equipment. Reducing bushings are not permitted.
  - e. All valves and other pipe accessories shall match the associated pipe size unless noted otherwise.
  - f. Cut ends of pipes square, ream, clean scale and dirt and assemble without binding.
  - g. Install copper tubing so that it is not in contact with dissimilar metal and will not be kinked or collapsed.
  - h. Plug or cap pipe and fittings to keep out debris during construction.
  - i. All piping shall be laid straight and in true alignment to the slopes of the pipe, as indicated on the drawings and / or as directed.
  - j. Install piping free from strains and with proper allowance and off-sets for thermal expansion and contraction.
- .2 Piping shall be graded as follows:
- a. Water Piping: Minimum 1/20" per foot (0.43mm/100mm) length. Insure all piping can be drained and provide drain valves at all low points.
  - b. Sanitary Drains: Minimum slopes as required by Code or as otherwise noted on the drawings.
  - c. Storm Drains: Minimum 1% unless noted otherwise on the drawings.
  - d. Condensate Drains: Minimum 2%.
- .3 Keep all sanitary, storm and water piping clear of outside walls and combustion air openings unless otherwise noted on the drawings / unless otherwise required by site conditions / unless otherwise approved by the Consultant. It is the responsibility of this Contractor to ensure that water lines in outside walls or attic spaces are run on warm side of building insulation and adequately covered with insulation. It is the responsibility of this Contractor to ensure that plumbing piping is installed so that freezing conditions within the pipe do not occur.
- .4 Install a minimum of 24" (600mm) straight run piping between pipe elbows, valves or other fittings in recirculating water systems.

### 2.13 Draining Water Systems

- .1 Drain and refill as applicable all existing water systems as required to permit revisions as indicated on the drawings.

### 2.14 Testing and Inspection

- .1 Test drainage, vent and domestic water piping to Plumbing Code requirements. Test natural gas piping systems to Gas Code requirements. Repair all leaks to the inspection authority and / or the Consultant's approval.
- .2 All leaks shall be repaired by remaking the joint. After piping systems have been tested and repaired, repeat tests.

- .3 All equipment / devices which may be damaged by test pressures shall be isolated during testing procedures.

### 2.15 Cleaning and Flushing

- .1 Disinfect all new domestic water piping as follows:
- a. Inject Quatic Chemicals Q-CHLOR or approved equal cleaning agent into the water system at a rate of 20 lbs (9.1 Kg.) per 1000 USG (3785 L).
  - b. Operate valves, faucets and similar appurtenances while the piping contains chlorine solution.
  - c. Measure chlorine residuals at the extreme end of each piping circuit. After a chlorine residual of not less than 50ppm has been obtained, leave the system for 24 hours.
  - d. Flush completely, test for residual and flush again as necessary to remove all cleaning solution.
  - e. Perform a water quality / bacteria analysis prepared by an independent lab to verify that the system is clean and suitable for consumption, and certifying that the chlorine content is less than 10ppm.
- .2 Flush and clean all new and existing affected piping in the following sequence:
- a. Flush with potable water for a minimum time period of 30 minutes. During flushing and cleaning maintain all isolating valves in the open position. Remove faucet strainers during flushing and replace once flushing is complete.
  - b. Disinfect all new piping for three hours using a 200 ppm chlorine solution.
  - c. After disinfection, flush all new and affected existing piping with potable water for a minimum time period of 30 minutes.
  - d. Perform a water quality / bacteria analysis prepared by an independent lab to verify that the domestic water system downstream of each Tenant water meter is clean and suitable for consumption. Take each sample at the most downstream end of each piping system.
- .3 All cleaning and flushing of the domestic water site service piping shall be by the Site Service Contractor.
- .4 During flushing and cleaning maintain all isolating and control valves in the open position.

**END OF SECTION**

## **1. GENERAL**

### **1.1 General Requirements**

- .1 Refer to Division 20 – Mechanical.

## **2. HOT WATER HEATING**

### **2.1 Supports**

- .1 Provide all of the required pipe hangers and supports.
- .2 Pipe and equipment supports shall be Grinnell or approved equal of spacing and type as recommended by manufacturer, in accordance with Code requirements and in accordance with good commercial standards.
- .3 Provide supports to secure pipes, prevent pipe vibration, maintain required grading, allow for expansion and contraction and produce a neat appearance. Design for strength and rigidity to suit loading and services, prevent undue stress to structural members and with provision for vertical adjustment after piping is erected.
- .4 Support piping independent of connected horizontal pipework.
- .5 Offset hanger pipe and structural attachments in such a manner that rod is vertical when piping is hot and is subject to tensile loading only.
- .6 Adjust hanger rods to equalize load.
- .7 Provide supplementary structural steelwork where structural bearings do not exist.
- .8 Where supporting from open web steel joists, attach supports to the approval of the structural engineer and comply with the following:
  - a. For all piping, attach supports to the top angle iron section of joists only.
  - b. For piping 3" (75mm) and larger running parallel to joists, provide supplementary steelwork so that piping is supported from a minimum of two joists.
  - c. Support from panel points only.
  - d. Hanger spacing shall not exceed 10'-0" (3.0m).

### **2.2 Hot Water Heating Piping**

- .1 Above Ground Metal Piping (Contractor to choose desired type):
  - a. Piping to NPS 6" (150mm) shall be ERW or seamless schedule 40, Grade B black steel complying with ASTM A53 / A53M.
  - b. Piping to NPS 3" (75mm) may be type L hard copper complying with ASTM B88.
  - c. Fittings shall be to the following as applicable:
    - i. Malleable iron screwed fittings, Class 150 to ASME B16.3.
    - ii. Steel pipe flanges and flanged fittings, Class 150 to ASME B16.5. Welding neck flanges shall be bored to match the same inside dimension as the attached pipe.

- iii. Steel butt-welding fittings to ASME B16.9 and with the same wall thickness as the attached pipe.
- iv. Malleable iron unions, Class 150 to ASME B16.3. Unions 2.5" (63mm) and larger shall be made with flanges.
- v. Sweat wrought copper or cast brass soldered fittings for Type 'L' copper piping.
- vi. All fittings shall be long radius type.
- d. Connections shall be to the following as applicable:
  - i. Piping NPS 2" (50mm) and under: screwed or soldered.
    - 1) For screwed piping connections, use teflon tape (pipe thread taper to ASME B2.1).
    - 2) Where copper piping is used joints shall be 95-5 hard solder.
  - ii. Piping NPS 2.5" (63mm) and over:
    - 1) Welded fittings to CSA W47.1
    - 2) Flanged:
      - I Flanges shall be flat or raised face as required to match the mating flange.
      - II Nuts and bolts shall be carbon steel square head machine bolts and heavy hex head nuts, to ASME B18.2.1 and ASME B18.2.2.
      - III Gaskets shall be to ASME B16.21, ASME B16.20 or ASME A21.11 and shall be spirally wound type 316L stainless steel with non-asbestos filler material and carbon steel outer ring, 0.125" (3.1mm) thick, conforming to the flange face on which they are used.

### 2.3 Pneumatic Tubing

- .1 In concealed locations, tubing shall be type L hard copper complete with soldered connections except that soft copper may be used for individual branches to thermostats.
- .2 In exposed locations, tubing shall be type L hard copper complete with soldered connections.

### 2.4 Valves

- .1 General
  - a. All valves shall have a pressure rating suitable for the system operating pressure.
  - b. Similar valves shall be of the same manufacturer.
  - c. All valves supplied for this project shall have a current and valid Canadian Registration Number for the Province of Ontario with TSSA. Suppliers shall provide a copy of the Statutory Declaration for valves, stamped, signed and dated by TSSA as validation of the CRN registration. This shall be provided along with the shop drawing submittal package.
  - d. Provide stem extensions / extended necks as required to suit insulation thickness.
  - e. Use only commercial grade valves meeting ANSI, ASTM, ASME and applicable MSS standards. Specification MSS-SP-80, MSS-SP-110, MSS-SP-70, 85, 71, MSS-SP-72, MSS-SP-67, API 602, API 598, API 609, API 600.
- .2 All valves shall be to the following or approved equal:

- a. Up to and including NPS 2" (50 mm), bronze valves as follows:
- i. Isolation:
    - 1) Ball valve complete with 2 piece forged brass body, stainless steel trim, blowout proof stem, PTFE seats, maintenance free double o-ring stem seals and full port design. Valves shall be pressure rated to 150 WSP / 600 WOG and conform to MSS-SP 110 and certified to CSA.
      - I Threaded valves: Kitz 68AMLL or approved equal.
      - II Soldered valves: Kitz 69AMLL or approved equal.
  - ii. Checks:
    - 1) Y-pattern swing check valve complete with cast bronze body, threaded cap and swing type disc integral seat. Valves shall be pressure rated to 125 WSP / 200 WOG.
      - I Threaded valves: Kitz 22 or approved equal
      - II Soldered valves: Kitz 23 or approved equal
    - 2) Spring loaded check valves
      - I Threaded valves: Kitz 36 or approved equal
      - II Soldered valves: Kitz 26 or approved equal
- b. NPS 2.5" (63 mm) and over, cast iron valves follows:
- i. Isolation:
    - 1) American Valve 4000 ball valve or approved equal of the floating ball design, capable of bi-directional shut-off, complete with cast iron body having interior / exterior epoxy coating, PTFE infused solid cast iron ball, blow-out proof type 304 stainless steel stem, PTFE seats / body seals, PTFE stem seal, locking handle (full open / closed position), full port design and flanged ends. The handle length shall be adjustable / removable. Valves shall be pressure rated to 125 WSP / 200 WOG.
    - 2) Kitz 6122-EL butterfly valve or approved equal, lugged type complete with ductile iron body, extended neck, ISO mounting pad, spline drive, molded seat liner (EPDM), aluminum bronze disc and locking lever operator. The valve shall be capable of bi-directional shut-off and shall be pressure rated to 200 WSP.
    - 3) Kitz 72 rising stem gate valve or approved equal, 860KPA (125psig) /200WOG Rating, Cast Iron Body to ASTM A126 Class B, Bronze Trim, OS &Y, Flanged.
    - 4) Kitz 75 non-rising stem gate valve or approved equal, 860KPA (125psig) /200WOG Rating, Cast Iron Body to ASTM A126 Class B, Bronze Trim, OS &Y, Flanged.
    - 5) Butterfly valve, 1380 KPA / 200WOG Rating. Butterfly valves shall be lugged type, Epoxy Coated Ductile iron body, with 2" extended neck to allow for insulation, stainless steel disc, PTFE (with EPDM backing) bonded seat, stainless steel stem with top and bottom bushings of dissimilar material. Valve shall have bubble tight shut-off to 200PSI when downstream flange is removed (Full dead-end service). Valves 150MM (6") and smaller shall have locking lever operator, valves 200MM (8") and larger shall have locking Manual Gear operator.
      - I MAS L-D-4-S-PE-LH (Lever) or approved equal.
      - II MAS L-D-4-S-PE-G (Gear) or approved equal.
  - ii. Checks:

- 1) Kitz 78 or approved equal class 125 swing check valve complete with cast iron body, bolted cover, swing type disc, flanged ends and bronze body seat / disc seat.
  - 2) Moygro W12A-16V wafer check valve or approved equal, 860KPA (125 psig)/200 WOG Rating, Cast Iron Body, 316 S.S Trim with Viton – A Seat Ring. Single Flapper.
  - 3) Mueller Steam Specialty 71AHH-3H double door check valve or approved equal, 860KPA, 125 psig/200 WOG, Class 125, Cast Iron Body, 316SS Trim & Buna Seat, Double Disc Assembly.
  - 4) Center guided silent check, 860KPA, 125 psig/200 WOG Class 125 Cast Iron Body, 316 SS Trim & Seat, Spring Loaded Center Guided Disc.
    - I Mueller Steam Specialty 101MAT or approved equal.
    - II Mueller Steam Specialty 105MAT (Globe Style) or approved equal.
- c. Circuit Balancing Valves: Victaulic / IMI TA Hydronics valves for precise flow measurement, balancing, and positive shut-off. Each valve to be variable orifice, wye pattern, globe style with self-sealing EPDM measurement points, EPDM seat, and digital handles with locking hidden tamper-proof setting. Valves shall be selected based on flow requirement. Suitable for operating temperatures to 248°F (120°C).
- i. ½" through 2": 400 psi, non-ferrous Ametal® DZR brass copper alloy body, EPDM O-ring seals. 4-turn digital readout handwheel for balancing, hidden memory feature with locking tamper-proof setting. Brass shall be ISO 6509 compliant. Victaulic / IMI TA Series 786H/787H/78KH. Install Victaulic Koil-Kits including Series 78Y strainer/ball valve/drain (or Series 78T ball valve/drain where strainer not required), with Series 78U union port fitting and coil hoses to complete terminal hookup.
  - ii. 2-1/2" through 16": 250 psi (flanged) or 350 psi (grooved) ASTM A536 ductile iron body, EPDM O-ring seals. Digital readout handwheel for balancing, hidden memory feature with locking tamper-proof setting. Bonnet, cone, and spindle shall be DZR brass (Ametal®) for ¾" through 6" sizes; bonnet and cone of ductile iron with Ametal® spindle for 8" through 12" sizes; and ductile iron bonnet with silicon-brass and gunmetal cone and Ametal® spindle for 14" and 16" sizes. Victaulic / IMI TA Series 788/789.
  - iii. Valves shall be installed as follows:
    - 1) With flow in the direction of the arrow on the valve body.
    - 2) At least five pipe diameters downstream from any fitting.
    - 3) At least 10 pipe diameters downstream from any pump.
    - 4) Two pipe diameters upstream of any fitting.
    - 5) With easy and unobstructed access to the valve handwheel and metering ports.
    - 6) To prevent sediment build-up in the metering ports.
- d. Drain valves:
- i. Two piece forged brass body, chrome plated ball, blowout proof stem, PTFE seats / seals, PP or brass cap and chain, full port design. Valves shall be pressure rated to 150 WSP / 600 WOG.
    - 1) Threaded / hose valves: Kitz 68C or approved equal.
    - 2) Soldered / hose valves: Kitz 69C or approved equal.
  - ii. Provide tamper proof vacuum breaker.

## 2.5 Expansion Joints and Guides

- .1 Expansion joints shall be as follows:
  - a. Pipe sizes 2 ½" (63 mm); Senior Flexonics Series H compensators or approved equal having the following characteristics:
    - i. Stroke: 1.75" (44mm) compression, 0.24" (6mm) extension.
    - ii. Maximum operating temperature: 750 deg. F. (400 deg. C.).
    - iii. Maximum working pressure: 200 Psig (1380 Kpa).
    - iv. Test pressure: 300 Psig (2070 Kpa).
    - v. Fittings: welded or threaded to suit piping.
    - vi. Bellows: stainless steel.
    - vii. Shroud and fittings: steel
  - b. Pipe sizes 3" (75 mm) and over; Flexonics ring controller stainless steel bellows type or approved equal, pressure and temperature rating to suit point of installation, length to be sized by manufacturer to suit pipe movement.
- .2 Provide compatible guides for all above units, Flexonics PGT series or approved equal. Locate the first guides within 4 pipe diameters on either side of the expansion joint and the second guides within 14 pipe diameters of the first guides.

## 2.6 Air Vents

- .1 Automatic air vents shall be Taco model 400 Hy-Vent or approved equal. Install air vents and collecting chambers at high points of heating system, where indicated on the drawings and in all locations where air can be trapped including unit heaters and heating coils. Provide stop cock to facilitate removal of vent without draining the heating system.
- .2 Heating units fed from supply and return mains or branches that are located below radiation units shall be vented with a manual air vent. Manual vents shall be Taco model 417 or approved equal.

## 2.7 Unit Heaters

- .1 Casing shall be constructed of minimum 18 gauge cold rolled steel and shall be complete with a factory mounted four way adjustable louvered diffuser and integral 3/8" (10mm) threaded hanger connections.
- .2 The copper-aluminum heating element shall consist of rippled aluminum fins mechanically bonded to 0.5 (13mm) copper tubes.
- .3 Headers shall be provided with steel MPT pipe connections located at the back of the unit.
- .4 The fan shall be aluminum blade type, factory dynamically and statically balanced, direct connected to the motor shaft and complete with a fan guard.
- .5 Motors shall incorporate sleeve bearings and automatic reset overload protection.
- .6 For model, accessories and performance requirements, refer to Equipment Schedule on the drawings.



## 2.8 Fan Coil Units

### .1 General

- a. Furnish and install Krueger® Model KBHD Blower Coil Units where indicated on the plans and specifications. Units shall be completely factory assembled and tested and shipped as one piece except where noted.
- b. All units shall be capable of meeting or exceeding the scheduled capacities for cooling, heating and air delivery. All unit dimensions for each model and size shall be considered maximums.
- c. All units shall be of "draw-thru" design with coils, fans, motor, and drain pan completely contained within the unit cabinet.
- d. Electric heat to be in the blow-thru configuration.
- e. Units shall be cETL listed in compliance with UL/ANSI Std. 1995.
- f. All unit coils shall meet or exceed the scheduled cooling and heating capacity, selected and rated in accordance with AHRI 410.

### .2 Construction

- a. All units shall be fabricated of minimum 18 gage galvanized steel, able to withstand a 125 hour salt spray test per ASTM B-117. Panels shall be die-formed "multibend" construction for optimum strength and rigidity.
- b. All exterior panels shall be single wall insulated with 1" thick fiberglass insulation, rated for a maximum air velocity of 5000 f.p.m.
- c. Insulation must meet all requirements of ASTM C1071 (including C665), UL181 for erosion, and carry a 25/50 rating for flame spread/smoke developed per ASTM E-84, UL723 and NFPA 90A. In addition to using adhesive complying with NFPA 90A, the insulation shall incorporate a secondary mechanical fastener attached to the unit casing wall. Adhesive as the only method of fastening the insulation to the casing is not acceptable.
- d. All access panels shall be fully insulated and attached with standard fasteners on at least two opposite sides. No single access panel shall be larger than 30" x 36" for safety and ease of handling. No coil or drain piping or electrical connections shall pass through any access panel. Each unit shall be furnished with a one-piece heavy gage.
- e. G90 steel or optional IAQ stainless steel drain pan with welded corner construction. Drain pan shall be insulated with minimum 1/8" closed cell foam. All units shall be provided with 9/16" diameter hanger rod holes in the top and bottom panels for "through-bolt" type suspension installation.
- f. All units shall have a minimum 1" duct collar on both the discharge and return.

### .3 Fan and Motor Assembly

- a. All units shall be furnished with double inlet forward curved centrifugal blowers statically and dynamically balanced for smooth operation. Blower wheels shall be mounted directly on the motor shaft. Belt driven blowers are not acceptable.
- b. Fan motors shall be ECM with thermal overload protection and a constant torque operation. RPM control shall not be acceptable.
- c. All motors to be installed, factory programmed and wired to the control panel.

- d. All motors shall be isolated, depending on motor size, via belly band or torsion flex mount to the blower housing.
  - e. All motor wiring is to be terminated in a junction box, external to the unit casing.
  - f. All motors to be operated multi-speed through a 0-10VDC signal.
- .4 Coils
- a. All unit coils shall be rated in accordance with AHRI 410.
  - b. All coils shall be 1/2" O.D. seamless copper tubes with collared aluminum fins. All tubes shall be mechanically expanded to provide an efficient bond between tube and fin. All water coils shall be provided with a manual air vent fitting to allow for coil venting. Valve core type vent fittings shall not be accepted.
  - c. All chilled water, hot water, and direct expansion (DX) coils shall have aluminum fins and 0.016" tube wall thickness.
  - d. All coils shall be hydrostatically tested with air under water at 450 PSIG minimum pressure and rated for a maximum of 450 PSIG working pressure at 200°F.
- .5 Filter Rack Assembly
- a. All units shall be furnished with a flat filter rack with hinged access on both sides designed to accept a 2" nominal standard sized filters. All units shall be provided with nominal 2" MERV8 filters factory installed.
- .6 Inlet Damper Section
- a. Where shown on the plans, the unit manufacturer shall furnish a fully insulated mixing box section.
  - b. The mixing box section shall include heavy gage formed steel blade dampers in a heavy gage steel frame with extruded vinyl blade seals and flexible metal jamb seals. Damper drive linkage shall be factory furnished and installed by the unit manufacturer. A field furnished and installed damper actuator can be mounted directly to the damper shaft.
- .7 Electrical Control
- a. The unit fan motor shall be completely factory wired to an external electrical enclosure. Each unit shall include fan control package with 24-volt control voltage. Each unit shall include a motor control board, motor circuit fusing, control circuit transformer and terminal strip for connection of field wiring. Motor control shall be through a 0-10 VDC provided from the BMS system.
  - b. Calibrated airflow curves shall be provided near the control box to aid in testing and balancing.
  - c. A main incoming power non-fused disconnect switch with lock-out tag-out ready feature shall be factory furnished and wired by the unit manufacturer for single point power connection.
- .8 Units shall be Krueger or approved equal. For model, accessories and performance requirements, refer to Equipment Schedule on the drawings.

## 2.9 Piping Installation Requirements

- .1 Piping shall be installed according to good commercial standards and approximately as follows:
  - a. All piping running vertically shall run concealed in wall construction / furred enclosures unless noted otherwise on the drawings. Under no condition is any piping to be installed in concealed spaces in outside walls.
  - b. Use unions or flanged joints in sufficient quantities to facilitate removal of equipment without removal of long lengths of pipe.
  - c. Install eccentric reducers in horizontal piping to permit drainage and eliminate air pockets.
  - d. Where pipe sizes differ from connection sizes of equipment, install reducing fittings close to equipment. Reducing bushings are not permitted.
  - e. All valves and other pipe accessories shall match the associated pipe size unless noted otherwise.
  - f. Cut ends of pipes square, ream, clean scale / dirt and assemble without binding.
  - g. Install copper tubing so that it is not in contact with dissimilar metal and will not be kinked or collapsed.
  - h. Plug or cap pipe and fittings to keep out debris during construction.
  - i. All piping shall be laid straight and in true alignment to the slopes of the pipe, as indicated on the drawings and / or as directed.
  - j. Install piping free from strains and with proper allowance and off-sets for thermal expansion and contraction. Provide all branches running from risers or piping mains with three elbow swing joints at minimum 14" (350mm) spacing.
  - k. Slope piping up in direction of flow at a minimum rate of 1/20" per foot (0.43mm/100mm) length and provide drain at low points. The entire hot water heating system shall be capable of being drained.
  - l. Take heating branches off piping mains at 45 degrees looking up when feeding above and 45 degrees looking down when feeding below.
  - m. Provide all piping connections to all mechanical equipment, etc. with valves and unions located so that removal of equipment is possible without disconnecting more than a minimum amount of pipework, shutting down other pieces of equipment or draining the entire system.
  - n. Install a minimum of 14" (350mm) straight run piping between pipe elbows, valves or other fittings unless noted otherwise on the drawings.
  - o. Install check valves in horizontal or vertical upflow piping only.
  - p. Provide clearance for maintenance of equipment and valves.

## 2.10 Draining and Refilling the Heating Water System

- .1 This Contractor shall be responsible for draining and refilling the heating system to permit revisions as noted on the drawings.
- .2 Equipment, chemicals and all required supervision for chemical cleaning and final treatment shall be provided by Aquarian Chemicals only (phone # (905) 825-3711. Alternative suppliers will not be permitted.
- .3 All new and affected existing piping system (mains and branch piping) shall be flushed and cleaned as follows, in the specified order:

- a. Flush using raw water to ensure removal of heavy debris and excessive oil or dirt.
  - b. During flushing, maintain all isolating and control valves in the open position.
  - c. Do not flush piping through equipment which could be damaged by pipe debris (coils, boilers, radiant heaters, etc.). Provide necessary bypass piping.
  - d. All strainers shall then be cleaned.
  - e. Clean with neutral pH cleaner or approved equal. The cleaner shall be introduced into system at a dosage of 2 gallons per 100 gallons (9.0 litres per 455 litres) of water in the system and circulated for 24 hours at ambient temperature.
  - f. The complete system shall then be drained as quickly as possible using all available drain valves.
  - g. Immediately refilled with fresh water and circulate for a minimum of 60 minutes.
  - h. The complete system shall then be drained and refilled. If any foaminess or discoloration is still present, the system will require repeated draining and refilling. Ensure that all residual cleaner has been removed to the approval of the chemical treatment manufacturer.
  - i. Following cleaning / flushing procedures, clean strainers and immediately fill system.
  - j. Make all necessary provisions in the piping system for the introduction of the cleaning chemicals.
- .4 Chemically treat the heating water according to the existing chemical treatment manufacturer's recommendations. All chemicals shall be supplied by Owner and installed by This Contractor.
- .5 Adjust PH levels according to water treatment supplier recommendations so that damage does not occur to the aluminium boilers.

#### 2.11 Testing and Inspection

- .1 Test hot water heating piping at 1.5 times the system operating pressure or 125 Psig (860 Kpa), whichever is greater for a minimum 4 hour period or as may be necessary to determine if there is leakage. Repair all leaks to the Consultants approval.
- .2 All leaks shall be repaired by remaking the joint. After piping systems have been tested and repaired, repeat tests.
- .3 All equipment / devices which may be damaged by test pressures shall be isolated during testing procedures.
- .4 Lines containing check valves shall have the source of test pressure located on the upstream side.

#### 2.12 Balancing of the Hot Water Heating System

- .1 All balancing shall be performed under the HVAC contract.

### **3. HEATING, VENTILATING AND AIR CONDITIONING**

#### 3.1 Ductwork

- .1 All ductwork shall be G-60 galvanized steel unless noted otherwise, in accordance with ASTM A-653 and A-924. Thickness and fabrication shall be to ASHRAE and SMACNA standards.

- .2 Fittings and joints shall be fabricated and installed to ASHRAE and SMACNA standards.
- .3 All exposed above ground circular ductwork shall be spiral type as follows:
  - a. Ductwork shall be constructed of Satin Coat steel.
  - b. Duct and fittings shall be constructed in accordance with the latest SMACNA HVAC Duct Construction Standard.
  - c. Straight Duct:
    - i. The straight duct shall be constructed with an interlocking 4-ply helical seam that runs the complete length of the duct. The grooved seam shall be located entirely on the outside, resulting in a smooth interior for a low friction loss.
    - ii. The straight duct shall be smooth type (corrugations / grooves to increase rigidity are not required).
  - d. Fittings:
    - i. Fittings shall be standing seam or pressed / stamped type.
    - ii. Fittings shall be '1.5D' type unless not possible due to space restrictions.
  - e. Straight duct sections and fittings shall utilize slip-joint connections. Provide couplings where joining straight duct sections. .
- .4 Non-metallic flexible ductwork shall be Thermaflex S-LP or approved equal, non-collapsible woven and coated fibre glass fabric permanently bonded to a coated spring steel wire helix. Where flexible ductwork is connected to thermally insulated rigid ductwork, flexible ductwork shall be thermally insulated type, Thermaflex G-KM or approved equal. Flame and smoke developed ratings not to exceed 25 and 50 respectively. Ducts shall comply with ULC, NFPA and SMACNA standards.
- .5 Maximum length of flexible ductwork shall be 8'-0" (2400mm).
- .6 All duct runnouts shall have a diameter the same size as the diffuser neck size unless noted otherwise.
- .7 All rectangular supply / return / exhaust ducts shall connect to main ducts complete with 45 degree entry. This shall include branches serving grilles mounted directly to the duct except that for grilles mounted to exposed spiral duct work a square entry is permitted.
- .8 All supply / return / exhaust elbow fittings shall have a centreline radius equal to 1.5 times the duct width for rectangular ducts or 1.5 times the diameter for round ducts. Where absolutely not possible due to space constraints, a centreline radius of 1 times the width (or diameter) shall be permitted or square elbows complete with turning vanes shall be permitted.
- .9 All supply, exhaust and return air ductwork shall be complete with sealed joints as follows:
  - a. Supply and exhaust air ductwork located in conditioned spaces within the building shall be Seal Class C as defined in SMACNA standards (transverse joints / connections made airtight with sealing compound, longitudinal seams unsealed).
  - b. Supply, return and exhaust ductwork located outside the building envelope or located in unconditioned spaces within the building shall be Seal Class A as defined in SMACNA standards (transverse joints / connections, longitudinal seams and duct wall penetrations made airtight with sealing compound).

- c. Weld booth exhaust air ductwork shall be Seal Class A as defined in SMACNA standards (transverse joints / connections, longitudinal seams and duct wall penetrations made airtight with sealing compound).
  - d. Exposed ductwork shall be neatly sealed to the approval of the Consultant, without excess caulking.
  - e. Unconditioned spaces are those which are not heated or cooled.
  - f. Return air ductwork is not required to be sealed.
- .10 All exposed ductwork located outside of Mechanical / Electrical / Janitor / Storage Rooms shall be manufactured from satin coat steel suitable for painting unless otherwise approved by the Painting Contractor.
- .11 Provide suitable sheet metal angle collar for ductwork running exposed through walls, ceilings or floors. Install collar tight against the wall, ceiling or floor and duct, sized to cover opening.

### 3.2 Turning Vanes

- .1 Factory or shop fabricated single or double thickness to recommendations of SMACNA.

### 3.3 Supports

- .1 All ducts shall be adequately supported. Maximum size to be supported by a strap hanger shall be 36" (900mm) wide. All other ducts shall be supported by steel angles complete with threaded rods, locking nuts and washers. Threaded rods shall be sized according to the recommendations of Grinnell to suit the application. Hanger spacing shall comply with SMACNA standards.
- .2 Ducts cannot in any location be supported from the furring or ceiling construction. Also, ducts having areas greater than 1.0 sq. ft. (0.1 sq. m.) cannot in any location be supported from the metal floor / roof deck. Smaller ducts which are permitted to be supported from the metal floor / roof deck shall be fastened to the sides (not bottom) of the flutes and shall be attached with a minimum #10 size screw.
- .3 All pipe and equipment supports shall be as follows:
- a. Supports shall be Grinnell or approved equal of spacing and type as recommended by manufacturer, in accordance with Code requirements and in accordance with good commercial standards.
  - b. Provide supports to secure pipes / equipment, prevent pipe vibration, maintain required grading, allow for expansion and contraction and produce a neat appearance. Design for strength and rigidity to suit loading and services, prevent undue stress to structural members and with provision for vertical adjustment after piping is erected.
  - c. Anchor / support risers so that weight is not transferred to connected horizontal piping.
  - d. Offset hanger pipe and structural attachments in such a manner that rod is vertical when piping is at operating temperature and is subject to tensile loading only.
  - e. Adjust hanger rods to equalize load.
  - f. Provide supplementary structural steelwork where structural bearings do not exist

- g. Where supporting from open web steel joists, attach supports to the approval of the structural engineer and comply with the following:
  - i. Attach supports to the top angle iron section of joists only.
  - ii. Support from panel points only.
- .4 Supports for exposed spiral ductwork shall consist of a steel rod centered over the duct and attached to a continuous band around the duct (sheet metal strips will not be permitted in place of steel rod support).
- .5 Supports for exposed spiral ductwork shall be as detailed on the drawings or alternate method approved by the Consultant. Where desired by the Contractor, the spiral ductwork may be supported using the Gripple Hangfast system as follows:
  - a. The system manufacturer shall supply the locking mechanism (gripple) and the wire rope. Rope not supplied by the manufacturer shall not be used with the locking mechanism.
  - b. The locking mechanism shall be fully adjustable, manually in an ascending movement and descending by the way of a setting key.
  - c. The release mechanism shall not be accessible and will only be operable by the use of a key system.
  - d. The wire rope shall be galvanized steel wire manufactured in accordance to BS 302 (1987). The rope shall have a ferrule loop at one end.
  - e. The wire rope shall not have any paint or other coating applied to it. This specifically includes lubricant.
  - f. Manufacturer's weight loading recommendations shall be adhered to for selecting system components.
  - g. The system shall conform and be approved by all local, Provincial and Federal authorities.
  - h. The wire rope may be looped directly around the bottom cord of the roof structural members or other appropriate supports.

### 3.4 Roof Curbs

- .1 All curbs for roof mounted exhaust fans, rooftop units, relief caps, etc. shall be supplied and installed by the Mechanical Contractor.
- .2 Roof curbs shall be galvanized steel with wood nailer strip, turndown flange and shall be capable of supporting the entire unit weight. Curbs may be bolted together on site where required for ease of transporting to site.
- .3 Provide a closed cell curb gasket with adhesive on one side to seal between the ductwork / roof mounted equipment and the top of curb.
- .4 Suitably secure curbs to the roof deck and level according to manufacturer's recommendations. The sides of curbs shall be insulated on the exterior with insulation of the same type and having the same thickness as the new / existing roof insulation.

### 3.5 Duct Access Doors

- .1 Provide duct mounted access doors to service all mechanical equipment requiring maintenance access (including fire dampers, motorized dampers, heating coils, etc.). Provide doors on one or both sides of device as required to permit full service / cleaning. Doors shall be Nailor-Hart series 0800 or approved equal, insulated sandwich construction complete with sheet metal angle frame, 1" (25mm) thick insulation, gaskets and camlocks. Sizing to manufacturer's recommendations to suit application.

### 3.6 Duct Sealant

- .1 Interior duct sealant shall be Bakor Duck-Seal or approved equal having a maximum flame and smoke rating of 25 and 50 respectively. Exterior duct sealant shall be Bakor 530-09 or approved equal having a maximum flame and smoke rating of 25 and 50 respectively.

### 3.7 Refrigeration Piping

- .1 The design, construction, testing and stamping of every pressure vessel and associated piping and the registration of fittings shall conform to all requirements of CSA B52. All applicable requirements relating to welding / brazing procedures, quality control procedures and other related requirements must be followed. All pressure retaining components within the scope of CSA Standard B51 shall be constructed to a design that is registered as a pressure vessel, a fitting or a piping system.
- .2 For this project, the refrigeration system(s) will not require system registration with TSSA.
- .3 Refrigerant piping and fittings shall be registered in accordance with CSA Standard B51. If applicable, they shall be listed either individually or as part of refrigeration equipment by an approved testing laboratory or shall comply with ANSI / ASME B31.5. Piping shall also comply with the following:
  - a. Unprotected hard-drawn copper tubing shall conform to ASTM B88, type L.
  - b. Soft copper tubing will not be permitted.
- .4 All piping shall be supplied clean and dehydrated.
- .5 Connections:
  - a. Use manufacturer's flared connections (where applicable) in accordance with manufacturer's installation instructions.
  - b. Do not use flux when brazing refrigeration piping. Use phosphor copper brazing filler metal (B-Cu93P-710/795: ISO 3677) which does not require flux.
  - c. A pure dry nitrogen flow of 1-3 cubic feet / minute (0.5-1.5 l/s) shall be introduced into the pipe during brazing to displace air. Control the flow using a suitable metering device.
- .6 All refrigerant lines shall be sized, pitched and installed according to manufacturer's recommendations and as indicated on the drawings. Ensure that oil is properly returned to the compressor. All pipe sizes indicated on the drawings shall be verified and adjusted on site according to manufacturer's recommendations and to suit the final installed pipe lengths.



- .7 Systems shall be complete with refrigerant metering device / expansion valve, filter drier, sight glass, isolation valves, purge valves, etc. as required for the proper operation and maintenance of the system. All accessories shall be of adequate capacity and of suitable type for the service required.
- .8 Pitch horizontal hot gas piping at a minimum rate of 0.5" per 10'-0" (42mm per 10.0m) so that gravity will aid in moving oil in the direction of refrigerant / oil flow.
- .9 Stop valves used with soft, annealed copper tubing or hard-drawn copper tubing 7/8" (22mm)OD or smaller shall be securely mounted, independent of tubing fastenings or supports.
- .10 All required refrigerant in excess of the charge shipped with the mechanical equipment shall be supplied and installed by the Contractor.
- .11 Do not open valves isolating equipment until all piping is pressure tested and evacuated.
- .12 The high and low sides of all refrigeration piping shall be tested and proven tight at not less than the lower of the design pressure given in CSA B51 or the setting of the pressure-relief device protecting the high and low sides of the system respectively. In testing systems using non-positive displacement compressors, the entire system shall be considered at the low-side pressure for test purposes. Repair all leaks by remaking the connection and re-test.
- .13 The system shall be pressure tested to the following minimum standards:
  - a. Pressurize the complete system using Nitrogen to 45 Psig (310 Kpa) and hold for a minimum of 3 minutes.
  - b. Pressurize the complete system using Nitrogen to 220 Psig (1515 Kpa) and hold for a minimum of 3 minutes.
  - c. Pressurize the complete system using Nitrogen to 450 Psig (3100 Kpa) and hold for a minimum of 24 hours.
- .14 Evacuate all system components as follows:
  - a. Evacuate the line set and indoor unit to an absolute pressure of 23,000 microns.
  - b. Break the vacuum with dry nitrogen set for a discharge pressure of 150 Psig (1035 Kpa).
  - c. Release the dry nitrogen from the line set and the indoor unit.
  - d. Evacuate the line set and indoor unit until the absolute pressure does not rise above 1000 microns within a 7 minute period after shutting off the vacuum pump and closing the test manifold gauge valves.
  - e. When the absolute pressure requirement has been met, break the vacuum with refrigerant and charge the system to manufacturer's recommendations.
  - f. Use a vacuum gauge with is capable of accurately measuring down to 50 microns.
- .15 Insulation for all suction and hot gas piping shall be 0.5" (13mm) Armacell AP Armaflex Tube unslit flexible elastomeric cellular pipe insulation or approved equal with a "K" factor of 0.27 Btu-in/hr.-sq.ft.-deg.F (0.039 W/m.-deg.C) at a mean temperature of 75 deg. F. (24 deg. C.). All insulation and associated components shall have maximum flame spread and smoke developed ratings of 25 and 50 respectively. Apply according to manufacturer's recommendations and approximately as follows:

- a. All butt joints shall be sealed using Armaflex 520 adhesive. Both surfaces to be joined shall be completely coated with adhesive and butted firmly together.
  - b. All exterior insulation shall be protected as per Insulation section. Armstrong Armaflex WB finish is not acceptable.
  - c. Apply using slip-on method unless not possible due to site conditions. Where required to use slit type insulation, seal all joints using Armaflex 520 adhesive.
  - d. Insulation shall be neatly cut to fit snugly around obstacles. Seal all joints using Armaflex 520 adhesive.
  - e. Comply with manufacturer's recommendations regarding required ambient temperatures.
- .16 Each refrigeration system shall be provided with a permanent sign securely attached, readily accessible and legible indicating the following:
- a. Name and address of the installer
  - b. Refrigerant identification
  - c. Lubricant identity and amount
  - d. Total weight of refrigerant required for normal operations
  - e. Field test pressures applied
  - f. Refrigeration capacity at design or nominal condition
  - g. Prime movers rating in HP (KW) or full load current and voltage.
  - h. In addition to these requirements, for systems containing more than 100 lb. (45 kg) of refrigerant, provide lamacoid nameplates having letters not less than 0.5" (13mm) in height designating the following items:
    - i. Main electrical disconnect switch(es).
    - ii. Any remote control switch(es).
    - iii. Any pressure limiting device(s).
    - iv. Each pressure vessel.
    - v. Main shut-off to each vessel.
    - vi. Refrigerant piping indicating whether it is at the high-side or low-side pressure and whether it is normally in the liquid or vapour state.
- .17 Refrigeration pipe supports shall be resilient type, Unistrut Cush-A-Clamp or approved equal.
- .18 Do not allow refrigeration piping to be in direct contact with the building structure.
- .19 Provide one year full guarantee on the complete refrigeration system including all components, refrigerants and oils. Provide five year warranty on compressor.

### 3.8 Condensate Drain Piping Within Building

- .1 For cooling coil condensate piping, CPVC Schedule 40 pipe with socket fittings.
- .2 Solvent weld all socket fittings according to manufacturer's recommendations
- .3 Provide minimum 4" (100mm) trap seal for cooling coils or according to manufacturer's recommendations.
- .4 Install all drains at minimum 2% slope unless noted otherwise on the drawings.
- .5 Pipe to discharge to funnel floor drain.

### 3.9 Rooftop Unit Condensate Drain Piping

- .1 Schedule 40 galvanized steel pipe complete with threaded connections. Provide minimum 4" (100mm) trap seal.
- .2 Provide open standpipe on downstream side of trap according to the rooftop unit manufacturer's recommendations (to permit free flow of condensate and cleaning of trap).

### 3.10 Flexible Duct Connections

- .1 Unless noted otherwise, duct connections to rooftop units and exhaust fans shall be made using flexible duct connections, Duro-Dyne "Super Metal-Fab" or approved equal having the following features:
  - a. 24 gauge (0.7mm) galvanized steel frame.
  - b. Each frame shall be 3" (75mm) wide and the fabric shall be 6" (150mm) wide.
  - c. Seams: Grip Loc
  - d. Fabric: woven fiberglass complete with a neoprene coating, -40 to 200 deg. F. (-40 to 82 deg. C.) continuous operating temperatures.
  - e. Suitable for pressures from -10" wc. to 15" wc. (-2.5 to 3.7 Kpa) with no tearing or visible separation.
  - f. Airtight and waterproof.
  - g. Designed to meet NFPA 701, 90A and 90B.

### 3.11 Fire Dampers

- .1 Fire dampers shall be Nailor series D0100 or approved equal (series D0500 for ratings of 3 hrs. or more), curtain type fire dampers **classified for use in Dynamic Air Systems (systems which remain in operation in the event of a fire) as well as suitable for use in Static Air Systems (systems which shut down in the event of a fire)**. Dampers shall be as follows:
  - i. Dampers shall meet the requirements of NFPA 90A and shall be manufactured, tested and labeled in accordance with UL 555 Safety Standard for Fire Dampers - Sixth Edition, June 1999, including Dynamic Closure Test.
  - ii. Dampers shall be classified for dynamic closure against an airflow velocity of 2000 fpm (610 mpm) at 4" (100mm) static pressure differential across closed damper.
  - iii. Each fire damper shall bear a UL 1.5 hour fire resistance rating label in addition to label verifying the airflow and closure pressure ratings as established by the Dynamic Closure Test. Each fire damper shall also be marked with the words For use in dynamic systems. Dampers marked For use in static systems only are not acceptable.
  - iv. Each fire damper shall be complete with a 165 deg. F. (74 deg. C.) UL Listed fusible link.
  - v. Each damper shall include a steel sleeve of appropriate length / gauge and retaining angles on both sides of penetration, field supplied and installed by the Mechanical Contractor.
  - vi. Fire dampers shall be labelled for fire rating to suit building construction at point of installation.

- vii. Except as otherwise noted, fire damper configuration shall be type A or B for rectangular ductwork (type shall be selected by the Contractor to suit installation) and type CR for round ductwork. Type A fire dampers will not be permitted to be installed in ducts having a minimum dimension of 8" (200mm) or less.
- .2 Where duct sizes exceed available single section damper sizes for D0100 dampers, Nailor series D1200 or approved equal (series D1200-3 for ratings of 3.0 hours or more) airfoil blade type fire dampers may be used. Dampers shall be as follows:
- i. The frame shall be constructed of 16 ga. (1.6mm) galvanized steel hat channel with mitered corners reinforced with die-formed corner gussets for strength.
  - ii. Blades shall be 14 ga. (2.0mm) galvanized steel formed double skin, airfoil design, on 5.5" (138mm) centers. Dampers shall be of opposed blade configuration with an interlocking blade design that provides complete flame and smoke seal under fire conditions at an elevated temperature of 2000 deg. F. (1093 deg. C.) when in the closed position.
  - iii. Blade axles shall be plated steel, double bolted at each end of blade to ensure positive locking connection. Hex or square friction-fit, or press-fit axles are not acceptable.
  - iv. Bearings shall be self-lubricating oilite bronze type.
  - v. Blade linkage shall be zero-maintenance, concealed in frame, out of the airstream.
  - vi. Dampers shall meet the requirements of NFPA 90A and shall be manufactured, tested and labeled in accordance with UL 555 Safety Standard for Fire Dampers - Sixth Edition, June 1999, including Dynamic Closure Test.
  - vii. Dampers shall be classified for dynamic closure against an airflow velocity of 2000 fpm (610 mpm) at 4" (100mm) static pressure differential across closed damper.
  - viii. Each fire damper shall bear a UL 1.5 hour fire resistance rating label (3.0 hour label for D1200-3 dampers) in addition to label verifying the airflow and closure pressure ratings as established by the Dynamic Closure Test. Each fire damper shall also be marked with the works For use in dynamic systems. Dampers marked For use in static systems only are not acceptable.
  - ix. Each fire damper shall be complete with a 165 deg. F. (74 deg. C.) UL Listed fusible link that will cause the damper to close and lock in the closed position by means of an over-center / knee lock linkage for assured closure.
  - x. Each damper shall be supplied with an internal manual quadrant(s) for setting and locking of blades in the desired position.
  - xi. Each damper shall include a steel sleeve of appropriate length / gauge and retaining angles on both sides of penetration, field supplied and installed by the Mechanical Contractor.
  - xii. Fire dampers shall be labeled for fire rating to suit building construction at point of installation.
  - xiii. Fire damper configuration shall be type A or B for rectangular ductwork (type shall be selected by the Contractor to suit installation) and type C for round ductwork.

- .3 Where fire dampers are installed at grilles, dampers shall be Nailor series D0110G or approved equal, dynamic type.
- .4 Install all dampers according to Code requirements and manufacturer's installation instructions.

### 3.12 Combination Fire / Smoke Dampers

- .1 Combination fire/smoke dampers shall be Nailor series 1270 series or approved equal constructed as follows:
  - a. Frame shall be constructed of 16 gauge galvanized steel hat channel with mitered corners reinforced with die-formed corner gussets for strength.
  - b. Blades shall be of triple-vee design, 16 gauge galvanized steel, on 5.5" (138mm) centers and shall be parallel configuration.
  - c. Blade axles shall be 0.5" (13mm) diameter plated steel, double bolted at each end of blade to ensure positive locking connection. Hex or square friction-fit or press-fit axles are not acceptable.
  - d. Bearings shall be self-lubricating oilite bronze type.
  - e. Blade linkage shall be zero-maintenance, concealed in frame, out of airstream.
  - f. Jamb seals shall be compression type stainless steel. Blade seals shall be silicone.
- .2 Dampers shall meet the requirements of NFPA 90A, 92A and 92B and shall be classified by UL and labeled as a 1.5 hour fire damper under UL 555 and as a Class II Leakage Rated smoke damper under UL555S at an elevated temperature of 350 deg. F. (177 deg. C.).
- .3 Dampers shall be qualified for use in dynamic or static Smoke Control Systems.
- .4 Dampers shall be supplied with factory installed sleeves (optional field supplied sleeves may be supplied where desired by the Contractor) of minimum 16" (400mm) length, to be field verified by Contractor to suit the wall thickness. Sleeves shall be caulked to UL requirements and shall be 20 gauge through 84" (2100mm) wide, and 18 gauge above 84" (2100mm) wide. Provide type A, B or C sleeve to suit installation.
- .5 A Honeywell or approved equal model ML4115, 120 volt actuator (power open, spring close) shall be installed by the damper manufacturer in the factory and shall have been tested and classified under UL555S with the damper at an elevated temperature of 350 deg. F. (177 deg. C.). Actuators shall incorporate an OEM internal spring return mechanism. External after-market spring mechanisms are not acceptable. Damper and actuator assembly shall be factory cycled a minimum of three times to ensure correct operation.
- .6 Each damper shall be equipped with a UL Classified heat responsive device that will cause the damper to close in a controlled manner and lock in a closed position by means of an over center / knee lock linkage, when the duct temperature reaches the maximum degradation temperature of the damper / actuator assembly as required by UL555S. Closure devices that cause instantaneous closure are not acceptable.

### 3.13 Motorized Dampers

- .1 For dampers not exposed to outdoor conditions, Tamco series 1000 or approved equal, opposed blade action having the following features:
  - a. Extruded aluminum damper frame shall be 4" (100mm) deep and not less than .080" (2.03mm) thickness.
  - b. Blades shall be of extruded aluminum profiles and complete with EPDM gaskets secured in an integral slot within the extrusion.
  - c. Frame seals shall be of extruded TPE.
  - d. Linkage hardware shall be installed in the frame side and shall be constructed of aluminum and corrosion-resistant, zinc-plated steel, complete with cup-point trunnion screws for slip-proof grip.
  - e. Bearings shall be composed of a celcon inner bearing fixed to a 7/16" (11.1mm) aluminum hexagon blade pin, rotating within a polycarbonate outer bearing inserted in the frame.
  - f. Based on a 48"x48" (1200x1200mm) damper, air leakage shall not exceed 10.3 CFM/sq. ft. (52 L/S/ sq. m.) against 4" (1 Kpa) w.c. differential static pressure.
  - g. The pressure drop through a fully open damper shall not exceed .02" (.004 Kpa) w.c. at 1000 FPM (5.08 m/s).
  - h. Dampers shall be made to the sizes indicated on the drawings without blanking off free area.
  - i. Mounting type shall be flanged to duct, installed in duct or square to round type as applicable.
  
- .2 For dampers exposed to outdoor conditions, Tamco series 9000 BF or approved equal, opposed blade action having the following features:
  - i. Extruded aluminum damper frame shall be 4" (100mm) deep, not less than .080" (2.03mm) thickness, with mounting flanges on both sides of the frame.
  - ii. The entire frame shall be thermally broken by means of polyurethane resin pockets complete with thermal cuts.
  - iii. Blades shall be of extruded aluminum profiles, internally insulated with expanded polyurethane foam and shall be thermally broken. The complete blade shall have an insulating factor of R-2.29 and a temperature index of 55.
  - iv. Blade and frame seals shall be of extruded silicone, for reduced air leakage at colder temperatures. Blade and frame seals shall be secured in an integral slot within the aluminum extrusions and shall be mechanically fastened to prevent shrinkage and movement over the life of the damper.
  - v. Bearings shall be composed of a celcon inner bearing fixed to a 7/16" (11.1mm) aluminum hexagon blade pivot pin, rotating within a polycarbonate outer bearing inserted in the frame.
  - vi. An adjustable 7/16" (11.1mm) hexagonal drive rod, u-bolt fastener, and hexagonal retaining nuts shall be zinc-plated steel.
  - vii. Aluminum and corrosion-resistant zinc plated steel linkage hardware shall be installed in the frame side, complete with cup-point trunnion screws for a slip-proof grip.
  - viii. Dampers shall be designed for operation in temperatures ranging from -40 deg. F. (-40 deg. C.) to 212 deg. F. (100 deg. C.).
  - ix. Dampers shall be leakage Class 1A at 1" w.c. (0.25 Kpa) static pressure differential. Standard air leakage data shall be certified under the AMCA Certified Ratings Program.

- x. Dampers shall be opposed blade action.
- xi. Dampers shall be made to the sizes indicated on the drawings without blanking off free area. Mounting type shall be "flanged to duct" only.
- xii. Dampers shall be installed according to the manufacturers installation guidelines.

### 3.14 Manual Dampers

- .1 For spin-in collars, single blade butterfly dampers shall be of same material as duct. Metal construction and damper configuration to recommendations of SMACNA. Balancing dampers shall have handle and hand locking quadrant. Where dampers are installed in thermally insulated ductwork, provide 2" (950mm) stand-off bracket for hand quadrant.
- .2 For round ductwork 20" (500mm) diameter and less, provide single blade butterfly dampers, Nailor model 1890 or approved equal. Dampers shall be constructed and configured to the recommendations of SMACNA. Provide the following construction features:
  - i. 22 gauge (0.86mm) galvanized steel frame with roll-formed stiffening beads up to 12" (300mm) diameter, 20 gauge (0.91mm) over 12" (300mm) diameter.
  - ii. 22 gauge (0.86mm) galvanized steel blade up to 12" (300mm) diameter, 20 gauge (1.0mm) over 12" (300mm) diameter.
  - iii. Blade axle / drive shaft shall be 0.25" (6mm) square plated steel.
  - iv. Hand locking quadrant.
  - v. Where dampers are installed in thermally insulated ductwork, provide 2" (950mm) stand-off bracket for hand quadrant.
- .3 For round ductwork up to 24" (600mm) diameter, provide single blade butterfly dampers, Nailor model 1090-ALS or approved equal, aluminum construction complete with stainless steel hardware. Dampers shall be constructed and configured to the recommendations of SMACNA. Provide the following construction features:
  - i. Aluminum frame with roll-formed stiffening beads.
  - ii. Two aluminum blades laminated together, complete with open / close end stops, 90 degree rotation.
  - iii. Stainless steel drive shaft and axle. The axle shall extend approximately 6" (150mm) beyond the frame.
  - iv. Cross-linked polyethylene blade seals.
  - v. Hand locking quadrant.
  - vi.
- .4 For rectangular ductwork, provide single blade dampers for ducts sizes up to 24" x 12" (600x300mm), Nailor model 1870 or approved equal. Dampers shall be constructed and configured to the recommendations of SMACNA. Provide the following construction features:
  - i. 18 gauge (1.3mm) galvanized steel frame with structural ribs for maximum strength and low profile for maximum free area.
  - ii. 20 gauge (1.0mm) galvanized steel blades up to 24"x12" (600x300mm) complete with structural ribs for extra strength.
  - iii. Blades shafts shall be 0.25" (6mm) square plated steel complete with a hand locking quadrant.

- iv. Where dampers are installed in thermally insulated ductwork, provide 2" (50mm) stand-off bracket for hand quadrant.
  - v. For dampers installed in aluminum ductwork, provide aluminum frame and blades with stainless steel linkage, bearings, axles and related hardware.
- .5 For rectangular ductwork, provide multi-blade where duct sizes exceed 24" x 12" (600x300mm), Nailor model 1820 or approved equal. Dampers shall be constructed and configured to the recommendations of SMACNA. Provide the following construction features:
- i. 16 gauge (1.6mm) galvanized steel hat channel frame with die-formed corner gussets.
  - ii. 16 gauge (1.6mm) galvanized steel vee groove design blades on maximum 6" (150mm) centers in opposed configuration.
  - iii. Blade axles shall be 0.5" (13mm) diameter plated steel, double bolted to blades.
  - iv. Bearings shall be 0.5" (13mm) Celcon molded synthetic type
  - v. Plated steel blade linkage shall be concealed type, totally enclosed within the frame and out of airstream.
  - vi. Provide 6" (150mm) long by 0.5" (13mm) diameter lock-on drive shaft on each damper section complete with a hand locking quadrant.
  - vii. Where dampers are installed in thermally insulated ductwork, provide 2" (50mm) stand-off bracket for hand quadrant.
  - viii. For dampers installed in aluminum ductwork, provide stainless steel construction.
- .6 Where manual balancing dampers are installed in exposed locations, the damper operator shall be installed on the top of the duct.

### 3.15 Grilles and Diffusers

- .1 Krueger or approved equal. Refer to Diffuser and Grille Schedule on drawings for model and type.
- .2 Provide restraining chain to prevent the inner cone from falling from the diffuser.
- .3 All aluminum grilles shall be fastened with stainless steel screws.

### 3.16 Duct Acoustic Insulation

- .1 Johns Manville Linacoustic RC or approved equal flexible duct liner made with glass fibers bonded with a thermosetting resin. The airstream surface shall be protected with a Permacote acrylic coating with a flexible glass cloth reinforcement. A factory applied coating shall be applied to the edges of the liner core.
- .2 Unless noted otherwise on the drawings, provide 0.5" (13mm) thickness having an R value of 2.2 hr.-sq.ft.-deg.F / Btu (0.38 sq.m.-deg.C/W) for all ductwork where indicated on the drawings. NOTE: WHERE ACOUSTIC LINING IS INSTALLED, SIZE OF DUCTWORK IS ACTUAL OUTSIDE DIMENSION OF DUCT.



- .3 All portions of duct designated to receive duct liner shall be completely covered with liner. Transverse joints shall be neatly butted and there shall be no interruptions or gaps. The liner surface designed to be exposed shall face the air stream. Duct liner shall be adhered to the sheet metal with 100% coverage of adhesive and all exposed leading edges and all transverse joints coated with adhesive. The liner shall be additionally secured with weld-on pins which shall compress the duct liner sufficiently to hold it firmly in place.
- .4 Duct liner shall be cut to assure overlapped and compressed longitudinal corner joints. For velocities to 2,500 ft./min. (762 m/min.) the weld-on pins shall start within 3" (75 mm) of the transverse edges of the liner. Space with a maximum separation of 12" (300 mm) around the perimeter of the duct except that pins shall be a maximum of 4" (100mm) from a corner break. Elsewhere they shall be a maximum of 18" (450 mm) o.c.. All transverse edges shall be coated with adhesive.
- .5 All insulation shall be applied according to manufacturer's recommendations.
- .6 All insulation and components shall have maximum flame and smoke spread ratings of 25 and 50 respectively.

### 3.17 Condensing Units

- .1 Units shall be factory assembled, single piece, air cooled condenser complete with hermetic compressor, air cooled coil, propeller type condenser fan, internal wiring / piping / controls and refrigerant charge (R-410A).
- .2 Units shall have the following approvals / ratings:
  - a. Rated in accordance with the latest edition of AHRI Standard 210.
  - b. Certified for capacity and efficiency, and listed in the latest AHRI directory.
  - c. Unit construction shall comply with the latest edition of ANSI / ASHRAE and with NEC.
  - d. Unit shall be constructed in accordance with UL standards and will carry the UL label of approval.
  - e. Units shall have c-UL-us approval.
- .3 The unit cabinet shall be constructed of galvanized steel, bonderized and coated with a powder coat paint.
- .4 The condenser fan shall be direct drive propeller type discharging air upward. The condenser fan motor shall be totally enclosed, 1-phase type with class B insulation and permanently lubricated bearings. Shafts shall be corrosion resistant. The fan blades shall be statically and dynamically balanced and the fan openings shall be equipped with coated steel wire safety guards.
- .5 The compressor shall be hermetically sealed and shall be mounted on rubber vibration isolators.
- .6 The condenser coil shall be air cooled and shall be constructed of aluminum fins mechanically bonded to copper tubes which are then cleaned, dehydrated and sealed. Factory leak test at 150 PSIG (1035 Kpa) and pressure test at minimum 450 PSIG (3100 Kpa).

- .7 Refrigeration circuit components shall include liquid line shut-off valve with sweat connections, vapor line shut-off valve with sweat connections, internal pressure relief valve, filter drier for R-410A refrigerant and system charge of R-410A refrigerant and compressor oil.
- .8 Provide internal thermal overload.
- .9 Unit electrical power shall have a single point connection. The control circuit shall be 24 volts.
- .10 Units shall be Carrier. For model, accessories and performance requirements, refer to Equipment Schedule on the drawings.

### 3.18 Louvres (Less Than 4 sq ft - 0.37 sq m)

- .1 Ventex or approved equal model 2220 / 2225, 2" (50mm) deep, 45 degree storm proof blades at 3.125" (79mm) centers.
- .2 Provide channel or flange frame to suit application.
- .3 Frame and blades shall be constructed of extruded aluminum 6063-T5. Minimum thickness of frame and blades shall be .062" (1.5mm). Blades shall have a weather stop.
- .4 Louvre shall be assembled with cadmium plated steel screws.
- .5 Provide Polyester baked enamel finish of colour to suit Architect selected from standard colours.
- .6 Provide 0.5" x 0.5" (13x13mm) 19 gauge galvanized birdscreen mounted to inside face in removable frame, extended sill for channel frames and extended sleeve where required by ductwork configuration.

### 3.19 Louvres (Greater Than 4 sq ft - 0.37 sq m)

- .1 Ventex or approved equal series 2430/2435, 4" (100mm) 35 degree storm proof blades at 3.5" (89mm) centers.
- .2 Provide channel or flange frame to suit application.
- .3 Frame and blades shall be constructed of extruded aluminum, alloy 6063-T5. Minimum thickness of frame and blades shall be .081" (2.06mm). Blades shall have a weather stop.
- .4 Provide stainless steel fasteners.
- .5 Multiple panels shall be made of equal size with hidden mullions to achieve an uninterrupted blade appearance.
- .6 All materials shall be factory finished after assembly with a Polyester Powder coat finish in a colour to suit Architect selected from the standard colours.
- .7 Provide 0.5" x 0.5" (13x13mm) 19 gauge galvanized birdscreen mounted to inside face in removable frame and extended sill for channel frames.

### 3.20 Rooftop Units

#### .1 General

- a. Unit shall be fully assembled at the factory and consist of an insulated metal cabinet, downturn outdoor air intake with 2" aluminum mesh filter assembly, exhaust air blower, hot gas reheat coil, air-source heat pump, phase and brownout protection, motorized dampers, motorized recirculating damper, curb assembly, filter assembly intake air, supply air blower assembly, and an electrical control center. All specified components and internal accessories factory installed are tested and prepared for single-point high voltage connection.

#### .2 Cabinet

- a. Materials: Formed, double wall insulated metal cabinet, fabricated to permit access to internal components for maintenance.
  - i. Internal assemblies: 24 gauge, galvanized (G90) steel except for motor supports which shall be minimum 14 gauge galvanized (G90) steel.
- b. Cabinet Insulation: Comply with NFPA 90A and NFPA 90B and erosion requirements of UL 181.
  - i. Materials: Rigid urethane injected foam. Foam board not acceptable.
    - 1) Thickness: 2 inch (50.8 mm)
    - 2) Thermal Resistance R13
    - 3) Thermally broken
    - 4) Meets UL94HF-1 flame requirements.
    - 5) Location and application: Full coverage of entire cabinet exterior to include walls, roof of unit, unit base, and doors.
- c. Roof Insulation: 2 inch (50.8 mm) fiberglass located above the 1 inch (25.4 mm) foam panel.
- d. Access panels / doors: Unit shall be equipped with insulated, hinged doors or removable access panels to provide easy access to all major components. Doors and access panels shall be fabricated of 18 gauge galvanized G90 steel or painted galvanized steel.
- e. Supply Air blower assemblies: Blower assembly shall consist of an electric motor and direct-drive fans. Assembly shall be mounted on heavy gauge galvanized steel rails and further mounted on 1.125 inch thick neoprene vibration isolators. Blower motors shall be capable of continuous speed modulation and controlled by a VFD.
- f. Control panel / connections: Units shall have an electrical control center where all high and low voltage connections are made. Control center shall be constructed to permit single-point high voltage power supply connections. RTU shall be equipped with a Unit Disconnect Switch.
- g. Condensate drain pan: Drain Pan shall be an integral part of the unit whenever a cooling option is included. Pan shall be formed of welded austenitic stainless steel sheet material and provided with a welded stainless steel drain connection at the front for connection to a P trap. Drain pan shall be sloped in two directions to provide positive draining and drain connector shall be sealed at penetration through cabinet wall.
- h. P trap: If the unit is equipped with a condensate drain pan, contractor shall provide, or fabricate, and install an appropriate P trap, in accordance with all local and area codes and Best Practices.

- i. Reheat coil with factory installed modulating hot gas reheat valve.
- j. Indirect gas furnace
  - i. Shall be ETL Certified as a component of the unit.
  - ii. Shall have an integral combustion gas blower.
  - iii. Shall be ETL Certified for installation downstream of a cooling coil.
  - iv. Shall have fault sensors to provide fault conditions to optional digital controller or building controls.
  - v. Shall have 4-pass tubular heat exchangers, constructed of type 409 stainless steel. Heat exchanger tubes shall be installed on the vest plate by means of swaged assembly, welded connections are not acceptable. Heat exchanger tubes shall be supported by a minimum of two fabricated assemblies that support the tubes and also permit expansion and contraction of the tubes.
  - vi. Heat exchanger shall have a 25 year extended warranty.
  - vii. Furnace control shall be HighTurndown 16:1 Modulating.
  - viii. Shall be encased in a weather-tight metal housing with intake air vents. Large, metal lift-off door shall provide easy access to the enclosed vest plate, control circuitry, gas train, burner assembly and exhaust blower.
  - ix. Shall have solid state controls permitting stand-alone operation or control by building controllers.
  - x. Indirect gas heat shall be able to simultaneously operate with the air-source heat pump.
- k. Air-Source Heat Pump: Unit shall have an integral compressor(s) and indoor coil located within the weather-tight unit housing. Outdoor coils and appurtenant outdoor fan assemblies shall be factory installed as integral subassemblies of the unit and mounted on the exterior of the unit. Lead condenser fan(s) will have an electronically commutated (EC) motor that will modulate to maintain a head pressure set point.] Motors shall be UL Recognized and CSA Certified. The lead refrigerant compressor shall be inverter hermetic scroll-type. Compressors shall be equipped with liquid line filter drier, expansion valve, accumulator, sight glass, manual reset high pressure and low-pressure cutouts and all appurtenant sensors, service ports and safety devices. Compressed refrigerant system shall be fully charged with R-410A refrigerant. Each compressor shall be factory-equipped with an electric crankcase heater to boil off liquid refrigerant from the oil.
- l. Condenser Fans: Fan blades must be constructed of aluminum or a composite material and have a geometry designed and documented to reduce sound and energy when compared to a traditional rectangular blade fan. Traditional rectangular blade fans are not allowed due to increased noise generated and increase power utilized. Condenser fan motors shall be three phase, external rotor, type 56 frame, open air over and shaft up. Each condenser fan motor shall have a vented frame, rated for continuous duty and be equipped with an automatic reset thermal protector. Lead condenser fan(s) will have an electronically commutated (EC) motor that will modulate to maintain a head pressure set point.] Motors shall be UL Recognized and CSA Certified. Single condenser fan running at max RPM and design static pressure shall not exceed an A-weighted sound power level of 75 db at free inlet/outlet test conditions.
- m. Phase and brownout protection: Unit shall have a factory-installed phase monitor to detect electric supply phase loss and voltage brown-out conditions. Upon detection of a fault, the monitor shall disconnect supply voltage to all motors.
- n. Motorized dampers / Intake Air, Motorized dampers of low leakage type shall be factory installed.

- o. Curb Assembly: A curb assembly made of 14 gauge galvanized steel shall be provided by the factory for assembly and installation as part of this division. The curb assembly shall provide perimeter support of the entire unit and shall have duct adapter(s) for supply air and return air. Curb assembly shall enclose the underside of the unit and shall be sized to fit into a recess in the bottom of the unit. Contractor shall be responsible for coordinating with roofing contractor to ensure curb unit is properly flashed to provide protection against weather/moisture penetration. Contractor shall provide and install appropriate insulation for the curb assembly. The curb shall be the height of 24 in.

.3 Blower

- a. Blower section construction, Supply Air: direct drive motor and blower shall be assembled on a 14 gauge galvanized steel platform and shall be equipped with 1.125 inch thick neoprene vibration isolation devices.
- b. Blower assemblies: Shall be statically and dynamically balanced and designed for continuous operation at maximum rated fan speed and horsepower.
- c. Fan: Direct drive, airfoil plenum fan with aluminum wheel statically and dynamically balanced. Prop or belt-drive fan not acceptable due to low static capabilities.
- d. Blades: Welded aluminum blades only.
- e. Blower section motor source quality control: Blower performance shall be factory tested for flow rate, pressure, power, air density, rotation speed and efficiency. Ratings are to be established in accordance with AMCA 210, "Laboratory Methods of Testing Fans for Rating".

.4 Motors

- a. General: Blower motors greater than 1/2 horsepower shall be "NEMA Premium" unless otherwise indicated. Compliance with EPart minimum energy-efficiency standards for single speed ODP and TE enclosures is not acceptable. Motors shall be heavy-duty, permanently lubricated type to match the fan load and furnished at the specified voltage, phase and enclosure.
- b. Motors shall be 60 cycle, 3 phase 575 volts.

.5 Filters

- a. Unit shall have permanent 2 inch (50.8 mm) aluminum filters located in the outdoor air intake and shall be accessible from the exterior of the unit. MERV 8 disposable pleated filters shall be provided in the supply air stream. MERV 13 disposable pleated filters shall be provided in the supply final air stream.

.6 Controls

- a. Unit shall incorporate heat-cool only controls to allow third-party control while maintaining the safeties of the refrigeration system and heating devices. This controller is responsible for the operation of the refrigeration and heating components installed in the unit. The safety of the refrigeration system is assured by monitoring pressures and temperatures contained within the refrigeration circuit(s). A third-party device interfaces to the Heat-Cool Only controller via a terminal strip. The third party is required to directly control the following: supply fan, dampers, cooling

and heating enable, dehumidification enable, temperature setpoints, and emergency shutdown.

- b. Dirty filter sensor shall be factory-installed.

.7 Field Quality Control

- a. Manufacturer's Field Service: Engage a factory authorized service representative to inspect field assembled components and equipment installation, to include electrical and piping connections. Report results to A / E in writing. Inspection must include a complete startup checklist to include (as a minimum) the following: Completed Start-Up Checklists as found in manufacturer's IOM.

.8 Start-Up Service

- a. Engage a factory authorized service representative to perform startup service. Clean entire unit, comb coil fins as necessary, install clean filters. Measure and record electrical values for voltage and amperage. Refer to Division 23 "Testing, Adjusting and Balancing" and comply with provisions therein.

.9 Demonstration And Training

- a. Engage a factory authorized service representative to train owner's maintenance personnel to adjust, operate and maintain the entire unit. Refer to Division 01 Section Closeout Procedures and Demonstration and Training.

- .10 Units shall be Valent. For model, accessories and performance requirements, refer to Equipment Schedule on the drawings.

**END OF SECTION**

## **1. GENERAL**

### 1.1 General Requirements:

- .1 Refer to Division 20 – Mechanical.

## **2. BUILDING AUTOMATION SYSTEM**

### 2.1 Description of System

- .1 Furnish and install all components, devices and control wiring for a fully integrated energy management and building control system incorporating Direct Digital Control (DDC), and equipment monitoring. The system shall control/monitor HVAC and plumbing equipment and systems as specified in this section. The work shall include but is not limited to the following:
  - a. All necessary hardware, software, control panels, web access modules, control wiring, field devices, installation, documentation and owner training as specified.
  - b. The installed system shall incorporate electronic and digital control devices to perform the control sequences and monitoring outlined herein. Specific control sequence requirements are as detailed elsewhere in this section of the specification.
  - c. VVT zone control dampers shall be installed in the duct system by the Mechanical Trade complete with necessary duct transitions, access doors, etc. The Controls Trade shall be responsible for coordination with the Mechanical Trade and the installation of the actuators.
  - d. Control valves shall be installed in the piping system by the Mechanical Trade complete with transitions and unions as required.
  - e. Testing, debugging, calibrating, adjustment, programming and confirmation of total system operation.
- .2 Manufacturer and Installing Trade
  - a. The control manufacturer shall be TAC Xenta – local representative 519-893-2638.
  - b. Any new building must be a seamless extension of the current energy management and building control system.
  - c. The existing TAC Vista software is, and shall continue to be, the only head-end BAS server for the entire school board.
  - d. The head-end server contains the secure energy management settings (i.e. master setpoints and schedules) that are sent to all schools in real-time. The control system must be an extension of the head-end server and be able to be managed exclusively through the Vista head-end server.
  - e. Monitoring of all school board control systems are done in real-time and must be presented at the exclusive Vista head-end server as first-priority data.
  - f. The Vista head-end server has all the required controller databases and software to be able to centrally maintain and modify network configuration and controller software for the entire school board. The Vista head-end server is the only system that can access the LacNet programming variables inside the controllers for real-time configuration of setpoint and time scheduling parameters.
  - g. The graphics and controller database must be presented inside the Vista head-end server in its native format in order to preserve the real-time speed, integrity and multi-site administration of the entire system.

- h. The controls company shall have a service office and maintenance facility within six kilometers of the Waterloo Region District School Board main office. The controls company shall be able to provide service to any school within four hours during normal working hours.

.3 Quality Assurance

- a. The system components shall be listed by Underwriters Laboratories Inc. and Canadian Standards Association.
- b. The system control products shall be stored and handled according to manufacturer's recommendations.
- c. The work shall be performed by skilled technicians all of whom shall be properly trained and qualified for this work.

2.2 Products

- .1 The system shall integrate the operation of intelligent building management controllers distributed into the network.
- .2 Provide web based access. Two ethernet connections for communication shall be provided by the Electrical Trade.
- .3 The DDC system shall be generally comprised of the following devices to achieve the control functions described in this section:
  - a. Distech 200, 300, 400 and 600 series programmable controllers.
  - b. Distech input/output programmable controllers.
  - c. Distech EC-BOS web server with graphical user interface for this project.
  - d. Network repeaters as required by network lengths.
  - e. Control relays.
  - f. Control dampers and valves.
  - g. Sensors, actuators and other input/output devices.
- .4 Controllers shall execute the application programs, calculations, and commands to provide the control function specified for that unit. Each controller shall include its own micro-computer controller, power supply, input/output modules, termination modules and real time clock.
- .5 Controllers shall be capable of full control functionality and alarm reporting independently or as a part of the DDC network.
- .6 The system shall be stored in flash ram so no batteries are required.
- .7 Each control device shall be modular and expandable to provide additional inputs and outputs and control functionality for that device.
- .8 Each controller shall be able to transfer and receive data via the network for performance of control functions.
- .9 The system shall be modular, permitting expansion by adding hardware and software without changes in communication or processing equipment.



- .10 The complete system shall be capable of communication over a LonWorks network.
- .11 The controllers shall monitor the status of all overrides and include this information in logs and summaries to inform the operator that automatic control has been inhibited.
- .12 Controllers shall continuously perform self-diagnostics, communication diagnosis and diagnosis of all subsidiary equipment and provide both local and remote annunciation of any component failures.
- .13 Controllers shall activate an orderly shutdown of their operation in the event of loss of normal electrical power. Non-volatile memory shall be incorporated for all controller configuration data. The controllers shall automatically resume full operation without manual intervention.
- .14 The controllers shall have sufficient memory to support their own operating system and data bases including:
  - a. Control processes.
  - b. Energy management applications.
  - c. Alarm management.
  - d. Trend data.
  - e. Operator input/output.
  - f. Remote communications.
  - g. Manual override monitoring.
- .15 Controllers shall incorporate the following software features:
  - a. Energy management:
    - i. Time of day scheduling.
    - ii. Calendar based scheduling.
    - iii. Holiday scheduling.
    - iv. Optimal start and stop.
    - v. Demand limiting.
    - vi. Heating/cooling interlock.
  - b. Alarm management:
    - i. Alarm management shall be provided to monitor, buffer and direct alarm reports to operator devices and memory files. The controllers shall perform alarm analysis and filtering to minimize operator interruptions due to non-critical alarms, minimize network traffic and prevent alarms from being lost.
    - ii. All alarm or point change reports shall include the points' English language description and the time and date of occurrence.
    - iii. The user shall be able to define the specific reaction for each point, the priority level (three in total) and ability to inhibit alarm reporting for each point.
    - iv. The user shall be able to define conditions under which point changes need to be acknowledged by an operator and logged for analysis at a later date.
    - v. The user shall be able to print, display or store a unique sixty character alarm message to more fully describe the alarm condition or direct operator response. The message shall be customizable to describe each individual alarm.
    - vi. In web access applications, only critical alarms shall initiate a call to a remote operator device, otherwise call activity shall be minimized by time stamping

- and saving reports until a manual request is received or until the buffer space (minimum fifty alarms) is full.
- c. Trend logs:
    - i. Controllers shall provide an automatic roll-over trend log, which stores records up to an operator-selected number at an operator-selected sampling rate and then overwrites the oldest record with each new record.
    - ii. Sample intervals shall be from one minute to twenty-four hours.
    - iii. Provide graphical and tabular displays.
  - d. Runtime totalization:
    - i. The controllers shall automatically accumulate and store runtime hours for binary points with a sampling resolution of one minute. The user shall have the ability to define a warning limit to trigger maintenance or user-defined messages.
  - e. Event totalization:
    - i. Controllers shall have the ability to count events (such as on/off) and store up to ten million events before reset with a user-defined limit used to trigger a user-defined message.
  - f. Custom programming:
    - i. The controllers shall permit user defined custom control processes based on:
      - 1) Any system measured data or status.
      - 2) Any calculated data.
      - 3) Any results from other processes.
      - 4) Boolean logic.
  - g. The custom processes may be triggered by:
    - i. Time-of-day.
    - ii. Calendar date.
    - iii. Events (point, alarm, etc.).
- .16 The control strategy for each control loop shall be performed by software within the controller. The sequence of events required for each control loop is described for each system in the control sequence.
- .17 Outdoor air temperature indication shall be available at each controller as an integral part of the control strategies for that controller. Should the network transmission of the common outdoor air temperature (or any other common value) fail, then each controller shall use the last good value received.
- .18 Controls and Requirements for VVT Systems
- a. Where VVT controls are specified, units are to operate as part of a variable volume/variable temperature system complete with all necessary controls including zone dampers, temperature sensors, static pressure sensor probes and bypass damper.
  - b. There shall be no zone controllers for the room control. Control shall be from a designated programmable controller for each air handling unit to ensure information transfer is fast enough to react to the changes in the environment.
  - c. The VVT control system shall include but not be limited to individual DDC room/zone sensors, corresponding zone dampers, bypass damper, connecting communication network, all required duct sensors, all required relays and other required control components and algorithms for complete control of the HVAC system according to the sequence of operation.

- d. Each VVT system shall be capable of operating as a stand alone system. Note that each VVT rooftop unit shall have its own designated controller that controls all zones directly in order to keep information exchange quicker and more efficient.

.19 Network Architecture

- a. The controllers on the local network shall communicate via a two wire LonTalk TP/FT-10 network.
- b. The control network shall be able to expand to match the requirements of the facility, including any future building additions.
- c. The control network shall be able to support a total developed length of 305 meters without using a network repeater.

.20 Control Panels

- a. Control panels shall be fully enclosed cabinets with all steel construction. Cabinets shall have a hinged door with locking latch or bolt-on cover plate. All cabinet locks shall be common keyed. Cabinets shall be finished with two coats of paint.

.21 Temperature Sensors

- a. Provide thermistor temperature sensors, not requiring transmitters, to measure temperature.
- b. Accuracy shall be +/-0.2°C from 0 to 70°C.
- c. Space sensors in occupied areas shall be Greystone TE200 series, type AE or equal having an integral push button for unoccupied override and an integral slider to adjust set point (LED display not required).
- d. In corridors and where noted on the drawings, provide stainless steel plate type sensors (push button override and LED display not required), Greystone TE200 series, type AS or equal.
- e. Duct temperature sensors shall be Greystone TE200 series, type B or equal having a stainless steel probe length to suit application and ABS enclosure. Duct averaging temperature sensors shall be Greystone TE200 series, type FD or equal having an element length to suit application, copper probe and ABS enclosure.
- f. Immersion temperature sensors shall be Greystone TE200 series, type C or equal having a ¼" OD stainless steel probe, 4" long and ABS enclosure. Immersion sensors shall be complete with thermowells. Thermal conductive compound shall be added inside the thermowell to provide optimum thermal transfer from the fluid to sensor. Stainless steel thermowells shall be used for steel pipe and brass thermowells shall be used in copper pipe.
- g. Outdoor temperature sensors shall be Greystone TE200 series, type F or equal having an ABS gasketed cover. A thermal radiation cover shall limit the sensor to solar radiation exposure.

.22 Carbon Dioxide Sensors

- a. Sensors shall Greystone CDD series or equal having the following features:
  - i. 0-2000 ppm factory default detection range, field adjustable.
  - ii. Non-dispersive infrared sensing element with self-calibration algorithm.
  - iii. Guaranteed five year calibration interval.
  - iv. Powered by either AC or DC source.

- v. Accuracy: within 50 ppm or 3% of reading (whichever is greater).
- vi. Operating humidity range: 0-95% RH.
- vii. Operating temperature range: 0 to 50°C or greater.
- viii. Stability: less than 2% full scale in 15 years.
- ix. Response time: less than 2 minutes for 90% step change.
- b. Duct mounted sensors shall be complete with ABS enclosure complete with sampling tube.
- c. Space mounted sensors shall be executive space type without LCD display.

.23 WT System Dampers and Operators

- a. Rectangular dampers shall be Nailor 1010 or equal, parallel blade type complete with blade and edge seals. Use low profile dampers for heights less than 12". Dampers with heights less than 10" shall be single blade.
- b. Round dampers shall be Nailor 1090 or equal complete with blade gaskets and mounting bracket.
- c. Actuators shall be Belimo LMB24-SR-T or equal, proportional control, non-spring return, direct coupled, 24 V for 2-10 VDC or 4-20 mA, 45 in-lb torque, suitable for a maximum damper size of six square feet.

.24 Water Control Valves

- a. Heating and cooling control valves shall be Belimo CCV series characterized ball valves, complete with chrome plated brass trim and NPT female pipe connections. Radiation valves shall be complete with non-spring return modulating actuators. Control valves for coils heating a portion of outdoor air shall have spring return modulating actuators.
- b. Control valves shall be sized to provide approximately one half the circuit branch pressure drop to obtain good modulation control but they shall be no smaller than two pipe sizes less than the pipe they are installed in.
- c. Control valves in contact with domestic water (domestic flush valve) shall be Belimo HTCCV high temperature characterized ball valve with stainless steel ball and stem, NPT female pipe connections and TFX24 spring return to closed position actuator.

.25 Differential Pressure Sensors

- a. Differential pressure sensors shall be provided for liquid or air differential pressure applications. The differential pressure range shall be selected to match the application. Select materials suitable for the measured variable (i.e. water or air) and to withstand a minimum of two times the maximum pressure of the highest pressure range.
- b. Each sensor shall be provided with an industry standard, 0 to 10 Vdc output signal mounted at the sensor. The transmitter and sensor shall have a combined accuracy and repeatability of 1.0% of the differential pressure range. A push button zero adjustment shall be provided.

.26 Freezestats

- a. Freezestats shall be complete with a vapour filled 20 foot bulb and 4 foot capillary. Wire freezestats to shut down the respective fans should temperature over any 12 in

of sensor length drop below the adjustable setpoint (2°C). Freezestats shall have manual resets.

### 2.3 Execution

- .1 Installation
  - a. All controllers and components in the system and on the network shall be installed according to manufacturer recommendations, general installation standards for digital controls and in accordance with the approved shop drawings.
  - b. Locate room sensors in the locations shown on the mechanical drawings. All sensors shall be mounted at barrier free height (3'-11" above finished floor).
  - c. All control components for off site system access shall be located where noted on the drawings. The Electrical Trade shall provide all required connections / cabling for off site access to the web access components.
  - d. All programmable controllers, web access components, relays and other control components shall be located within control panels. Control panels shall be wall mounted and shall be located within suspended ceiling spaces or other locations approved by the Consultant.
  - e. The Electrical Trade will provide hand-off-auto switches in all starters controlled by the BAS.
  - f. The Electrical Trade will provide dedicated 120 VAC, 15 ampere power circuits wired to junction boxes on each floor for controls transformers.
  - g. The supply of all motorized temperature control dampers complete with actuators shall be by this section, except for dampers and actuators supplied with packaged air handlers. All dampers shall be installed into the duct system by the Mechanical Trade complete with necessary duct transitions, access doors, etc. The Controls Trade shall be responsible for the actuators and all coordination with the Mechanical Trade.
  - h. The supply of all automatic control valves shall be by This Section. All valves shall be installed into the piping system by Mechanical Trade complete with necessary fittings, etc. The Controls Trade shall be responsible for all coordination with the Mechanical Trade.
- .2 Generally, duct mounted carbon dioxide sensors shall be used where specified for air handling units; but, for single zones, a wall mount carbon dioxide sensor shall be mounted next to the room temperature sensor.
- .3 All carbon dioxide levels which are measured by the carbon dioxide sensors shall be made available to the Owner in the form of trend logs. Record readings at 10 minute intervals and keep them for at least 30 days.
- .4 Freezestats shall be installed so that their sensing element runs horizontally across the coil face (not diagonally) with no more than 12" vertical drops at the outside coil frame. The full face of the coil shall be covered with no horizontal runs being more than 12" apart. The top and bottom horizontal run shall be within 6" of the coil frame. If more than one freezestat is required they shall be wired in series in order to detect a low temperature in portion of the coil. The sensing elements shall be firmly secured in place to avoid vibration without added air restriction.
- .5 System Start-up and Acceptance

- a. Upon completion of installation, test, adjust and calibrate controls provided under this Section.
- b. On system completion, a demonstration of complete system operation shall be made to the Owner's authorized representative and Consultant.
- c. The Consultant shall verify through the Owner's representatives that the entire system is complete and operating to the satisfaction of the Owner before final acceptance is approved.

.6 Training

- a. The Controls Trade shall provide competent instructors to give full instruction to designated personnel in the adjustment, operation and maintenance of the system installed rather than a general training course. Instructors shall be thoroughly familiar with all aspects of the subject matter they are to teach. All training shall be held during normal work hours of 8:00 a.m. to 4:30 p.m. weekdays as follows:
- b. Provide 4 hours of training for Owner's operating personnel. Training shall include:
  - i. Explanation of drawings, operations and maintenance manuals.
  - ii. Explanation of web access program.
  - iii. Explanation of adjustment procedures.
  - iv. Trend analysis.

.7 Identification

- a. Provide system identification and provide nameplates identifying the following (nameplates shall be keyed to the wiring diagrams):
  - i. Duct mounted sensors.
  - ii. Control panels (identify as to equipment / systems controlled). Each panel shall include an as-built drawing showing all the connected control points.
  - iii. Identify the emergency ventilation control switch with 'GLOBAL ROOFTOP UNIT CONTROL - VENTILATION LOCKOUT'.

.8 Testing and Balancing

- a. During the system testing and balancing by the Balancing Trade, demonstrate the operation of all controls. During balancing procedures, set controls to a fixed mode (bypass damper locked fully closed and all zone dampers locked fully open) to prevent any changes during the balancing procedure.
- b. To ensure excessive noise is not generated by the VVT systems, the following shall be performed:
  - i. For each VVT system, the Balancing Trade shall measure the static pressure in the main duct at the location of the bypass damper using a manometer when the system has been stabilized (all zone dampers are full open and the bypass damper is full closed). This information shall be given to the Controls Trade for verification that the VVT system is properly calibrated.
  - ii. For each VVT system, 10% of the dampers shall be set to the full open position and 90% shall be set at their minimum position (fully closed). When operating with these damper positions, the static pressure in the main duct at the location of the bypass damper shall again be measured by the Balancing Trade using a manometer to ensure it remains at the value measured when in the stabilized mode. This information shall be given to the Controls Trade for verification that the VVT system is operating correctly and

is properly calibrated.

.9 Electrical Wiring

- a. Control transformers for the building automation / VVT temperature control systems shall be supplied and wired by the Controls Trade from 120 V power sources in junction boxes provided by the Electrical Trade (at least one at each end of each floor accessible above ceiling tile in a corridor). All low voltage wiring (below 50 V) to the building automation / VVT temperature control systems shall be by the Controls Trade.
- b. All wiring shall be installed to the standards specified in the Electrical Division.
- c. Use Echelon recommended orange jacket cable for all network wiring.
- d. Run all wiring in EMT conduit where exposed, where running within concrete block walls and where required by the Ontario Electrical Code (conduit supplied and installed by the Controls Trade). Plenum rated cable shall be used in return air ceiling plenums.
- e. Where wiring runs through corridor suspended ceiling spaces, run in wall hooks where possible. The wall hooks shall be provided by the Electrical Trade where indicated on the electrical drawings.
- f. Control relays necessary for BAS operation shall be provided by the Controls Trade but all contactors and their power supplies handling power wiring to the equipment shall be by the Electrical Trade.

.10 General Requirements for VVT Systems

- a. Each VVT system shall be capable of maintaining an independent setback schedule. If any over-ride pushbutton in the associated system is activated, the complete VVT system shall reset to occupied mode for a pre-set time period. At the end of the override time period, setback mode will resume.
- b. Each zone thermostat shall be capable of maintaining independent comfort setpoints, adjustable by the zone occupants. The upper and lower limits of the permissible setpoint range shall be adjustable by the operator.
- c. When the HVAC unit is not in the heating or the cooling mode, the system shall go to ventilation mode. Ventilation mode is automatically sequenced every 20 minutes to avoid stale air in the space. The duration of ventilation mode is 5 minutes, after which the system resumes heating / cooling mode as required.
- d. Zone damper control shall be proportional modulation, not two- position control. Each zone thermostat shall be capable of initiating a heating or cooling mode. Averaging zone systems are not acceptable.
- e. The pressure control system must display duct static pressure and modulate the bypass damper or supply fan speed to maintain the desired system static pressure. During changeover from heating to cooling or cooling to heating the bypass controller will take control of all dampers in order to purge the duct system of extreme temperature air. Systems that use a time delay during system mode changeover are not acceptable.

2.4 Sequence of Operation

.1 General

- a. All setpoints shall be adjustable.
- b. Outdoor air temperature shall be broadcasted to all controllers.
- c. A new outdoor air sensor shall be provided on a different north face and the minimum of this sensor and the original will be used for this building.
- d. Heating mode: Heating is enabled between October 15 and April 15 or if the outdoor air temperature is below 10°C. This heating mode is used in all controllers for the building.
- e. Cooling mode: Mechanical cooling is enabled if the outdoor air temperature is above 14°C.
- f. Carbon dioxide damper override: In any air handling system with a return air or room air carbon dioxide sensor, it shall override the minimum position of the outdoor air damper during occupied mode. It shall override the minimum outdoor air damper between 0 and 40% as the carbon dioxide varies between 1000 and 1200 ppm. All limit controls shall take priority to maintain safe supply air temperatures. An alarm shall be generated if the carbon dioxide level is higher than 1700 ppm or lower than 200 ppm.
- g. Occupancy mode shall be determined by a weekly schedule with an annual holiday schedule. Each system shall have this schedule but there shall be provision for operating under a general (to the building) schedule as well. An adjustable parameter shall be available to select the local or general schedule for each system.
- h. Lead/lag: Devices designed for lead lag operation shall operate in automatic lead/lag mode to equalize run time. If the lead unit fails the lag shall automatically start and an alarm shall be generated. The lead unit shall be advanced through the series of devices in sequence every Tuesday at noon.

.2 See the graphical sequences at the end of this specification.

**END OF SECTION**



## **1. DIVISION 26 COMMON WORKS**

### **1.1 General Requirements**

- .1 The Procurement and Contracting Requirements as outlined under Division 00, and the General Requirements as outlined under Division 01, and all addenda thereto shall apply to and govern all portions of the electrical work.
- .2 Reference Division 27 and Division 28 for additional requirements.
- .3 Points not specifically mentioned shall be in strict accordance with the Ontario Electrical Safety Code (OESC) and regulations of the Electrical Inspection Department from which the permit was obtained. The latest revisions and/or amendments to this Code, with applicable date restrictions, shall also govern work on this contract.
- .4 It is the intent of these specifications to supply and install all materials and equipment as herein specified, and/or shown on the drawings in such a manner as to leave each of the systems of the electrical trades complete and in satisfactory operating condition. Provide all products and methods specified or shown complete with incidentals necessary for a complete operating installation. The contract documents are not intended to enumerate each and every detail which may be necessary to furnish and install the complete system connected up ready for service operation. The bid shall include all such details, and all associated labour and materials, to provide a complete and working system. The omission of any details in the contract documents shall not be a warrant for the installation of poor workmanship or materials, or the omission of such details. The scope of the work to be performed by the Contractor shall be obtained by a careful examination of these specifications and all electrical drawings.
- .5 These specifications are to be considered as an integral part of the plans which accompany them, neither the plans nor the specifications shall be used alone. Any item or subject omitted from one but which is mentioned or reasonably implied in the other shall be considered as properly and sufficiently specified and must, therefore, be provided by the Contractor. Misinterpretation of either the plans or the specifications shall not relieve the Contractor of responsibility.
- .6 The Electrical Subcontractor shall be held responsible for the satisfactory completion of all work bearing upon their trade.
- .7 The Electrical Subcontractor must make note of any inaccuracies or inconsistencies in the drawings and/or specifications. Prior to bid close, any such items shall be disclosed, following the procedure outlined in the Invitation to Proponents.
- .8 Within this design, the term "provide" is defined as "supply and install".
- .9 Extra charges for premium time labour shall be included in the bid price as required to comply with the construction schedule and the restrictions on when work will be permitted in the existing building. Allow for after hours, weekend and holiday labour requirements.
- .10 Re-mobilization of any resources or sub-trades as required to maintain schedule or construction sequencing shall be included.

### 1.2 Questions

- .1 Questions pertaining to the work shall be submitted to the Consultant in writing in the form of a Request for Information (RFI).
- .2 Allow for up to two weeks for RFI response from the Consultant. Claims for delay within this period will not be accepted.

### 1.3 Codes, Permits and Submissions

- .1 All work shall comply with the OESC (current edition, including all bulletins and amendments) and all local and municipal codes and Government agencies having jurisdiction.
- .2 It is understood that the Subcontractor has examined and checked all drawings and specifications with the local authorities and the equipment and materials supplied by the Subcontractor shall have the approval of CSA, ULC, Factory Mutual (FM) and any other authority having jurisdiction.
- .3 The Electrical Subcontractor shall obtain and pay for all necessary permits and inspection fees as may be required by the public administrative authorities having jurisdiction. Any changes or alterations required by an authorized inspector shall be rectified by the Electrical Subcontractor without charge to the Owner.
- .4 Plans have not been submitted to the Electrical Safety Authority (ESA) Plans Approval Department. In accordance with the requirements of 2-010 of the OESC, plan submission is not required for this project.
- .5 All new electrical equipment must conform to the regulations of the Ontario Electrical Safety Code (OESC). Anything necessary to make the equipment comply with these requirements shall be provided without additional cost to the Owners.
- .6 Submit all required documentation to the authorities for their approval and comment before starting any work. Provide all additional drawings, details or information as may be required.
- .7 Inform the Consultant in writing if modifications to the work are requested by the authorities. Provide complete written description of the concerns raised.

### 1.4 Standards of Workmanship and Materials

- .1 All materials supplied by the Contractor shall be new and of the quality specified. All such materials shall be certified by CSA or other organization approved by the ESA. For any material not so certified, the Electrical Subcontractor shall obtain special approval of the local Inspection Authority and shall bear all inspection charges levied and any modification cost required.

### 1.5 Quality Assurance and Regulatory Agencies

- .1 All materials, installations supplied and performed by the Electrical Subcontractor shall be new and meet the standards of quality as specified herein:
  - a. Canadian Standards Association - CSA.

- b. Ontario Regulation 332/12 (Ontario Building Code) - OBC with amendments.
- c. Local Fire Codes.
- d. Ontario Ministry of Labour.
- e. Ministry of the Environment.
- f. Ontario Electrical Safety Code.
- g. Local Electrical Inspection Department.

#### 1.6 Contractor's Shop

- .1 Each Subcontractor shall provide their own office, workshop, tools and materials storage as required, and be responsible for any loss or damage thereto.

#### 1.7 Setting Out of the Work

- .1 The electrical trade shall be responsible for correcting all work completed contrary to the intent of the drawings and specifications and shall bear all costs for same. Where the intent of the documents is not clear he shall obtain the clarification of the Engineer before proceeding with the work.
- .2 Where any equipment supplied by the electrical trade must be built-in with work of the other Subcontractors, the Electrical Subcontractor shall be responsible for the supplying of the equipment to be built-in or measurements to allow necessary openings to be left so as not to hold up the work.
- .3 The electrical trade, in setting out of the work, shall reference Architectural, Structural and Mechanical drawings. He shall consult with the respective trades in setting out locations for conduit runs, lighting fixtures, panel assemblies, etc. so that conflicts are avoided and symmetrical even spacing is maintained. Being there first is not a permissible excuse.
- .4 Do not scale drawings for installation purposes. Obtain all dimensions from Architectural plans, manufacturers Shop Drawings and onsite inspections.
- .5 Before submitting bid, carefully examine the site of the proposed work so as to ascertain all existing conditions affecting the work. No extras will be allowed for work necessitated by conditions ordinarily evident on the site.
- .6 Installation of conduits, outlets and equipment in mechanical areas shall not proceed until the installation of mechanical equipment is far enough progressed to avoid conflicts. Position of electrical equipment and outlets shall be adjusted in these areas to coordinate with mechanical equipment.

#### 1.8 Preparation

- .1 The Electrical Subcontractor shall be responsible for all cutting and patching of any building construction made necessary by the installation of the work except in such instances as may be otherwise assigned by the specifications or shown on the drawings. All cutting and patching shall be to the satisfaction of the Consultant.
- .2 Finishing shall be by General trades.

- .3 In areas otherwise unaffected by the work of this contract, trades that are required to disturb existing finishes shall patch the existing surfaces and provide new finishes to the area of the wall or ceiling surface affected. Paint colour shall be selected to match existing. Repainting of entire walls or surfaces is not required unless a reasonable paint match cannot be obtained.
- .4 Existing ceiling tiles and grids shall be removed and replaced as required to permit the work. Ceiling tiles and grids that are damaged, or left with holes shall be replaced with new to match existing.
- .5 All devices required to be removed in walls being renovated shall have the hole patched to match existing. All devices required to be removed in existing walls not being renovated shall have suitable blank cover plates installed.
- .6 Existing concrete structure may contain concealed conduits. The Electrical Subcontractor shall retain the services of a qualified concrete imaging company to scan for existing buried services prior to cutting/coring/drilling.
- .7 The Electrical Subcontractor shall provide all sleeves, inserts, hangers, flashings, back boxes, tubs, junction boxes, etc. required for the completion of the work. Locations shall be coordinated with the respective subtrade into whose materials they are being installed.
- .8 Structural members shall not be cut without the consent of the Structural Engineer. For all necessary cutting, channelling, core drilling, sleeving etc., the Electrical Subcontractor shall provide their own forces and necessary equipment required to complete the electrical installation.
- .9 All floor mounted electrical equipment such as boards, transformers, etc. shall be mounted on 4" (100mm) high concrete pads supplied and installed by this Contractor. All concrete shall be 25MPa complete with a WWF152x152-MW18.7xMW18.7 welded wire mesh installed 2" (50mm) below the surface of the concrete. Provide smooth trowel finish for all concrete surfaces. Clean and roughen existing concrete surfaces under all new pads. The concrete pads shall extend past the edges of all equipment by a minimum of 3" (75mm).

#### 1.9 Temporary Construction Service and Construction Lighting

- .1 Secure temporary service from existing building distribution system.
- .2 Provide construction lighting to meet or exceed Occupational Health and Safety Act requirements.

#### 1.10 Continuity of Services

- .1 Service and distribution system power interruptions shall be kept to an absolute minimum. Power interruptions must be coordinated with the Owner and all other trades by the Electrical Subcontractor. Written application for electrical interruptions must be received from the Contractor indicating the date, time and estimated duration of the interruption. Application for approval of the power interruptions must be submitted to the Owner's and Consultants at least two weeks prior to the requested shutdown date.
- .2 No Electrical work of any description will be permitted during normal school hours in areas inside the building that are normally accessible to students.

- .3 All barricades as required shall be by the Contractor.
- .4 All work shall be coordinated so that there is complete and continuous life safety protection throughout the entire facility (fire alarm and detection, emergency and exit lighting). System down times shall be kept to an absolute minimum.
- .5 Security, fire alarm and detection, and emergency lighting systems must be operational at all times when the contractor is not physically on site. Failure to keep these safety features operational may result in the contractor performing after-hours and weekend fire watch at their own cost.
- .6 At times when the fire alarm and detection system must be de-energized, the following procedure shall be followed:
  - a. Contact the monitoring company to inform them of the shutdown.
  - b. Contact the local fire department to inform them of the shutdown.
  - c. Establish an alternate source of alarm, i.e., telephone, siren, etc.
  - d. Carefully monitor all high risk fire areas such as kitchens and mechanical rooms.
  - e. Ensure all building occupants are aware of the shutdown, the alternate source of alarm, and the time at which the system will be back on line.
- .7 All necessary system interruptions shall occur at a time suitable to the Owner and may be required to be at times that the building is not occupied or outside of regular business hours.
- .8 If overtime work or temporary wiring provisions are required to maintain services as required herein such work shall be included in the bid.

#### 1.11 Demolition

- .1 Existing lighting shall remain for construction purposes. Provide temporary support for existing fixtures to permit demolition. Ensure that there is adequate lighting for construction throughout the entire process.
- .2 The Electrical Subcontractor shall visit the site to examine the existing conditions and make necessary allowances in the bid for removal, rerouting, relocation, and reconnecting of equipment as may be necessary for the execution and completion of this project.
- .3 Wiring, conduits, etc., located in areas being altered or demolished, but feeding outlets or equipment required to remain in service shall be rerouted as required to maintain the continuity of these services, to the satisfaction of the Engineer.
- .4 In areas requiring installation of new duct risers for roof-mounted mechanical equipment, include for relocating conduits that may interfere with new openings. Confirm exact extent of work on site prior to close of bids.
- .5 Include for strapping existing conduits and cables that are not properly supported and are required to remain above ceilings. Determine exact extent of work on site.
- .6 The Electrical Subcontractor shall provide adequate protection to existing equipment throughout the project and particularly where wiring, piping, equipment, etc., have become exposed to mechanical injury or moisture.

- .7 Existing distribution equipment shall be permitted to be reused only as indicated on the drawings.
- .8 Existing equipment being reused shall be checked for proper operation. Reused equipment shall not have any sign of physical abuse or corrosion. Any knockouts removed in existing equipment being reused shall be plugged.
- .9 All wiring made redundant due to demolition/renovation work shall be disconnected and removed to the nearest distribution point upstream that is not affected by demolition/renovation work. All concealed conduit made redundant due to demolition/renovation work may remain provided it does not adversely affect any new installations, unless it is noted to be removed on the drawings. All exposed conduit in finished areas made redundant due to demolition/renovation work shall be removed and the surface patched.
- .10 Existing wiring devices shall not be permitted to be reused. Existing outlet boxes may be reused if in "as new" condition. Existing branch circuit wiring will only be permitted to be reused in existing non accessible walls/ceilings where the existing wiring is of adequate size, has acceptable bonding conductor and is in as new condition.
- .11 Asbestos Containing Material (ACM) will be disturbed in the execution of this contract, comply with the regulation respecting asbestos on construction projects and in buildings and repair operations made under the Occupational Health and Safety Act, Ontario Regulation 654/85 and local requirements pertaining to asbestos. The Designated Substances Report have been bound into this specification. Employ only licensed asbestos removal trades to execute abatement of all asbestos.
- .12 Asbestos Containing Material (ACM) is not expected to be disturbed in the execution of this contract. Refer to the Owner's Designated Substances Report. However, should ACM be uncovered during the work, notify the Consultant immediately so that appropriate instruction can be given.
- .13 Include the cost of retaining an owner-approved subcontractor for the abatement of all ACM within a 600mm radius of any electrical work. Refer to the Owner's Designated Substances Report.
- .14 All existing panel directories, zone legends and distribution equipment identification shall be reworked to reflect any changes made by any demolition/renovation work. All existing wiring device tags shall be replaced to reflect any changes made to the upstream distribution designations.
- .15 The Electrical Subcontractor shall be responsible to ensure that all existing communications and security systems are undamaged during the course of demolition and renovations.

#### 1.12 Disposal

- .1 The Electrical Subcontractor will be responsible for the complete removal of all electrical equipment and systems to permit alterations, all as shown and noted on the plans. This includes removal of all such equipment from the site.

- .2 All miscellaneous equipment being removed shall become the property of the Owner unless shown otherwise. If the Owner has no use for it, all material shall be responsibly disposed of, in a timely manner, by the subcontractor in accordance with all applicable federal, provincial and municipal acts, bylaws and regulations.
- .3 All appropriate measures to the health and safety of employees and WRDSB personnel shall be observed.

#### 1.13 Shop Drawings

- .1 The Electrical Subcontractor shall submit Shop Drawings to the Project Manager and/or Engineer for review. They shall show in detail the design, construction and performance of all apparatus.
- .2 Shop Drawings shall be submitted electronically in editable Portable Document Format (.PDF). Hard copy (paper) format Shop Drawings shall not be processed and shall be recycled.
- .3 Submissions shall be made in a timely manner after award of the contract. The first progress draw request may not be approved unless all Shop Drawings have been received.
- .4 The Engineer's and/or Project Manager's review of Shop Drawings and manufacturer's specifications is general and is not intended to serve as the final check. It shall not relieve the Contractor from responsibility for errors.
- .5 Before submission, the subcontractor shall check all Shop Drawings for accuracy of details, dimensions etc. Do not proceed with work on any item for which shop drawing review has not been performed by the Engineer.
- .6 Any deviations whatsoever from the materials and methods specified herein must be clearly outlined in writing and such an outline must accompany the Shop Drawings of the proposed deviation.
- .7 All Shop Drawings shall be arranged so that all drawings of a particular system are in one file and are in logical order. Shop Drawings that are submitted individually or are not arranged by system shall be rejected. For example, the lighting system Shop Drawings shall be submitted to include each fixture in order as listed in the "LIGHTING FIXTURE SCHEDULE".
- .8 Any materials that require a colour selection shall have colour samples submitted for Owner/Architect review and acceptance. Arbitrary colour selection by the supplier is not acceptable. Any item for which a formal colour selection is not submitted and approved will not be permitted on site.
- .9 Allow maximum two (2) weeks for Consultants review.
- .10 Shop Drawings outlining all components shall be submitted for the following:
  - a. Power distribution equipment including the following:
    - i. Panels.
    - ii. Transformers.
  - b. Lighting fixtures.
  - c. Emergency lighting.

- d. Lighting controls.
- e. Fire alarm and detection components.
- f. Integrated Testing Plan for fire protection and life safety systems.
- g. Wiring devices (refer to Section below).
- h. Fire stopping systems.
- i. Assistive listening systems.
- j. Audio/video systems.

#### 1.14 Use of Electronic Files

- .1 A waiver must be executed prior to release of any electronic files or digital data.
- .2 Electronic documentation for release may consist of drawing files in formats such as Portable Document Format (.PDF), AutoCAD (.DWG), or Revit (.RVT). Specifications, details, schedules, legends, etc. shall generally not be released.
- .3 Electronic documents shall be used only for the specific use outlined in the waiver. The recipient may use this data for this purpose, at their own risk.
- .4 Copyright and ownership of the data are not transferred to the recipient, nor to any other party. The design professional and/or owner retain all rights to the data.
- .5 Data delivered in electronic form may vary from that contained on copies of previous issues. This information is not guaranteed to be accurate. The method of data transfer cannot be guaranteed to be error free, or compatible with the recipient's hardware, software, or systems. Contractors and subcontractors are not relieved of their normal responsibilities to independently check, coordinate, and verify information and dimensions, and to familiarize themselves thoroughly with the project. The documents may have been changed or amended by addendums, bulletins, supplemental instructions, shop drawings, other documents, meetings, and understandings not represented on these files.
- .6 The electronic files shall not be used as a substitute for the contract documents. The author offers no warranty or guarantee, express, implied, or statutory as to the accuracy, reliability, suitability, completeness or fitness of this data for a particular purpose. The company in receipt of these files agrees to the fullest extent permitted by law, to defend, indemnify, and hold the author, their directors, officers, partners, employees, harmless from all losses, claims, liabilities, injuries, damages, and expenses, including attorneys' fees and costs of defense, arising out of the use, misuse, misapplication, or misinterpretation of this data.
- .7 The recipient will not distribute the data to any other firm or individual. Redistribution and copying of the digital data without written authorization from the author writing is prohibited.

#### 1.15 As-Built Drawings

- .1 The Contractor shall provide redline drawings that accurately record the location of all outlets and conduit runs etc., and all circuiting of devices, as installed on site.
- .2 The Consultant shall provide, at no cost, AutoCAD drawing files incorporating Changes and Instructions.



- .3 Prior to Substantial Performance, the Contractor shall edit the electronic files to provide AutoCAD as-built drawings that incorporate all redline information. Associated costs shall be carried in the bid.

#### 1.16 Close-Out Documentation - Maintenance and Instruction Manuals

- .1 Upon project completion, the Contractor shall submit a Maintenance and Instruction Manual as well as as-built drawings. Submit one paper hard copy in a three-ring binder, and one .PDF electronic copy on a suitably sized USB thumb drive. Each manual shall contain one copy of the following:
  - a. Shop Drawings (revised as reviewed by the Engineer).
  - b. Spare Parts Transmittal to the Owners.
  - c. Digital photos indicating each labeled distribution panel with the cover off.
  - d. Megger Test Results.
  - e. Updated panel directories.
  - f. ESA Final Inspection Certificate.
  - g. Fire Alarm Verification Report(s).
  - h. Integrated Testing Report for fire protection and life safety systems.
  - i. Emergency Lighting and Exit Sign Test Report.
  - j. Written Guarantee (Warranty).
  - k. Sign back of the latest Site Review Report to confirm completion.
- .2 Include for updating the Owner's Continuous Safety Services (CSS) ESA log book for all electrical work.

#### 1.17 Testing

- .1 At or near the completion of the project, the Electrical Subcontractor shall provide acceptance tests to demonstrate that the equipment and systems actually meet the specified requirements. Tests may be conducted as soon as conditions permit. These shall include but shall not be limited to the following:
  - a. Lighting system control.
  - b. Emergency lighting function.
  - c. 3000VDC Megger tests on all XLPE insulated feeders, 60A and larger, 15s duration.
  - d. 1000VDC Megger tests on all PVC insulated feeders, 60A and larger, 15s duration.
  - e. Fire alarm and detection system function.
  - f. Voltage drop measurements.
  - g. Proper phase rotation.
  - h. Existing communications and security equipment and associated cabling.
- .2 Concurrently, written approvals or acceptances by local authorities shall be presented. In testing, vary loads to illustrate start-up, sequence, normal shut down and simulate emergency conditions. Final tests may be conducted in the presence of the Consultant.

#### 1.18 Commissioning

- .1 The Electrical Subcontractor shall retain the services of an Integrated Testing Coordinator (ITC) for all systems that are designed to operate together to achieve an overall fire protection and life safety objective, in accordance with OBC 3.2.10.

- .2 Refer to Division 01 for additional commissioning details.

#### 1.19 Warranty

- .1 The electrical trade shall furnish a written guarantee stating that all work executed under this contract will be free from defects of workmanship and materials for a period of two (2) years from the date of Substantial Performance. The period shall in no way supplement any other warranty of a longer period.
- .2 The Electrical Subcontractor will at their own expense, repair and replace all such defective work and other work damaged thereby which fails or becomes defective during the term of the warranty provided that such failure is not caused by improper use.
- .3 Refer to the Division 01 specifications for additional warranty details.
- .4 Include for completion of the WRDSB Project Warranty Card prior to Substantial Performance.

#### 1.20 Electrical Equipment Approved Equals

- .1 Unless specifically stated otherwise, this project has been designed based on the first named manufacturer of each section in the "ALTERNATE MANUFACTURERS LIST" or that specifically listed in the schedules. If the Electrical Subcontractor chooses to use a manufacturer other than the first named manufacturer, it will be their responsibility to ensure that the alternate is equal in all respects to that of the first named manufacturer. The Engineer reserves the right to approve or reject any alternate based upon an evaluation of the equipment proposed. If only one manufacturer is listed then only that manufacturer shall be acceptable.

#### 1.21 Alternate Manufacturers List

- .1 Distribution Equipment
  - a. Eaton
  - b. Schneider Electric (Square D)
  - c. Siemens
- .2 Motor Starters, MCC's, Contactors
  - a. Eaton or Klockner Moeller
  - b. Schneider Electric (Square D) or Telemecanique
  - c. Siemens
  - d. Allen Bradley
- .3 Dry Type Transformers
  - a. Hammond
  - b. Atlas
  - c. Rex
  - d. Marcus
  - e. E-Factor
  - f. Delta

- .4 Switches, Receptacles and Wiring Devices
  - a. Hubbell
  - b. Eaton Wiring Devices
  - c. Pass and Seymour
  - d. Leviton
  
- .5 Lighting Controls
  - a. Acuity
  - b. Lutron
  - c. Hubbell
  - d. Steinel Lighting Controls
  - e. Cooper Lighting Solutions
  - f. Wattstopper
  
- .6 Time Switches
  - a. Intermatic
  - b. Tork
  - c. Paragon
  - d. Eaton Wiring Devices
  
- .7 Support Channels, Cable Tray and Hangers
  - a. Cooper (B-Line)
  - b. Hubbell
  - c. Unistrut
  - d. Canstrut
  - e. Caddy (Erico)
  - f. T.J. Cope (Tyco)
  
- .8 Surface Raceway
  - a. Hubbell
  - b. Wiremold
  - c. Panduit
  
- .9 Fire Stopping
  - a. 3M
  - b. Hilti
  - c. AD Firebarrier
  - d. STI
  
- .10 Lighting Fixtures (Luminaires) - Interior
  - a. Refer to "LIGHTING FIXTURE SCHEDULE"
  - b. Lithonia
  - c. Hubbell
  - d. Signify (Cooper/Eaton/Philips)

- .11 Emergency Lighting
  - a. Refer to "LIGHTING FIXTURE SCHEDULE"
  - b. Stanpro
  - c. Beluce
  - d. AimLite
  - e. Emergi-Lite/Ready-Lite/Lumacell (Thomas & Betts)
  - f. Dual-Lite (Hubbell)
  
- .12 Fire Alarm and Detection
  - a. Chubb Edwards ( UTC Fire & Security)
  - b. Troy Life & Fire Safety Ltd.
  
- .13 Assistive Listening
  - a. Refer to Division 27.
  
- .14 Audio/Visual
  - a. Refer to Division 27.

#### 1.22 Access Doors

- .1 Provide access doors for installation of all concealed electrical equipment requiring accessibility for service and maintenance such as junction boxes, pull boxes, relay enclosures, controls, etc. All doors shall be a minimum size of 8" x 8" (200mm x 200mm) and a minimum size of 24" x 18" (600mm x 450mm) where human access is required unless otherwise noted and shall be complete with positive locking self-opening screwdriver lock. The exact size of all access doors shall be as recommended by the manufacturer to suit the application.

#### 1.23 Equipment Supplied By Others

- .1 The Electrical Subcontractor is to supply all wiring, disconnect switches, motor starters, etc., for all Owner-supplied and mechanical equipment, unless noted otherwise. Detailed equipment information is given on drawings "WIRING FOR EQUIPMENT SCHEDULE".
- .2 The Electrical Subcontractor shall ensure that all equipment is certified by an agency recognized by ESA (CSA, Entela, etc) prior to energization. If such certification is not present, this subcontractor shall arrange for special inspection by ESA, and all costs for this extra work shall be paid by the Owner.
- .3 Coordinate exact electrical requirements for all equipment with Shop Drawings and actual nameplate data. Revise electrical requirements to suit.

#### 1.24 Allowances

- .1 Refer to Section 01 21 00 for allowance details.
- .2 Any ESA inspection charges shall be included in the project cost and shall be paid for by the Contractor.

### 1.25 Substantial Performance Certificate

- .1 Before the Contractor can make application for a Certificate of Substantial Performance the Electrical Subcontractor will be required to provide the following as detailed within this section:
  - a. Maintenance and Instruction Manuals.
  - b. As-Built drawings.
  - c. Testing.
  - d. Commissioning.

### 1.26 Contractor's Liability Insurance

- .1 The successful bidder is to maintain adequate insurance as specified by the Owner's Standard Form of Contract. This insurance is to firmly protect both himself and the Owners from public liability claims and property damage, and all claims under the Workman's Compensation Act. Evidence of insurance coverage shall be filed and approved.

### 1.27 Payment Certification

- .1 Submit monthly draws to the consultant for review and certification. Draws shall provide a complete breakdown of project in a manner acceptable to the consultant. Submit sample progress draw and a proper invoice template to the consultant within one week of award of contract for review.

### 1.28 Extras and Credits

- .1 Only extras and credits approved by the Electrical Engineer or their representative will be allowed and must be submitted for approval before such work commences. They shall be priced individually with a complete breakdown clearly indicating labour costs, material cost, mark-up and taxes. Labour rates and material costs for extras and credits shall be identical. Material shall be valued at current trade prices incorporating all discounts. Only the net difference between an extra and a credit will subject to overhead and profit mark-up.

### 1.29 Spare Parts

- .1 Provide the following components as spare parts:
  - a. Four (4) type "EBA" emergency lighting fixtures.
- .2 Allow for installation of all spare parts in base contract. If not required to be installed, turn over to Owner upon project completion.
- .3 Obtain sign-off by the Owners representative to confirm receipt of all spare parts, accessories and tools. Sign-off shall consist of printed name and signature.

## **2. EQUIPMENT IDENTIFICATION**

### **2.1 General**

- .1 Provide all nameplates for equipment such as panels, starters, disconnect switches, transformers, contactors, etc.
- .2 Nameplates shall indicate Year, Equipment Name, Source and Electrical characteristics (ampacity, voltage, phases, number of conductors), i.e., 2024, Panel "TWA" fed from Board "SE", 200A, 600/347V, 3-phase, 4-wire.
- .3 All equipment/circuits/devices that reference room names or numbers shall be modified as required to reflect the finalized Owner designated room names/numbers. Do not duplicate the room numbers indicated on the drawings.
- .4 Nameplates shall be a stock white lamacoid, with black lettering and with beveled edges. Letters shall have a minimum 0.06", (1.5mm) stroke.
- .5 Nameplate engraving shall be as follows:
  - a. Electrical equipment name: 0.5", (13mm) high.
  - b. Electrical equipment characteristics: 0.25", (6mm) high.
- .6 Equipment nameplates shall be mechanically fastened with tamperproof screws. Equipment nameplates that are fastened with adhesives shall not be acceptable.
- .7 Provide adhesive labeling for wiring devices such as receptacles, switches, etc. Labels shall indicate the circuit(s) that serve the device, i.e., "530.1".
- .8 Provide all warning signs and labels as required by the ESA.
- .9 Provide typed directory cards in all new and revised distribution panels. Hand written directory cards are not acceptable.
- .10 Provide preprinted slip on conductor identification tags for all conductors as they enter electrical enclosures, equipment, and outlet boxes (switches, receptacles, light fixtures, etc). Tags shall be Thomas and Betts "EZCode" SMC series or approved alternate. Cloth or vinyl markers are not acceptable.
- .11 All empty or spare conduit shall be identified with black indelible marker.
- .12 All junction boxes shall be identified with black indelible marker showing the systems with which they are associated, i.e., lighting, receptacles, fire alarm and detection, etc. Where boxes are exposed, identification shall be on the inside of the cover.
- .13 Repaint or refinish all damaged factory applied finishes.

### **3. CONDUIT, RACEWAY, WIRE AND CABLE**

#### **3.1 General**

- .1 All wiring in noncombustible areas, unless otherwise noted, to be CSA approved soft copper, type T90/TWN75 in conduit, unless otherwise required by the Electrical Code for specific areas or environmental conditions.
- .3 Maximum voltage drop at most remote outlet not to exceed 3% in accordance with OESC #8-102. The minimum wire size shall be #12 AWG.
- .4 All low voltage (0-10V) dimming cabling shall be CSA approved soft copper, type T90 installed in raceway or metal armour. The minimum wire size shall be #16 AWG. Wiring colours to be violet and grey. Insulation rating shall be equivalent to the phase conductors serving the lighting fixtures. A cable that combines power conductors with control conductors under one armour may be used.
- .5 All neutral feeder conductors shall be a minimum of two gauges larger than the respective phase conductor, i.e., 3-#3/0 phase conductors shall include 1-#250 neutral.
- .6 There shall be one neutral conductor for each phase conductor in a branch circuit. Sharing of neutrals shall not be permitted.
- .7 Armored cable (BX) may be used in metal stud partition walls, in concrete block walls, and for final drops to fixtures in accessible ceiling spaces. Cable length shall not exceed 3.1m (120") horizontally in accessible ceilings. BX cable shall under no circumstances be run exposed.
- .8 EMT shall be used in dry concrete slabs and for interior exposed surface applications (where permitted). Surface mounted EMT may be permitted on existing finished walls only in areas where there is existing surface mounted EMT within 24" (600mm).
- .9 Rigid PVC (IPEX Scepter or approved alternate) raceways shall be used in or below concrete slabs, or exposed exterior surface applications. Conduit shall be FT4 rated.
- .10 All conduit and wiring is to be concealed in all finished areas including storage rooms unless otherwise approved. EMT conduit shall be permitted above and below surface mounted panels.
- .11 In finished areas with exposed ceilings, conduit and wiring shall be run concealed if possible. If not possible, conduits shall be EMT, surface mounted or suspended to suit the application.
- .12 Exposed or concealed conduits above ceilings shall be run in straight lines parallel to building structure. Diagonal runs will not be permitted.
- .13 Provide 9mm (3/8") polypropylene pull rope and pull tape in all empty conduits 53mm (2") and larger.
- .14 Provide nylon pull tape in all empty conduits smaller than 53mm (2").
- .15 Securely fasten pull rope/tape in empty conduits/raceways at each end.

- .16 Pull tape shall be Neptco WP900P, 0.5" (13mm) wide, 900lb (409kg) pull strength, lubricated, with sequential metric distance markings.
- .17 Conduits and cables shall not enter an exit stair shaft, unless they serve devices/fixtures within the exit stair, i.e., route all conduits and cables around the stair to maintain the integrity of the exit.
- .18 All wiring serving rotating or vibrating equipment shall be stranded and shall be in a flexible raceway. Raceway length shall not exceed 1.5m (60").
- .19 Connections to welding equipment shall be flexible and of sufficient length to permit the equipment to be moved for servicing or housekeeping.
- .20 Coordinate with HVAC trades to run feeders to rooftop equipment through the curb or alongside refrigerant lines. Separate roof penetrations/cones for feeders shall not be permitted.
- .21 Where separate roof penetrations are required, provide roof sleeves complete with flashing and rain shields. Recommended product is PortalsPlus Alumi-Flash.
- .22 All outlet boxes shall be metal. The use of non-metallic boxes shall not be permitted.
- .23 Outlet boxes located in areas normally accessible to building occupants shall have no exposed knockouts. Support all boxes independently of connecting conduits.
- .24 In areas where it is not possible to run conduits concealed in existing structures, surface mounted raceways shall be permitted. The Electrical Subcontractor shall verify the proposed locations of all surface mounted conduits with the Engineer prior to installation.
- .25 Where permitted, all surface mounted raceways shall be "Wiremold" series 2000, 500, or 700, as required to match the quantity and size of conductors. Surface mounted raceways shall be complete with all "Wiremold" fittings and accessories (couplings, bushings, clips, straps, elbows, outlet boxes etc.) to form a complete installation.
- .26 All exposed surface mounted raceways shall be painted by the Electrical Subcontractor to match the colour of the surface upon which it is installed if the surface is not specified to be painted by general trades.
- .27 All wiring situated in a return air plenum shall be totally enclosed in a non-combustible raceways or shall be FT6-rated (also known as Communications Media Plenum, or CMP).
- .28 All conduits and raceway systems shall be provided complete with plastic bushings on both ends.

### 3.2 Fire stopping

- .1 Provide fire stop sealant / devices of a type to suit piping, building construction, opening size, etc. Supply and install according to manufacturers detailed installation instructions.
- .2 Indicate the fire stopping systems to be used at all conduit and wiring penetrations of fire rated building construction. Include certified drawings prepared by the fire stop manufacturer



which are applicable to the application. These drawings shall indicate all certifications, wall / floor construction details, pipe size / material details, SP numbers, F and T ratings, etc. and they shall be keyed to floor plan blue prints which indicate the location of each fire stopping application.

- .3 Coordinate with General Trades to be consistent with the fire stopping manufacturer throughout the project.
- .4 Firestop behind panels, enclosures and outlet boxes greater than 160cm<sup>2</sup> (24.8in<sup>2</sup> or four gang) recessed in fire rated separations using 3M Interam Endothermic Mat E-5A-4.
- .5 Firestop behind enclosures and outlet boxes 160cm<sup>2</sup> (24.8in<sup>2</sup> or four gang) or smaller recessed in fire rated separations in the same stud space and closer than closer than 600mm (24") using Hilti CP617 or CFS-PA Firestop Putty Pads.
- .6 All sleeves/conduits installed to permit the passage of communications cabling through a fire separation shall be caulked with approved fire stopping material after the installation of all required cabling is completed to prevent the spread of smoke. Fire stopping material shall be applied by the Electrical Subcontractor regardless if communications cabling is provided by others. Verify with consultant prior to application.

#### **4. WIRING DEVICES**

##### **4.1 General**

- .1 Provide all wiring devices and their associated fittings as indicated in the "Wiring Device Schedule" in this specification or as specifically noted on the drawings.
- .2 Wiring devices shall be black unless noted otherwise. Verify colour with Owner prior to ordering and adjust if required.
- .3 Wiring devices for general purpose shall be of heavy-duty specification grade.
- .4 Devices shall be manufactured and tested in accordance with CSA and EEMAC standards. Attachment plugs and receptacles to conform to CSA configurations.

##### **4.2 Wiring Device Schedule**

- .1 Hubbell or Acuity serves as the basis for this specification. If the Contractor chooses to use an Approved Alternate manufacturer, as listed above, it will be their responsibility to ensure that the alternate is equal in all respects to that named herein. The Engineer reserves the right to approve or reject any alternate based upon an evaluation of the equipment/device proposed.
- .2 120V Switches
  - a. Decorator Style - 20A
    - i. DS120, DS320, DS420
  - b. Key Switches - 20A
    - i. HBL1221, HBL1223, HBL1224
    - ii. Provide one HBL1209 key with each lock switch
- .3 120V Receptacles
  - a. Ground Fault Circuit Interrupter (Weather and Tamper Resistant) - 15A
    - i. GFTWRST15
  - b. Ground Fault Circuit Interrupter (Weather and Tamper Resistant) - 20A
    - i. GFTWRST20
  - c. Decorator Style - 15A
    - i. HBL2152
  - d. Decorator Style - 20A (CSA 5-20R)
    - i. HBL2162
- .4 250V Devices
  - a. Dryer Receptacles - 30A
    - i. HBL9430
  - b. Range Receptacles - 50A
    - i. HBL9450
- .5 Pop-Up Counter Receptacle:
  - a. Low Electric Fittings Company model PUFFP-CT-GFI-PB.

- i. Single 20A duplex GFCI receptacle.
- ii. IP44 splash proof rated.
- iii. Waterproof gasketting.
- iv. Comes complete with PUFT-CT-PB plastic box.
- v. Fully flush mounted.
- vi. Metal top material.
- vii. Confirm colour and/or material type with Architect prior to ordering.

.6 Time Controls

- a. Push Button Timer:
  - i. Intermatic EI235x, electronic timer with 15, 30, 45, 60, 120 minute presets, single pole, rated for 0.25hp, 8.3A ballast, 1800W Resistive, 120V, colour to match other wiring devices. No hold feature.

.7 Clocks

- a. Typical 300mm clock shall be American Time Model No. E56BADD304BP.
- b. All shall feature round, high impact plastic case with shatter-resistant safety crystal and bold black numerals and minutes markers on a non-yellowing white dial. Provide four AA alkaline batteries for each clock.
- c. Include for custom logo.

.8 Occupancy Sensors for Switching Environments

- a. Refer to the Lighting Control Schedule.
- b. The sensors shall operate at 24VDC, supplied by the PP20 power supply/relay pack. Locate PP20 units on as-built drawings.
- c. Power supply/relay pack input voltage 120V to suit application.
- d. Sensors may be wired in parallel to allow coverage of larger areas.
- e. Extended range 360 degree.
- f. White colour.
- g. Set to minimum 20 minute operation.
- h. Provide quantity of relay packs and slave packs to suit required load and switching arrangement indicated on the plans.
- i. Sensors shall be located and adjusted per manufacturer's instructions to provide detection within the defined area.

.9 Lighting Controls for Dimming Environments (0-10V)

- a. Refer to the Lighting Control Schedule.
- b. Provide a non-booted CAT5e connections.
- c. Provide quantity of bridges, power/relay packs as required.
- d. All luminaires shall come on automatically via occupancy sensor(s) to 50% illumination. Manual control of light levels by the dimmer after detection of occupancy.
- e. All luminaires to automatically dim to off 20 minutes after no occupancy is detected.
- f. Sensors shall be located and adjusted per manufacturer's instructions to provide detection within the defined area.
- g. Manufacturer shall commission and test the entire system. Provide verification report.

- .10 Current Sensing Relays
  - a. Dwyer Model No. CCS-231150.
    - i. Split core housing.
    - ii. Normally open contact: 1A at 240VAC.
    - iii. Adjustable set point: 1.5A to 200A. Set to minimum setting.
    - iv. Self-powered.
- .11 Cover plates
  - a. Plates shall be specification grade type 304 brushed stainless steel.
  - b. Plates serving the ceiling mounted devices shall have a matching white nylon cover plate.
  - c. Surface Exterior While-In-Use Weatherproof Covers:
    - i. Die-cast metal construction, gasketed.
    - ii. Lockable open or closed.
    - iii. Hubbell (Taymac) MX3300.
    - iv. Use only for mechanical equipment.

#### 4.3 Execution

- .1 All wiring devices to be flush mounted in all finished areas.
- .2 All switches shall be rated 20A minimum.
- .3 Where GFCI devices are shown on the drawings, an actual GFCI device must be installed. Feed through type arrangements are not acceptable.
- .4 Receptacles connected to 20A branch circuits shall be CSA 5-20R configuration.
- .5 Install boxes so as to be accessible after building is complete, set to be flush with finished lines of building structure, where recessed, and lined and leveled where surface mounted.
- .6 Switch and receptacle mounting heights shall be coordinated with Architectural details and shall be adjusted, if required to the satisfaction of the Architect/Engineer at no additional cost to Owner.
- .7 Where outlets occur in exterior walls, the electrical trade shall ensure that there is insulation and a vapour barrier behind the outlet box to prevent condensation through the boxes.
- .8 Receptacles for maintenance of HVAC and similar equipment shall be mounted on the exterior of the equipment.
- .9 Noncombustible outlet boxes recessed in rated assemblies shall be tightly fitted (less than 3mm annular space) and shall not exceed 160cm<sup>2</sup> (24.8 in<sup>2</sup>) or four gang. Maximum total of 650cm<sup>2</sup> or eight gangs in any 9.3m<sup>2</sup> (100sqft.) area.
- .10 Firestop behind panels, enclosures and outlet boxes greater than 160cm<sup>2</sup> (24.8in<sup>2</sup> or four gang) recessed in fire rated separations using 3M Interam Endothermic Mat E-5A-4.

- .11 Firestop behind enclosures and outlet boxes 160cm<sup>2</sup> (24.8in<sup>2</sup> or four gang) or smaller recessed in fire rated separations in the same stud space and closer than closer than 600mm (24") using Hilti CP617 or CFS-PA Firestop Putty Pads.
- .12 Outlet boxes located in vertical fire separations shall not be closer than 600mm (24") horizontally or shall be fire blocked to maintain the integrity of the separation. Fire block shall be 13mm gypsum board or 0.38mm sheet steel. Arrange and pay for fire block materials.
- .13 Outlets located in masonry, textured or otherwise uneven wall/surfaces shall be mounted such that the cover plate is flush with the wall/surface. Grind or modify the face of the material so that the cover plate fits flush. The cover plate shall have an opening no larger than 1/8" (3.0mm) from the surface. Caulking shall not be permitted as a method of filling gaps larger than 1/8" (3.0mm).
- .14 Install switches and/or receptacles in ganged type outlet boxes, with matching wall plate when more than one switch or receptacle is required in one location.
- .15 Remove plastic protective film on stainless steel plates only after painting and other work has been completed in that area.
- .16 Do not use cover plates designed for flush outlet boxes on surface mounted boxes. Do not use outlet boxes designed for flush mounting in surface mount applications.
- .17 Locate power connections to Mechanical Power Supplies (MPS) in accessible location where shown on the floor plans.
- .18 All low voltage lighting controls shall be provided with an appropriately sized outlet box and a 0.5" (16mm) conduit to the accessible ceiling space. In cases where the ceilings are not accessible, extend conduit to within 6.0" (150mm) of the nearest associated power/relay pack.

#### 4.4 Mounting Heights

- .1 Mounting heights to centre of box above finished floor (AFF), unless noted otherwise:
  - a. 18", (450mm): receptacles, communications outlets.
  - b. 30", (750mm): exterior receptacles above finished grade/roof.
  - c. 41.5", (1050mm): light controls, timers, wall-mounted telephones, key switches.
    - i. Minimum height is 36" (900mm), maximum height is 43" (1100mm).
    - ii. Maintain minimum of 150mm horizontally from centre of all wall-mounted telephone outlets to the edge of any adjacent device (light control, thermostat, etc.).
  - d. 47", (1200mm): end of line devices.
  - e. 92", (2340mm): fire alarm visual and audible devices without silencing means. Install at least 6", (150mm) below ceiling to the top edge of the device. Visual devices shall not be lower than 78", (2000mm).
  - f. Devices above counter shall be 4" above millwork/back splash. Coordinate with Architectural details.
  - g. Fire alarm device modules and zone isolators shall be recessed in walls at 92" (2.34m) AFF or 6", (150mm) clear below ceiling, whichever is lowest. Clearly indicate location of modules on as-built drawings. Verify locations on site with Architect.

- h. Wall mounted door holders shall be mounted 150mm (6") below top of door being held.
- .2 New controls adjacent to Classroom doors shall be arranged to have thermostat closest to the door, followed by telephone, followed by lighting controls.
- .3 Where devices are to be mounted in block walls, outlet boxes shall be cut into the top or bottom of the nearest block course that is lower than the height specified.
- .4 Where a conflict of device mounting occurs, the Contractor shall contact the Engineer for clarification.

## **5. DISTRIBUTION EQUIPMENT**

### **5.1 General**

- .1 The Electrical subcontractor shall provide the distribution equipment required for the complete installation.
- .2 Equipment shall be delivered to the site and shall be protected all around with a plastic covering. Additional onsite protection must be provided to keep the equipment protected from the elements and other trades. If there is any sign of rusting or corrosion or severe physical abuse on the equipment, the affected parts shall be replaced at no cost to the Owner.
- .3 All distribution equipment shall have tested and approved series ratings for fault currents and shall have identifying labels.
- .4 All distribution equipment shall have lugs with termination temperatures rated at 75 deg C minimum.

### **5.2 Panels**

- .1 Provide surface or recessed panels of type, voltage, ampere capacity, number of poles, branch circuit, capacity, etc., as indicated.
- .2 All panel bus bars shall be tin plated aluminum unless specifically noted otherwise.
- .3 Panels shall have a hinged door with flush lock for access only to the breakers.
- .4 Balance all panels to give as near as possible equal current in all phases under full load conditions.
- .5 Provide 200% rated neutral lugs where outlined.
- .6 Provide a minimum of two 1.5", (41mm) spare conduits from each recessed panel to the nearest accessible ceiling space or utility space. Cap conduits and label as "spare."

### **5.3 Disconnect Switches**

- .1 Disconnect switches shall have visible blades in the off position, quick make, quick break mechanism and shall have steel reinforced clips. All switches shall have ample gutter space for top or bottom wiring.
- .2 Provision for padlocking in on-off switch position by one lock.
- .3 Switch mechanically interlocked door with front accessible defeat to prevent opening when handle in ON position.
- .4 Switches with pull out style contact devices shall not be permitted.
- .5 Coordinate with HVAC equipment to procure a suitably sized disconnect switch for the rooftop condensing units.

#### 5.4 Breakers

- .1 Unless indicated otherwise, breakers shall be moulded case type, thermal-magnetic, ambient temperature compensated, of the frame size and with trip settings as indicated on the drawings. Breakers mounted in panels shall be bolt-on type.
- .2 All breakers shall be fully rated for the fault current levels indicated on the single line diagram. Alternatively all breakers shall have tested and approved series ratings for fault current levels indicated and shall have identifying labels.
- .3 Breakers serving transformers shall be of a type to withstand the inrush current. Manufacturer shall provide time-current curves for all such breakers demonstrating the ability to withstand transformer inrush currents for the specific transformer being supplied for the project.
- .4 Unless otherwise noted all breakers shall be rated minimum 10kA symmetrical interrupting capacity at 208V and 18kA at 600V.
- .5 All breakers indicated as "spare" shall be installed in the "OFF" position.
- .6 Breakers serving fire pumps shall be painted red and shall be lockable in the ON position.
- .7 Breaker supplier shall allow for up to 10% of breakers to be returned and traded for equal breakers of two standard ampacity sizes higher or lower than that originally provided at no additional cost to the project.
- .8 The manufacturer shall arrange breakers in panels in the order indicated on the schedules. Rearrangement of breakers on site is not recommended.

#### 5.5 Contactors

- .1 Power contactors shall be of the voltage, ampacity and number of poles as indicated on the drawings. Contacts shall have mixed load ratings (lighting and motor) and be electrically held.

#### 5.6 Transformers

- .1 Three phase transformers 45kVA and larger shall be Class 220 insulation system rating, 150 deg C temp rise, less than 4.5% regulation at unity power factor, min 4.0% impedance, copper wound, not T wound. They shall be of the voltage and size as shown on the drawings.
- .2 Transformers shall be rated NEMA 3R.
- .3 Dry type transformers shall comply with CSA C802.2-12 or 18 for energy efficiency and Schedule 6 of the Green Energy Act, whichever is most stringent.
- .4 Transformers shall have internal vibration absorbing pads and optional external moulded neoprene and steel vibration isolators.
- .5 Neutral generated by transformers shall be tied to building ground with ground conductor sized to code requirements.



- .6 Transformers shall have four (4) 2.5% full capacity taps, two (2) FCAN and two (2) FCBN.
- .7 Connections on HV and LV sides shall be flexible conduit or equivalent.
- .8 Transformers shall be mounted so that there is a minimum of 6", (150mm) clear space between unit and any adjacent noncombustible surface.
- .9 Provide minimum 1m (40") clearance on "front" side of transformer where terminations are made.
- .10 Sound pressure noise levels shall comply with CSA C9: 10-50kVA: 45dBa at 1.0m, 51-150kVA: 50dBa at 1.0m.
- .11 Electrical room layout has been based upon Hammond transformer dimensions. If an alternate manufacturer is selected from the Alternate Manufacturers List, the Electrical Subcontractor shall ensure that the alternate products will fit into the space allocated while maintaining the proper clearances.
- .12 Warrantee period shall be five years from date of Substantial Performance.

#### 5.7 Grounding and Bonding

- .1 Include grounding and bonding as required by OESC, ESA Inspection Department, and as shown on drawings.

#### 5.8 Motor Protection and Control

- .1 General:
  - a. Each starter shall include manual reset thermal overload elements, one for each power supply line, i.e., three for three-phase motors. Overloads shall be sized to suit the connected load.
  - b. All starters and disconnects shall be listed as "Suitable as Motor Disconnects".
  - c. All starters shall be NEMA rated with a minimum Size 0 and be rated at minimum 15A continuous current. IEC design starters shall not be permitted.
  - d. Motor starters shall be rated for minimum 10kA withstand rating and shall not be less than the available fault current.
- .2 Manual motor starters:
  - a. Heavy duty toggle mechanism.
  - b. Thermal overload relay and red neon pilot light.
  - c. Rated to match the motor requirements.
  - d. In finished areas, starters shall be flush mounted with cover plates coloured to match other wiring devices. In other areas provide enclosures to suit specific application.
- .3 Combination type starters:
  - a. Provide combination starters complete with fused disconnect switch protection suitable for use with Class J fuses.

- b. Provide two sets of normally open and normally closed extra auxiliary contacts in each starter for connection to the building automation system by the controls subcontractor.
- c. Integral control voltage transformer with fused secondary, rated for min 50VA. All control wiring and devices shall function on a 120VAC control circuit unless indicated otherwise.
- d. Thermal overload protection.
- e. Green pilot lamp indicating starter is energized.
- f. Door mount overload reset switch.

### 5.9 Execution

- .1 Wall mounted distribution equipment shall be mounted in an approved manner. The equipment shall be mounted in a well-organized and planned arrangement. The backboard shall be mounted on a non-combustible surface.
- .2 Concrete housekeeping pad shall be provided for the transformer by the Electrical Subcontractor.
- .3 Install disconnecting means within sight and less than 9m from motor loads.
- .4 Install disconnecting means within sight and less than 3m from air conditioning and refrigeration equipment.
- .5 Install transformers in level upright position.
- .6 Loosen isolation pad bolts until no compression is visible.
- .7 Starters and disconnect switches installed in areas that are accessible by the public shall be lockable in the on and off positions.
- .8 Panels shall generally be wall mounted. Provide strut standoffs or strut frame where required if wall surface is not uniform, or where wall structural capacity is not adequate to support weight of panel.

## **6. LIGHTING**

### **6.1 General**

- .1 Supply and install lighting with all accessories and lamps as shown in "LIGHTING FIXTURE SCHEDULE," and as described.
- .2 Submit Shop Drawings containing the following information:
  - a. Picture of fixture, fixture model number, fixture colour.
  - b. Lens data, mounting details, photometric data.
  - c. Fixture manufacturer (include address and telephone number).
- .3 No allowance or change in fixture type will be permitted for the failure of the Electrical Subcontractor to allow sufficient time for the delivery of the fixtures when required to the site. Should the approved fixtures not arrive on time, this subcontractor shall supply and install temporary fixtures at no cost to the Owner and shall replace same with the approved fixtures when they arrive and make good all surfaces disturbed by this operation.

### **6.2 Solid State (LED) Lighting**

- .1 Quality Assurance
  - a. Luminaires shall be of uniform quality and appearance.
  - b. Manufacturers of LED luminaires shall demonstrate a suitable testing program incorporating high heat, high humidity and thermal shock test regimens to ensure system reliability and to substantiate lifetime claims.
  - c. The LED fixture assembly/manufacturing facility shall be ISO 9001 certified and produce product in compliance to RoHS.
  - d. At time of manufacture, electrical and light technical properties shall be recorded for each luminaire. At a minimum, this should include lumen output, CCT, and CRI. Each luminaire shall utilize a unique serial numbering scheme. Technical properties must be made available for a minimum of 7 years after the date of manufacture.
  - e. Luminaires shall be provided with a 5 year warranty covering, LEDs, drivers, paint and mechanical components.
  - f. A Lighting Facts label, as established by the United States Department of Energy, is required for all products.
- .2 Material and specifications for each luminaire are as follows:
  - a. Each Luminaire shall consist of an assembly that utilizes LEDs as the light source. In addition, a complete Luminaire shall consist of a housing, LED array, and electronic driver (power supply).
  - b. Each Luminaire shall be rated for a minimum operational life of 60,000 hours of operations at an average operating time of 10.5 hours.
  - c. The rated operating temperature range shall be -40°C to +40°C.
  - d. Photometry must be compliant with IESNA LM-79-08 and shall be conducted at 25°C ambient temperature.
  - e. Each Luminaire shall meet all parameters of this specification throughout the minimum operational life when operated at the average nighttime temperature.

- f. The individual LEDs shall be constructed such that a catastrophic loss or the failure of one LED will not result in the loss of the entire Luminaire.
- g. Luminaire shall be constructed such that LED modules may be replaced or repaired without replacement of whole Luminaire.
- h. Each Luminaire shall be listed with CSA or cUL under UL1598 for luminaires.

### .3 Electrical Requirements

- a. Maximum power consumption allowed for the Luminaire shall be determined by application. The Luminaire shall not consume power in the off state.
- b. The Luminaire shall operate from a 60 HZ  $\pm$ 3 HZ AC line over a voltage ranging from 108 VAC to 350 VAC. The fluctuations of line voltage shall have no visible effect on the luminous output.
- c. (The Luminaire shall have a power factor of 0.90 or greater.
- d. Total harmonic distortion (current and voltage) induced into an AC power line by a Luminaire shall not exceed 20 percent.
- e. The Luminaire on-board circuitry shall include surge protection devices (SPD) to withstand high repetition noise transients as a result of utility line switching, nearby lightning strikes, and other interference.
- f. The LED circuitry shall prevent visible flicker to the unaided eye over the voltage range specified above.
- g. LED Drivers must meet Class A emission limits referred in Federal Communications Commission (FCC) Title 47, Subpart B, Section 15 regulations concerning the emission of electronic noise.
- h. Drivers shall have a Class A sound rating.

### .4 Photometric Requirements

- a. Optical assemblies shall have a minimum efficiency of 85% regardless of distribution type. All optical assemblies will be mounted parallel to the ground, aimed in the same direction and shall provide the same optical pattern such that catastrophic failures of individual LEDs will not constitute a loss in the distribution pattern.
- b. All photometric data will be measured by the IESNA LM-79-08 standard and formatted per IESNA LM-63-02 as an electronic .ies file.
- c. The illuminance shall not decrease by more than 30% over the expected operating life. The measurements shall be calibrated to standard photopic calibrations.
- d. The luminaire shall have a correlated color temperature (CCT) range of 3,000K to 4,500K as indicated in the Lighting Fixture Schedule. The color rendition index (CRI) shall be 80 or greater.
- e. Exterior luminaires shall not allow more than 10 percent of the rated lumens to project above 80 degrees from vertical. The Luminaire shall not allow more than 2.5 percent of the rated lumens to project above 90 degrees from vertical. Backlight and Glare ratings calculated as per IESNA TM-15.

### .5 Thermal Management

- a. The thermal management (of the heat generated by the LEDs) shall be of sufficient capacity to assure proper operation of the Luminaire over the expected useful life.
- b. The LED manufacturer's maximum thermal pad temperature for the expected life shall not be exceeded.

- c. Thermal management shall be passive by design. The use of fans or other mechanical devices shall not be allowed.
  - d. The Luminaire shall have a minimum heat sink surface such that LED manufacturer's maximum junction temperature is not exceeded at maximum rated ambient temperature of 40 degrees Celsius (supply Heat test).
  - e. The heat sink material shall be aluminum.
- .6 Physical and Mechanical Requirements
- a. The Luminaire shall be a single, self-contained device, not requiring on-site assembly for installation. The power supply for the Luminaire shall be integral to the unit.
  - b. The assembly and manufacturing process for the LED Luminaire shall be designed to assure all internal components are adequately supported to withstand mechanical shock and vibration from high winds and other sources.

### 6.3 Exit Signage

- .1 New exit signs shall be provided under a future project.

### 6.4 Execution

- .1 Provide all fastenings, supports etc. to install in an appropriate and approved manner. Adequately support all ceiling mounted fixtures, from the building structure. Use safety chains for all accessible ceilings. The accessible ceiling shall not solely support the fixture. The requirement for independent support for fixtures may be waived only if the accessible ceiling manufacturer provides written confirmation that the ceiling has been designed to carry the load.
- .2 Fasten fixtures to studs, joists, furring channel or other structural ceiling framing with screws. Drill holes in fixtures if required for alignment to ceiling structure. Coordinate with ceiling installed to ensure sufficient structure is provided for the fixtures. Toggle bolts or drywall anchors alone is insufficient.
- .3 All fixtures installed in/on acoustic tile in T-bar ceilings shall have safety chains. All fixtures recessed into T-bar ceilings shall be provided with grid clips, or fly-out tabs to restrict the fixture from being pushed up during maintenance.
- .4 All fixtures in T-bar ceilings shall be wired with sufficient spare conductor coiled in the ceiling to allow fixtures to be moved 4'-0", (1.2m) in any direction.
- .5 All fixtures recessed into ceilings serving as fire-rated separations shall be approved for such use, and shall be provided with suitable enclosures. The Electrical Subcontractor shall be responsible for providing the enclosures. Suggested product may be procured from Tenmat <https://www.tenmatusa.com>
- .6 Any boxes around any recessed fixture shall be constructed to provide the necessary clearances to suit the manufacturer's recommendations. The Electrical Subcontractor shall verify the necessary clearances with the manufacturer.
- .7 Recessed fixtures shall not be installed in an insulated ceiling unless approved for that installation.

- .8 All cabling associated with lighting control system shall be CMP CAT5e green. Performance shall meet or exceed that of Nexans HyperPlus 5e Plenum Part Number 10032232.
- .9 Coordinate position of lighting fixtures in mechanical areas with mechanical duct work and equipment. Modify installation to suit.
- .10 Suspended light fixtures in areas near ceiling fans or supply air diffusers shall be rigidly mounted, or suspended with two chains, set at an angle so as to eliminate sway.
- .11 Provide an adjustable hanger system for areas requiring fine adjustment of fixture suspensions. System shall be Gripple, or approved alternate, rated for fixture mass with minimum 5:1 safety factor.
- .12 The location of fixtures as shown on the drawings are approximately correct, but the Consultant reserves the right to alter the location of any number of them up to 120", (3.0m) without incurring extra costs, provided the request is made before the fixture is installed.

## **7. EMERGENCY LIGHTING (UNIT EQUIPMENT)**

### **7.1 General**

- .1 Supply and install an emergency lighting system consisting of the following, to activate and provide egress lighting in the event of a power failure:
  - a. Battery-backed lighting fixtures, conduit, wiring etc.
- .2 Batteries to automatically recharge after normal power is restored.
- .3 Provide complete working system utilizing products as outlined in "LIGHTING FIXTURE SCHEDULE."
- .4 Equipment shall conform to CAN/CSA-C22.2 No. 141-10 (or latest edition).

### **7.2 Products**

- .1 Emergency Lighting Units
  - a. High quality, corrosion, flame and vandal resistant, polycarbonate housing.
  - b. Vandal resistant latch clips.
  - c. Ceiling or wall mounted. Adjust the position of the LED board for all wall mount applications to direct lighting down.
  - d. IP65 rating. Suitable for wet location installations.
  - e. Auto-test circuitry. External test switch for momentary test operation.
  - f. Sealed Ni-MH batteries for minimum 90 minute emergency illumination.
  - g. Nine year pro-rata warranty on the assembly. Ten year battery warranty.

### **7.3 Execution**

- .1 Self-Contained
  - a. Orient ceiling mounted fixtures perpendicular to axis of corridor.
- .2 Refer to previous specification section for provision of spare emergency lighting parts.
- .3 Perform an Emergency Lighting and Exit Sign test as soon as the systems are operational. Test shall indicate the following in chart form on Company letterhead:
  - a. Building name and location.
  - b. Physical location of each remote device.
  - c. The device designation, i.e, EA, EXB, etc.
  - d. Battery pack designation, manufacturer and name plate data.
  - e. Proper operation under normal AC power.
  - f. Duration of operation under emergency DC power.
  - g. Current load check on each output circuit.
  - h. Location and voltage at most remote fixture.
  - i. Charging current at the end of the test.
  - j. Date of testing.
  - k. Signature and name of testing individual.

- .4 Once system is free of defects, remove all AC and DC power sources at a time suitable to the Owners, so as to schedule subsequent self-diagnostic Auto-Tests for minimal distraction to building occupants.

**END OF SECTION**



## **1. DIVISION 27 COMMON WORKS**

### **1.1 General Requirements**

- .1 The Procurement and Contracting Requirements as outlined under Division 00, and the General Requirements as outlined under Division 01, and all addenda thereto shall apply to and govern all portions of the communications work.
- .2 Reference Division 26 and Division 28 for additional requirements.

### **1.2 Work in Contract**

- .1 The Electrical Subcontractor shall be responsible for the supply and installation and/or modification of the following systems, including all equipment, associated cabling, terminations, testing, programming, integration and commissioning:
  - a. Pathways for communications, electronic safety and security.
  - b. Assistive listening.
  - c. Audio/Visual.
- .2 The Electrical Subcontractor shall obtain the services of qualified Communications Subcontractor(s) for the satisfactory completion of the work, and shall carry all such subcontractor costs in the bid.
- .3 All rough-in work shall be performed by Division 26. All final terminations and programming shall be performed by the appropriate Communications Subcontractor.
- .4 The Communications Subcontractor shall warrant any equipment installed under this specification to be free from defects for a period of two years from date of final acceptance.
- .5 The subcontractors shall ensure that all communications cabling in spaces being used as a return air plenum is totally enclosed in non-combustible raceways, or is FT6 rated (also known as Communications Media Plenum, or CMP).
- .6 All systems and components shall be ULC listed.

### **1.3 Work by Others**

- .1 All equipment, associated cabling, termination, testing, programming, integration and commissioning of the following systems shall be supplied and installed by others under the specified allowance(s):
  - a. Computer (data).
  - b. Telephone (voice).
  - c. Public address.
- .2 The Electrical Subcontractor shall coordinate with the successful subcontractor(s) to provide the proper infrastructure (rough-in work) for the installations.

## **2. PATHWAYS FOR COMMUNICATIONS AND SECURITY SYSTEMS**

### **2.1 General**

- .1 This section will generally refer to empty conduits, sleeves, junction boxes, etc. associated with the following systems:
  - a. Communications, i.e., computer (data), telephone (voice), public address, audio visual and assistive listening.
  - b. Electronic Safety and Security.
- .2 Provide all material and labour necessary for a complete installation of pathways.

### **2.2 Installation - Interior**

- .1 Unless otherwise noted, all outlets shall be single gang deep boxes. Each single gang box shall be provided with 0.75" (21mm) conduits. Outlets that indicate more than two drops shall feature 1.0" (27mm) conduits. Allow for punching holes in metal outlet boxes if available knockouts cannot meet this specification.
- .2 All conduit runs shall follow building grid lines and shall be concealed. Conduits installed below the floor slab need not follow building grid lines.
- .3 EMT bushings shall be Arlington AL-EMTxx series, size to suit conduit specified.

### **2.3 Cabling Hangers**

- .1 Multiple use "J" shaped hanger to provide secure containment of low voltage communications cables.
  - a. Pre-galvanized finish.
  - b. Powder coated paint colours include white, brown, blue, black, green, orange, red, yellow and grey.
  - c. 4" (100mm) size capable of supporting 300 4-pair UTP, CAT5e or 2-strand fibre cable, or 185 CAT6.
  - d. Quick release cable retainer.
- .2 Hangers shall be Cooper B-Line Catalog No. BCH64 series, or approved alternate, complete with Qwik-Latch cable retainers.
- .3 Units shall be wall mounted (-1D) where ever possible. Where not possible, units shall be suspended from the structure (-2D).
- .4 Installation of power wiring in hangers shall not be permitted.
- .5 Hangers shall be spaced at 40" (1.0m) intervals.
- .6 Coordinate exact location of hangers onsite with Mechanical Contractor to avoid conflicts with piping, ductwork etc.

### **2.4 Execution**

- .1 Provide a conduit from each outlet box to the nearest accessible ceiling space. Conduit shall extend minimum of 6.0" (150mm) above ceiling and shall have smooth 90 degree bends. Do not terminate conduits above non-accessible ceiling systems.
- .2 Conduits for Assistive Listening cabling is recommended to be contained within each room (not stubbed to the corridor). Maximum of 15m cable lengths.
- .3 Provide a blank cover plate on each outlet of the same colour and material as described in the wiring devices section.
- .4 All empty conduits and raceway systems shall be provided complete with nylon pull tapes and plastic bushings.
- .5 Pull tapes shall be suitably fastened to the ends of each conduit to prevent accidental pull outs.

### **3. ASSISTIVE LISTENING**

#### **3.1 Scope of Work**

- .1 The Electrical Subcontractor shall be responsible for the provision of a complete assistive listening system including the supply and installation of all equipment, cabling, and field devices.
- .2 All final terminations and programming shall be performed by the manufacturer's authorized representative.
- .3 The subcontractor is to coordinate with the Owners staff for the start-up of the system.
- .4 The assistive listening systems are to be delivered to the WRDSB Education Centre, 51 Ardelt Avenue, Box 58, Kitchener, Ontario, to be tagged and entered into their system. The Electrical Subcontractor is to allow for delivery to and picking up of the system after it has been tagged at the Education Centre. The system shall then be taken back to the site for installation.

#### **3.2 Quality Assurance**

- .1 The subcontractor shall have a factory trained service department on call twenty-four hours a day, 365 days a year, to service the specified product.
- .2 The installing subcontractor may be asked to provide a reference list of five similar sized projects installed by the subcontractor including contacts and telephone numbers.

#### **3.3 Products**

- .1 Each individual teaching space shall consist of the following Lightspeed Topcat components:
  - a. One (1) Model No. TCA ceiling-mounted audio base station. Provide plug-in power adapter and 15.24m plenum rated DC power cable kit.
  - b. Two (2) Model No. FM flexmike pendent-style wireless microphones. Provide AA NiMH rechargeable battery pack and lavalier cord.
  - c. One (1) Model No. FMCC cradle charger for flexmikes. Provide plug-in power adapter.
  - d. One (1) Model No. Media Connector wireless audio transmitter/receiver to integrate with classroom audio sources and send/receive the wireless signal. Provide plug-in power adapter.
  - e. One (1) wall-mounted, black, glass shelf.
- .2 Additional Lightspeed Topcat equipment for larger spaces:
  - a. One (1) Model No. 955 Access audio amplifier and wireless receiver/transmitter. Provide plug-in power adapter.
  - b. Two (2) Model No. DRQ auxiliary ceiling speakers.

#### **3.4 Execution**

- .1 Typical Teaching Space
  - a. Refer to the 'Classroom Audio/Video Rough-in Detail' for installation details.

- b. Refer to the 'Classroom Audio/Video Cabling Schematic' for cabling details.
  - c. Locate and install the Topcat Access on the ceiling, centrally within the room. Install plug-in power supply and plenum rated DC cabling from the power supply to the Topcat Access.
  - d. Locate and install the auxiliary speakers along centre axis of each room, one on each side of the Topcat Access, for optimal audibility.
  - e. Preferred location of the wall-mounted shelf is above millwork shelves to prevent accidental contact.
- .2 Provide custom stainless steel decora strap for the HDMI and 3.5mm audio inputs. Install in a two-gang box with a data drop in the second gang.
  - .3 Provide 27mm riser conduits for cable installation. Cables shall only be run exposed above accessible ceilings.
  - .4 Outlet boxes serving inputs shall be bonded to ground.
  - .5 Provide cable ties to neatly route cabling above accessible ceilings where indicated. Do not lay cables on top of ceiling tiles or lighting fixtures.
  - .6 Size and quantity of conductors shall be in accordance with manufacturer's requirement for cabling.
  - .7 All cabling shall be Communications Media Plenum (CMP) rated.
  - .8 The assistive listening systems shall not be integrated into the school public address system.

### 3.5 Field Quality Control

- .1 The work of this section shall not be considered to be complete until all systems and component parts have been tested and found to be in satisfactory operating condition.

#### **4. AUDIO/VISUAL SYSTEMS**

##### **4.1 Projectors**

- .1 Projectors and associated mounting hardware shall be supplied in-contract, complete with associated remote control and batteries, all for installation by the Electrical Subcontractor.
- .2 Projection screens shall be provided by others.
- .3 Provide the following in a typical teaching space:
  - a. HDMI Decorator Frame. Refer to Assistive Listening specification.
  - b. HDMI cable.
    - i. Plenum rated (CMP).
    - ii. Length to suit, but less than 15m.
    - iii. 10.2 Gbps bandwidth.
    - iv. 24 AWG.
  - c. Adjustable Projector Drop Pole: Chief CMS Series. Provide suitable length pole such that the projector is level with the top of the screen.
  - d. Projector Mount: Chief RPAU-W.
  - e. Mounting Plate: Chief CMS440. Fasten safety cable to structure.
  - f. Plenum Rated Box: Chief CMA470. Secure to top of mounting plate.
  - g. Projector: WXGA laser projector Optoma Model ZW400 complete with remote control and batteries.

##### **4.2 Execution**

- .1 Installations instructions shall be obtained from the system manufacturer prior to installation.
- .2 Prior to installation, verify optimal distance from projectors to screen with projector manufacturer's specifications. Based on proposed equipment, maintain 3660mm (12ft) between projector and screen. Projector shall be no more than 100mm (4") off centre of the screen.
- .3 Mount duplex receptacle above finished ceiling to power the projector.
- .4 Provide CMP HDMI cable from the projector to the video outlet. Refer to the floor plans for the location of the video outlet.
- .5 All projectors are subject to ambient light conditions. It is recommended lighting and window coverings be adjusted for optimal projector performance.

#### **END OF SECTION**

## **1. DIVISION 28 COMMON WORKS**

### **1.1 General Requirements**

- .1 The Procurement and Contracting Requirements as outlined under Division 00, and the General Requirements as outlined under Division 01, and all addenda thereto shall apply to and govern all portions of the electronic safety and security work.
- .2 Reference Division 26 and Division 27 for additional requirements.

### **1.2 Work in Contract**

- .1 The Electrical Subcontractor shall be responsible for the supply and installation and/or modification of the following systems, including all equipment, associated cabling, terminations, testing, programming, integration and commissioning:
  - a. Fire alarm and detection.
- .2 All rough-in work shall be performed by Division 26.
- .3 The subcontractors shall ensure that all security cabling in spaces being used as a return air plenum is totally enclosed in non-combustible raceways, or is FT6 rated (also known as Communications Media Plenum, or CMP).
- .4 All systems and components shall be ULC listed.

## **2. FIRE ALARM AND DETECTION**

### 2.1 Scope of Work

- .1 This specification provides the requirements the modification of the existing addressable fire alarm and detection system.

### 2.2 Quality Assurance

- .1 Edwards has been specified as the manufacturer and as such, sets the standard of quality and type of equipment to be provided.
- .2 Each and all items of the fire alarm and detection system shall be covered by a one-year parts and labour warranty covering defects resulting from faulty workmanship and materials.
- .3 All equipment shall be new and unused. All components and systems shall be designed for uninterrupted duty. All equipment, materials, accessories, devices, and other facilities covered by this specification or noted on contract drawings and installation specifications shall be the best suited for the intended use and shall be provided by a single manufacturer or if provided by different manufacturers recognized as compatible by both manufacturers and ULC.
- .4 Installing contractor shall be certified by a program or course acceptable to the Office of the Fire Marshal. Evidence of membership in the ECAO Fire Alarm and Protection Certification Program, or proof of registration as a CFAA Fire Alarm Technician may be requested.

### 2.3 Control Panel (FACP)

- .1 The existing fire alarm control panel shall remain.
- .2 The system program shall meet the requirements of this project, current codes and standards, and satisfy the local authority having jurisdiction.
- .3 Provide optional relay cards as required to support all ancillary devices and equipment as described herein.

### 2.4 Remote Annunciators

- .1 Existing annunciator(s) shall remain. Modify to reflect the new zoning arrangement.

### 2.5 Passive Graphic

- .1 Updated passive zoning graphic(s) shall be provided by others.

### 2.6 Addressable Initiating Devices

- .1 Addressable Devices - General
  - a. Each remote device shall have a microprocessor with non-volatile memory to support its functionality and serviceability.



- b. Each device shall be capable of electronic addressing, either automatically or application programmed assigned, to support physical/electrical mapping and supervision by location.

.2 Addressable Detectors

- a. The system addressable detectors shall be capable of full digital communications using both broadcast and polling protocol.
- b. Each detector shall have an integral microprocessor capable of making alarm decisions based on parameter information stored in the detector head.
- c. Each detector shall have a separate means of displaying communication and alarm status.
- d. The detectors shall be suitable for mounting on any Signature Series detector mounting base.
- e. The addressable detectors and devices shall be as follows:
  - i. Smoke, SIGA-OSHD.
  - ii. Heat Rate-of-Rise, SIGA-HRD. (57C)/Rate of Rise (9C per minute).
  - iii. Duct Smoke, SIGA-SD. Provide sampling tube and remote alarm LED.
  - iv. Zone Isolator, SIGA-IM2.
- f. All addressable detectors shall be suitable for use with the following bases:
  - i. Standard, SIGA-SB.

.3 Addressable Modules

- a. It shall be possible to address each Intelligent Signature Series module without the use of DIP or rotary switches.
- b. The personality of multifunction modules shall be programmable at site to suit conditions and may be changed at any time using a personality code downloaded from the Analog Loop Controller.
- c. Input and output circuit wiring shall be supervised for open and ground faults.
- d. The addressable module devices shall be as follows:
  - i. Control Relay, SIGA-CR (form C contacts, 2A @24VDC, 0.5A @120VAC).
  - ii. Control Relay, SIGA-CRH (form C contacts, 6A @24VDC, 7A @120VAC).

2.7 Conventional Initiating Devices

- .1 The system shall possess the capability of incorporating the following conventional system devices:
  - a. Combination Fixed Temperature/Rate-of-Rise Heat Detectors:
    - i. System Sensor 5601A (135 deg F/57 deg C).

2.8 System Accessories

- .1 Provide independent devices as follows:
  - a. Addressable Fire Detector Guard, SIGA-GRD. Include mounting flange where required.
  - b. End of line device cover plates, Model No. EOL-P1, white.

2.9 Signaling Devices

- .1 All appliances shall be ULC Listed for Fire Protective Service.
- .2 All appliances shall be of the same manufacturer as the Fire Alarm Control Panel to ensure absolute compatibility between the appliances and the control panels, and to ensure that the application of the appliances is done in accordance with the single manufacturer's instructions.
- .3 Horns
  - a. Genesis model G4ARF, red, wall mounted, field selectable audibility.
- .4 Horn/Strobes wall mounted
  - a. Genesis model G4AVRF, red, wall mounted, field selectable audibility and light intensity levels (15, 30, 75, 110cd).
- .5 Strobes
  - a. Genesis model G4VRF, red, wall mounted, field selectable light intensity levels (15, 30, 75, 110cd).

#### 2.10 Ancillary Devices

- .1 Electromagnetic Door Holders - 24VAC or 24VDC
  - a. Wall mounted, concealed wiring door holder, Cat. No. 1504-AQ.
  - b. Wall mounted, surface wiring door holder, Cat No. 1508-AQ.

#### 2.11 Fire Alarm Monitoring Equipment (FAME)

- .1 Existing panel shall remain to allow for offsite monitoring of the fire alarm and detection system.

#### 2.12 Sequence of Operation

- .1 The system shall continue to function so that operation of any alarm initiating device shall cause the following:
  - a. Signal devices to operate throughout building at the evacuation alert rate. Operation of a general alarm station key switch or an automatic evacuation timer set at five minutes shall cause all signals to sound evacuation.
  - b. Transmit an alarm signal to remote monitoring agency.
  - c. Display an event type, alarm time, and a location message for each active device or zone at control panel and at remote annunciators.
- .2 The system shall continue to function so that operation of any supervisory initiating device shall cause the following:
  - a. Internal signal to sound at the control panel and remote annunciators.
  - b. Display a location message for active device(s) at the control panel and remote annunciators.

- c. Transmit a supervisory signal to remote monitoring agency.
- .3 Program interlocks with all ancillary equipment as follows:
- a. Door holders: Release on alarm.
  - b. Fire smoke dampers: Close on alarm or any smoke detector associated with the damper or the associated air handling unit.
  - c. HVAC equipment: Shut down on alarm or local duct smoke detector.
  - d. For equipment system interlocks not referenced above, contact consultant for clarification.
- .4 Program initiating devices as follows:
- a. Alarm:
    - i. Smoke detectors.
    - ii. Heat detectors.
  - b. For equipment system interlocks not referenced above, contact consultant for clarification.
- .5 Indicate trouble condition at control panel and all remote annunciator for the following conditions:
- a. Field wiring open circuit.
  - b. Field wiring ground fault.
  - c. Battery disconnect.
  - d. Low battery.
  - e. AC power failure.
- .6 Program signal devices as follows:
- a. Single stage operation.
  - b. Temporal 3-3-3 pattern for alarm.
  - c. Set at maximum volume unless noted otherwise. Adjust to lower volume settings only if maximum permitted threshold is exceeded.
- .7 Duct detectors and smoke detectors associated with adjacent smoke dampers shall be programmed to activate the initiating zone on the floor where the device is located and the associated air handling equipment zone.

### 2.13 Installation

- .1 General Installations
- a. The entire system shall be installed in accordance with CAN/ULC-S524-14 and approved manufacturers manuals and wiring diagrams. The Electrical Subcontractor shall furnish all conduit, wiring, outlet boxes, junction boxes, cabinets and similar devices necessary for the complete installation. All wiring shall be of the type recommended by the OESC, approved by local authorities having jurisdiction for the purpose, and shall be installed in dedicated conduit throughout.
  - b. Install all initiating circuit wiring and all signal circuit wiring in separate raceways.

- c. End of Line resistors shall be furnished as required for mounting as directed by the manufacturer. Lamacoid labels shall be fastened to the front face of each EOL.
- d. Panel and annunciator zone labels shall be typed. Hand written labels shall not be permitted.
- e. Provide all programming and labels that reference room names or numbers to reflect the finalized Owner designated room names/numbers. Do not duplicate the room names/numbers indicated on the drawings.
- f. All wiring shall be minimum #14 AWG copper with 300V insulation rating, unless specifically noted otherwise.
- g. All device outlet boxes shall be selected to suit manufacturer's equipment and shall be coordinated prior to rough in.

.2 Initiating Installations

- a. Locate and install all isolation modules and connect to data loop wiring.
- b. Locate and install all initiating circuits and detectors and connect to zone wiring.
- c. Install spot type fire detectors on ceiling unless otherwise specified herein with minimum and maximum distances as required for the respective type of detector.
  - i. Mount at highest point where variations in ceiling height exist.
  - ii. Maintain a clear space of at least 18" (450mm) on the ceiling, below and around the fire detector.
  - iii. Maintain a horizontal minimum of 36" (900mm) between a fire detector and the peak of a sloped ceiling.
  - iv. Fire detectors shall not be located a direct air flow or within 18" (450mm) from an air supply or exhaust outlet.
- d. Install duct detector sampling tubes in straight section of duct to manufacturer's recommendation. Install so that the smoke detector and sampling tube are accessible for servicing. Obtain actual duct dimensions onsite prior to ordering air sampling tubes.

.3 Signaling Installations

- a. Locate and install all signaling devices and connect to notification circuit. Provide suitable back boxes and back plates for signaling appliances, surface or recessed type to suit the specific application.
- b. Provide adequate signal circuit wiring so that circuits are not loaded beyond 65%, regardless of the zoning arrangement indicated on the plans.
- c. Notification devices shall be set for temporal 3-3-3 pattern at maximum volume, unless noted otherwise.
- d. Programming for signal silence inhibit at 1.0 minutes, and automatic signal silence at 20 minutes.
- e. Install Signal Master Module on each signal circuit to synchronize output signals and to permit two stage operation of horn/strobe combinations with one pair of conductors.
- f. Visual notification devices shall be set for 30cd, unless noted otherwise.

2.14 Addressable System Notes

- .1 Locate and install all isolation modules and connect to data loop wiring. Locate zone isolators directly adjacent to zone separation at the point where it enters and exits the zone. There shall be a minimum of two zone isolators for each initiating zone. The location of the isolators

- may be adjusted onsite to optimize wiring. Clearly indicate isolator location on as-built drawings.
- .2 Data loop wiring shall be ULC S524 Style C.
  - .3 Data loop wiring shall exit/enter the control panel separate raceways and shall be separated 1.2m horizontally and 0.3m vertically thereafter.
  - .4 The following OBC zones need not have zone isolators:
    - a. Duct smoke detectors.
    - b. Other devices that are situated completely within a floor area.
  - .5 Data loop home run shall be permitted to pass through OBC zone/floor area/shafts without zone isolators. If devices are installed on the home run data loop, additional zone isolators shall be provided. Floor plans assume additional isolators will not be required.
  - .6 Addressable sensors and modules shall be connected directly to the data loop wiring. T-tapping off the data loop to form a Class "B" (zone wiring) circuit shall not be permitted.
  - .7 Zone wiring shall be #14/2 copper in a metallic raceway. AC90 (BX) cable is acceptable where specified. In all cases, the sensors and modules shall be located between the isolators serving the particular zone.
  - .8 Ensure data loop device count does not exceed 80%. Provide additional data loops if required. Proposed zone layout shall be prepared by the manufacturer and submitted to the Consultant for review.
  - .9 The address of each sensor and module shall be assigned by means of computer polling of the data loop(s) once installations are complete. The Electrical Subcontractor shall ensure that each addressable detector and module is assigned an identifying name in accordance with its installed location upon project completion.
  - .10 All signaling devices shall be fed direct from the control panel using Notification Appliance Circuits (NAC)s. NAC wiring shall be #14/2 copper in metallic raceway. AC90 (BX) cable is acceptable where specified.
  - .11 Connect addressable relay module outputs to the data loop nearest the module.
  - .12 Field measure all loads connected to addressable relay modules where the ratings on contacts is exceeded, provide additional relay suitable for the connected load.

#### 2.15 Field Quality Control and Programming

- .1 Perform tests in accordance with CAN/ULC-S537-13 Standard for the Verification of Fire Alarm Systems. Include testing as outlined in CAN/ULC-S536 latest addition.
- .2 Perform audibility tests if required by the local Building officials or if requested by the consultant.
- .3 Check annunciator panels to ensure zones are shown correctly.

- .4 The system shall be installed and fully tested under the supervision of trained manufacturer's representative. The system shall be demonstrated to perform all the functions as specified.
- .5 Verification(s) shall be performed by the manufacturer's representative authorized by the CFAA. Verification by the Contractor shall not be permitted.
- .6 Include for multiple verifications and integrated tests where the construction schedule warrants. Coordinate exact requirements with General trades.
- .7 System installation and operations shall be verified by the manufacturer's representative and a verification certificate presented upon completion. The manufacturer's representative shall be responsible for an on-site demonstration of the system operation and initial staff training as required by the Architect and/or Consulting Engineer.
- .8 Changes made to an existing fire alarm system shall require the following:
  - a. Verification of all new and modified devices.
  - b. Testing of all devices on the data loops affected. Software polling of devices on modified data loops shall not be acceptable.
  - c. Testing of one device on each zone data loop not affected.
- .9 System changes shall be verified by the manufacturer's representative and a verification certificate presented upon completion.

#### 2.16 Integrated Systems Testing of Fire Protection and Life Safety Systems

- .1 The Electrical Subcontractor shall retain the services of an Integrated Testing Coordinator (ITC) for all systems that are designed to operate together to achieve an overall fire protection and life safety objective, in accordance with OBC 3.2.10.
- .2 The Contractor shall not act as the ITC. The ITC shall be an independent provider that has been certified by ULC to perform this function and shall provide proof of certification prior to proceeding.
- .3 The Electrical Subcontractor shall cover the costs of the ITC and shall be responsible for coordinating and scheduling all affected parties including owners, operators, occupants, inspectors, consultants, installing subcontractors and verifying parties to participate in the testing.
- .4 The ITC shall be knowledgeable and experienced in the design, installation and operation of fire protection and life safety systems as well as associated building systems.
- .5 The ITC shall provide a project-specific, written report outlining the testing procedure and necessary functional results in accordance with CAN/ULC-S1001. A cause and effect matrix shall be used to outline the sequence of operation for the systems integration. The matrix shall be prepared by the ITC based on sequence of operation and fire alarm drawings and schematics. Specifically, this integrated testing plan shall outline the fire alarm system's integration with the following equipment and systems:
  - a. Hold-open Devices.
  - b. Smoke Control, including Air Handling.

- .6 Submit the integrated testing plan to the Engineer concurrently with shop drawings. Prior to testing, the Contractor shall provide all occupancy-related documentation to the ITC.
- .7 Unless otherwise outlined, the testing procedure shall consist of the functional operation of the device or system, i.e., testing of relay contacts alone is insufficient. Sample testing is also insufficient.
- .8 Once testing is completed, the ITC shall provide a signed report documenting the implementation of the systems integration. Include the report in the project close out for subsequent periodic systems testing as required.

**END OF SECTION**

# **24-7556-RFT - Waterloo-Oxford District Secondary School Family Studies Renovation & HVAC Upgrades**

Opening Date: March 28, 2024 4:00 PM

Closing Date: April 18, 2024 2:00 PM

---



## Schedule of Prices

\* Denotes a "MANDATORY" field

Do not enter \$0.00 dollars unless you are providing the line item at zero dollars to the Board.

## Bid Price Form

The amounts stipulated on the Bid Price Form(s) are intended to cover the cost of the complete Work as described in this Procurement and must remain fixed and firm for the term of the Contract unless otherwise specified in this Procurement.

All prices shall be in Canadian Funds, Free On Board (FOB) Destination, and Freight Prepaid (Board locations). and shall be exclusive of Harmonized Sales Tax (HST) but shall include all materials, labour, equipment, disbursements, expenses, insurance, bonding, customs charges, freight, shipping and handling costs, travel costs and all other charges of every kind attributable to the Work and Services provided.

## Bid Price includes Cash Allowance

Line Item	Description	Unit of Measure	Quantity	Bid Price *	Total
1	Waterloo-Oxford District Secondary School Family Studies Renovation & HVAC Upgrades as per scope of work	Lump Sum	1		
Subtotal:					

## Summary Table

Bid Form	Amount
Bid Price Form	
HST (13%)	\$ 0.00
Total Contract Amount:	

## Bid Questions

Bill S-211 - This enactment enacts the Fighting Against Forced Labour and Child Labour in Supply Chains Act, which imposes an obligation on certain government institutions entities to ensure measures are taken to prevent and reduce the risk that forced labour or child labour is used by suppliers or in their supply chains. The Board principles align with Bill S-211. Please confirm that your organization will comply with this Act. YES or NO. If no, please explain.

The Board will require General Contractors on the approved Roster List to have their IHSA - Certificate of Recognition (COR®) by January 2026. Although not mandatory for this bid opportunity, the Board requests bidders to respond to the question below YES or NO. By responding NO, you acknowledge the deadline requirement above. Does your company have a current IHSA - Certificate of Recognition (COR®)? - YES or NO

## Specifications

### Bidder's Contact Information

A Site Supervisor and Project Manager, assigned to manage and supervise the Work, must be named in this form. Personnel will be subject to approval by the Board and cannot be changed without prior written approval from the Board.

A dedicated Site Supervisor is required full-time for this project. If your company is awarded more than one project/contract, a different Site Supervisor is required for each project. In the event of this situation, you have the option to name and include a resume for an alternative Site Supervisor at this time.

If providing an alternative Site Supervisor with your submission, it is understood, that the alternative Site Supervisor will only be reviewed if the first Site Supervisor has already been accepted and working on another WRDSB project.

Note: resumes are required to be uploaded in the document section. Optional for alternative Site Supervisor

Title	Name *	E-mail *	Cell Phone Number *	
Project Manager				*
Site Supervisor				*
Optional - Alternative Site Supervisor in the event the Site Supervisor listed above is assigned to another WRDSB Project.				

### Documents

It is your responsibility to ensure the uploaded file(s) is/are not defective or corrupted and are able to be opened and viewed by the Owner. If the attached file(s) cannot be opened or viewed, your Bid Submission may be rejected.

Upload a resume for each person named in the Specification section.

- Project Manager - Resume \* (mandatory)
- Site Supervisor - Resume \* (mandatory)
- Optional - Alternative Site Supervisor - Resume (only if Site Supervisor #1 is assigned to another project prior to this award) (optional)

## **BONDING UPLOAD SECTION**

Refer to the Bonding Requirements Section of the Terms and Conditions.

Bonding is required if the project is equal to or greater than \$200,000.00. Note: The Bidding System has flagged these fields as mandatory. If your bid is less than \$200,000.00, please upload a pdf document stating: Not Applicable.

Bidders shall upload their electronically verifiable and enforceable (e-Bond) format for Bid Deposit Bond and Agreement to Bond separately in this section. If both Bonds are in the same pdf file, please upload it in both fields and indicate one is a "duplicate"

The date on the Bonds must be the Closing Date

Tender # and Project Title must be included on the Bonds

- Bid Deposit Bond \* (mandatory)
- Agreement to Bond \* (mandatory)

## Addenda, Terms and Conditions

I/We have read and understand this Bid Solicitation document, and agree to perform the Work required in accordance with this Bid

Solicitation document, including all addenda, at the price(s) detailed in the Bid.

I/We confirm that:

1. The person named in this Bid is authorized to sign and electronically submit this Bid through the Bidding System.
2. I/We meet all mandatory requirements of the Bid Solicitation document.
3. The bid will remain open for a specified acceptance period after the Closing Time. The Board may, at any time within this period, accept the Bid whether or not any other Bid has previously been accepted.
4. All prices provided in the Bid will remain fixed and firm for the duration of the term of the agreement, unless specified otherwise.
5. All prices provided in my/our Bid are in Canadian funds and include all charges of every kind attributable to the Work. Harmonized Sales Tax will be extra and not shown, unless specified otherwise.
6. To the best of my/our knowledge and belief:
  - a) the information provided in the Bid is correct; and
  - b) the Bid is made without any comparison of figures or arrangement with any other individual, corporation or person submitting a Bid for the same Work and is in all respects fair and without collusion or fraud.
7. I/We comply with the all applicable Board policies, provincial, and federal laws, and are aware of the Board's "Principles of Business Conduct" and will comply.
8. I/We agree and understand that the recommendation to award the Work may be subject to the approval from the Board as well as availability of funds.
9. I/We agree to be bound by the terms and conditions of the Bid Solicitation document and submit this Bid on behalf of the Bidder.

I have the authority to bind the Bidder.

The Bidder/Proponent is to declare any actual, potential or perceived conflict of interest that could arise from submitting the Bid/Proposal.

Do you have a potential conflict of interest?

Yes  No

The Bidder acknowledges and agrees that the addendum/addenda below form part of the Bid Solicitation Document.

Please check the box in the column "**I have reviewed this addendum**" below to acknowledge each of the addenda.

**File Name**

**I have reviewed the  
below addendum and  
attachments (if  
applicable)**

**Pages**

**There have not been any addenda issued for this bid.**